





	 Handyplug® - Multi-purpose Nylon anchors, ETA Approved	<ul style="list-style-type: none">  Handyplug® - Cheville universelle en nylon  Handyplug® - Universal- Langschaftdübel aus Nylon  Handyplug® - Taco UNIVERSAL de nylon  Handyplug® - Многофункциональные нейлоновые анкера 	188
	 Nylon frame anchor	<ul style="list-style-type: none">  Cheville cadre en nylon  Langschaftdübel aus Nylon  Taco de nylon para marcos  Нейлоновый рамный дюбель 	198
	 Metal frame anchors	<ul style="list-style-type: none">  Cheville cadre à douille  Hülsenanker aus Metall  Taco metálico para marcos  Металлические рамные дюбели 	199
	 Concrete screws	<ul style="list-style-type: none">  Vis à béton  Betonschrauben  Tornillos para hormigón  Шурупы по бетону 	200
	 Nylon anchors with nail screw	<ul style="list-style-type: none">  Cheville en nylon avec clou  Nylandübel mit Nagelschraube  Tacos de nylon con tornillo clavable  Нейлоновые дюбель-звезды 	202
	 Nylon anchors with wood screw	<ul style="list-style-type: none">  Cheville en nylon avec vis à bois  Nylandübel mit Holzschraube  Tacos de nylon con tornillo para madera  Нейлоновые дюбели с шурупом 	205
	 Pan head BIMETAL self drilling screw	<ul style="list-style-type: none">  Vis autoperceuse bi-métal tête cylindrique  Bimetall Zylinderkopf- Bohrschraube  Tornillo autotaladrante BIMETAL, cabeza cilíndrica  Самосверлящий шуруп с цилиндрической головкой 	211
	 Four fingers clamp	<ul style="list-style-type: none">  Équerre à quatre pinces  Klammer mit vier Klemmen  Clip cincada con cuatro agujeros  Оцинкованный крепежный кляммер рядовой 	212
	 Through-holed set screw and rivet nut	<ul style="list-style-type: none">  Bouchon à six pans creux  Gewindestift mit Innensechskant  Tornillo hueco sin cabeza con huella hexagonal  Винт установочный, внутренний шестигранник 	214
	 Self drilling screws	<ul style="list-style-type: none">  Vis autoperceuse  Bohrschrauben  Tornillos autotaladrantes  Самосверлящий шуруп 	216
	 Tapping screws	<ul style="list-style-type: none">  Vis autotaraudeuse  Blechschraube  Tornillo autorroscante  Шуруп-саморез 	224
	 Pan washer head tapping screw	<ul style="list-style-type: none">  Vis autotaraudeuse tête cylindrique  Tellerkopf - Blechschraube  Tornillo autorroscante con cabeza cilíndrica arandela estampada  Шуруп-саморез с полукруглой головкой 	230
	 Pan washer head screw for plastic	<ul style="list-style-type: none">  Vis tête cylindrique pour plastique  Tellerkopfschraube für Plastik  Tornillo para plástico con cabeza cilíndrica arandela estampada  Шуруп для пластика 	230
	 Cylinder head hex recess machine screw	<ul style="list-style-type: none">  Vis tête cylindrique à six pans creux  Zylinderkopfschraube mit Innensechskant  Tornillo rosca métrica con cabeza cilíndrica huella hexagonal  Винт с цилиндрической головкой 	231
	 Cylinder head hex self tapping screw	<ul style="list-style-type: none">  Vis autotaraudeuse, tête cylindrique à six pans creux  Zylinderkopf- Blechschraube mit Innensechskant  Tornillo autorroscante con cabeza cilíndrica huella hexagonal  Шуруп-саморез с цилиндрической головкой 	231
	 Screws and anchors with door-stop	<ul style="list-style-type: none">  Chevilles et vis avec butoir de porte  Dübeln und Schrauben mit Türstopper  Tacos y tornillos con tope de puertas  Дюбели и шурупы с ограничителем открывания 	232
	 Door-stop	<ul style="list-style-type: none">  Butoir de porte  Türstopper  Tope de puertas  Ограничитель открывания 	234
	 Stop & Go - Magnetic door stop	<ul style="list-style-type: none">  Stop&Go - Ferme-porte magnétique  Stop&Go - Magnetischer Türschließer  Stop&Go - Tope de puertas magnético  Stop & Go - магнитный ограничитель открывания двери 	234

Windows and frames fixing systems

 Systèmes pour fixation légères de bâtis

 Systeme für die Befestigung von Fenster- und Türenrahmen

 Sistemas para fijaciones de Ventanas y Marcos

 Рамные и дверные крепления

VS Handyplug®

THE FACTOTUM PLUG

THE MULTI-PURPOSE NYLON ANCHOR ETA-CE CERTIFIED

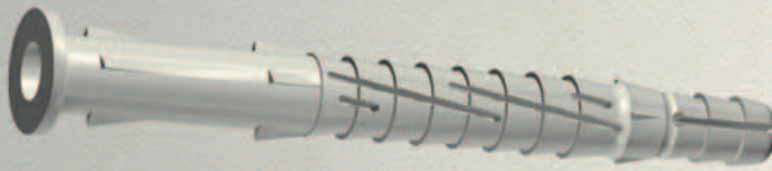

PATENTED DESIGN

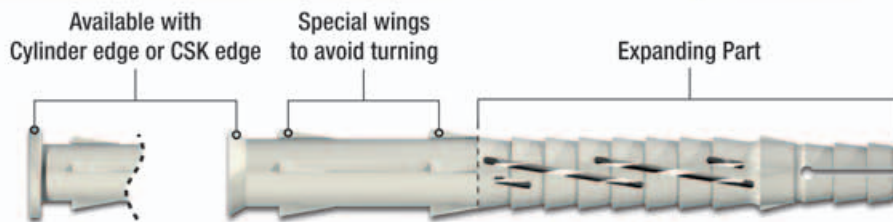

Zinc Plated



Stainless Steel **INOX WAVE**
A4-70 (AISI 316)



Special Finishing



1000 hours SST



Latest 2018: also available with "Steel Saver 1000h - ZL" special coating, guarantees a very high Salt Spray Test corrosion resistance, up to 20 times higher than standard zinc plating coatings.

Concrete, Solid Masonry

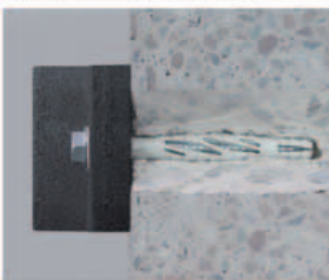

Full radial expansion behaviour on concrete and solid masonry

Perforated Masonry



Multiple radial expansion behaviour on perforated masonry

Hollow Masonry

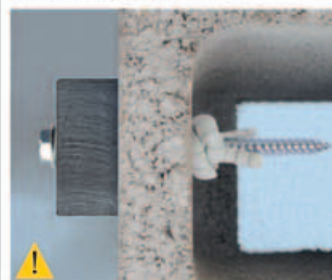

Knotted behaviour on hollow masonry (not covered by ETA)

Aerated autoclaved concrete



Full radial expansion behaviour on aerated autoclaved concrete

Made in Italy



Ideal for façades and frames

VS-Handyplug® multi-purpose high performance nylon anchor for fixing on almost all base materials, has achieved in the 2017 an updated **European Technical Assessment** according to the "Guideline ETAG020", with more and new base materials (**Use category: a, b, c, d**), and with **fire resistance R90 (for the diameter 10)**.

VS-Handyplug® includes a very wide screws range, combining the great mechanical performance with very high corrosion resistance.

- a - Concrete**
Full radial expansion
- b - Solid masonry**
Full radial expansion
- c - Hollow or perforated masonry**
Multiple radial expansion
- d - Aerated autoclaved concrete**
Full radial expansion



European Technical Assessment
Use Category: a,b,c,d
ETA-13/0135 – ETAG 020



CrVI free
in compliance with
European Directive
RoHS 2 2011/65/UE



You
Tube



VS 11 - VS 13



- Multi-purpose countersunk edge nylon anchor, with 6-lobe recess flat countersunk head special wood screw, ETA-CE certified
- Cheville universelle rallongée en nylon à collerette fraisée, avec vis à bois spéciale tête fraisée avec empreinte à six lobes, avec certification ETE-CE
- Universal-Langschafthdübel aus Nylon mit Senkkopfkragen mit spezieller Innensechsrund Senkkopf-Holzschraube, ETA-CE zertifiziert
- Taco universal de nylon con collarín avellanado, con tornillo especial para madera con cabeza avellanada 6 lóbulos internos, Homologado ETA-CE
- Универсальный нейлоновый дюбель с плоским бортом, со специальным шурупом с плоской потайной головкой и шестигранным шлицем

VS 11 zinc plated screw / zinguée / verzinkt / tornillo cincado / оцинкованным

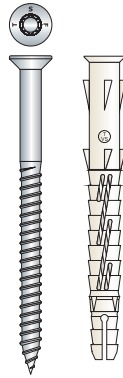

Item code	Anchor size Ø x L / t _{fix} (mm)	Screw size Øs x Ls (mm)	Pcs. per box	Pcs. per carton
Ø 8 / T-30				
VS 11 08 080	8 x 80 / 10	6 x 85	50	500
VS 11 08 100	8 x 100 / 30	6 x 105	50	500
VS 11 08 120	8 x 120 / 50	6 x 125	50	500
VS 11 08 140	8 x 140 / 70	6 x 145	50	500
Ø 10 / T-40				
VS 11 10 080	10 x 80 / 10	7 x 85	50	500
VS 11 10 100	10 x 100 / 30	7 x 105	50	500
VS 11 10 120	10 x 120 / 50	7 x 125	25	250
VS 11 10 140	10 x 140 / 70	7 x 145	25	250
VS 11 10 160	10 x 160 / 90	7 x 165	25	250
VS 11 10 200	10 x 200 / 130	7 x 205	25	250
VS 11 10 230	10 x 230 / 160	7 x 235	25	250

VS 13 A4-70 (AISI 316) stainless steel screw / vis en acier Inox A4-70 (AISI 316) / Edelstahlschraube A4-70 (AISI 316) / tornillo de acero Inoxidable A4-70 (AISI 316) / шурупом нержавеющей стали A4-70 (AISI 316)

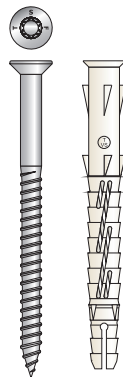

Item code	Anchor size Ø x L / t _{fix} (mm)	Screw size Øs x Ls (mm)	Pcs. per box	Pcs. per carton
Ø 8 / T-30				
VS 13 08 080	8 x 80 / 10	6 x 85	50	500
VS 13 08 100	8 x 100 / 30	6 x 105	50	500
VS 13 08 120	8 x 120 / 50	6 x 125	50	500
VS 13 08 140	8 x 140 / 70	6 x 145	25	250
Ø 10 / T-40				
VS 13 10 080	10 x 80 / 10	7 x 85	50	500
VS 13 10 100	10 x 100 / 30	7 x 105	50	500
VS 13 10 120	10 x 120 / 50	7 x 125	25	250
VS 13 10 140	10 x 140 / 70	7 x 145	25	250
VS 13 10 160	10 x 160 / 90	7 x 165	25	250
VS 13 10 200	10 x 200 / 130	7 x 205	25	250
VS 13 10 230	10 x 230 / 160	7 x 235	25	250



European Technical Assessment
ETAG 020
Use Category: a,b,c,d

- ETA-CE Certified item / ETE-CE Agrément technique européen / ETA-CE Zulassung / Homologación ETA-CE / Сертификация ETA-CE
- VS-Handyplug® Ø10: at least 90 minutes fire resistance (R90) for fastening of façade systems on concrete, if the admissible load ≤ 0,8 [kN] (no permanent centric tension load)
- VS-Handyplug® Ø10: Produit certifié pour la résistance au feu 90 minutes (R90) pour le montage de façade-rideau ventilée sur béton pour charges ≤ a 0,8[kN] (charges axiales permanentes pas admises)
- VS-Handyplug® Ø10: Produkt zugelassen für Feuerwiderstand 90 Min. (R90) für die Montage von Vorhangfassaden auf Beton für Lasten ≤ a 0,8[kN] (Ständige axiale Belastungen nicht erlaubt)
- VS-Handyplug® Ø10: Producto homologado para resistencia al fuego superior a 90 minutos de exposición (R90) para la instalación de fachadas continuas sobre hormigón para cargas ≤ a 0,8[kN] (cargas axiales permanentes no permitidas)
- VS-Handyplug® Ø10: Сертифицированные изделия для огнестойкости более 90 минут (R90) для установки навесных фасадов на бетон для нагрузок ≤ 0,8 [кН] (постоянные осевые нагрузки не допускаются)

Use Category

- a - normal weight concrete: by fully radial expansion
- b - solid masonry: (solid masonry, tuff, solid calcium silicate masonry) by fully radial expansion
- c - hollow or perforated masonry: (hollow masonry, Poroton, hollow calcium silicate masonry) by multiple radial expansion
- d - autoclaved aerated concrete: by fully radial expansion
- ▲ hollow masonries (not included in the ETA-CE): by knotting, thanks to the hard cone pulling

Usage / Utilisation / Benutzung / Uso / Применение

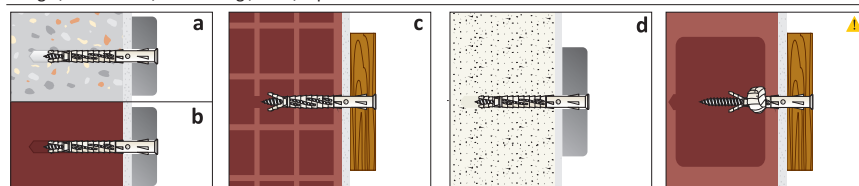

DoP



Box / Boîte / Verpackung Caja / Упаковка



VS 12 STEEL SAVER® Special Coating



🇬🇧 **Multi-purpose countersunk edge nylon anchor, with 6-lobe recess flat countersunk head special wood screw, special coating "Steel Saver® 1000h - ZL"**

🇫🇷 Cheville universelle rallongée en nylon à collerette fraisée, avec vis à bois tête fraisée plate finition spéciale "Steel Saver® 1000 h - ZL"

🇩🇪 Universal-Langschafthdübel aus Nylon mit Senkkopfkragen mit spezieller Innensechsrund Senkkopf-Holzschraube, spezielle Hochleistungsbehandlung "Steel Saver® 1000h - ZL"

🇪🇸 Taco universal de nylon con collarín avellanado, con tornillo especial para madera con cabeza avellanada 6 lóbulos internos, acabado especial "Steel Saver® 1000 h - ZL"

🇷🇺 Универсальный нейлоновый дюбель с плоским бортом, со специальным шурупом с плоской потайной головкой и шестигранным шлицем со специальным покрытием "Steel Saver®" 1000 часов в СТ

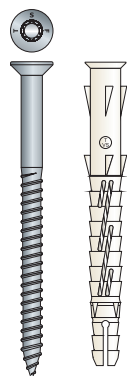

Item code	Anchor size Ø x L / t _{fix} (mm)	Screw size Øs x Ls (mm)	Pcs. per box	Pcs. per carton
Ø 8 / T-30				
in VS 12 08 080	8 x 80 / 10	6 x 85	50	500
in VS 12 08 100	8 x 100 / 30	6 x 105	50	500
VS 12 08 120	8 x 120 / 50	6 x 125	50	500
VS 12 08 140	8 x 140 / 70	6 x 145	50	500
Ø 10 / T-40				
in VS 12 10 080	10 x 80 / 10	7 x 85	50	500
in VS 12 10 100	10 x 100 / 30	7 x 105	50	500
in VS 12 10 120	10 x 120 / 50	7 x 125	25	250
VS 12 10 140	10 x 140 / 70	7 x 145	25	250
VS 12 10 160	10 x 160 / 90	7 x 165	25	250
VS 12 10 200	10 x 200 / 130	7 x 205	25	250
VS 12 10 230	10 x 230 / 160	7 x 235	25	250



"Steel Saver® 1000h - ZL" special coating



Tecfi "Steel Saver® 1000h - ZL" special coating guarantees a very high Salt Spray Test corrosion resistance, up to 10 times higher than standard zinc plating coatings.

Technical Data Sheet



Box / Boîte / Verpackung / Caja / Упаковка



Please see technical details on page 14

Usage / Utilisation / Benutzung / Uso / Применение

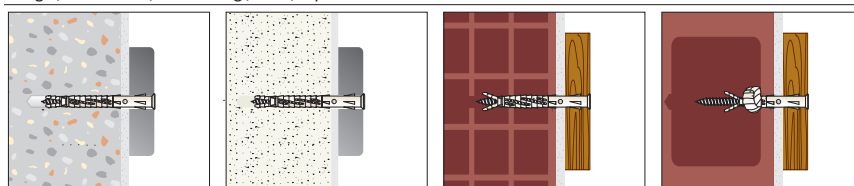

For fixing on all types of material:

- on concrete and solid masonry: by fully radial expansion
- on hollow masonry: by knotting (not included into ETA-CE)
- on perforated masonry: by multiple radial expansion
- on aerated autoclaved concrete: by fully radial expansion

VS 31 - VS 33



- 🇬🇧 **Multi-purpose countersunk edge nylon anchor, with 6-lobe recess hexagonal washer head special wood screw, ETA-CE certified**
- 🇫🇷 Cheville universelle rallongée en nylon à collerette fraisée, avec vis à bois spéciale tête hexagonale empreinte à six lobes, avec certification ETE-CE
- 🇩🇪 Universal-Langschafthdübel aus Nylon mit Senkkopfkragen mit spezieller Innensechsrund Sechskant-Holzschraube, ETA-CE zertifiziert
- 🇪🇸 Taco universal de nylon con collarín avellanado, con tornillo especial para madera con cabeza hexagonal arandela estampada 6 lóbulos internos, Homologado ETA-CE
- 🇷🇺 Универсальный нейлоновый дюбель с плоским бортом, со специальным шурупом с шестигранной головкой и шестигранным шлицем

VS 31 zinc plated screw / zinguée / verzinkt / tornillo cincado / оцинкованным

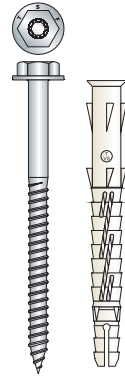

Item code	Anchor size Ø x L / t _{fix} (mm)	Screw size Øs x Ls (mm)	Pcs. per box	Pcs. per carton
Ø 8 / T-30 / SW: 10				
VS 31 08 080	8 x 80 / 10	6 x 85	50	500
VS 31 08 100	8 x 100 / 30	6 x 105	50	500
VS 31 08 120	8 x 120 / 50	6 x 125	50	500
VS 31 08 140	8 x 140 / 70	6 x 145	50	500
Ø 10 / T-40 / SW: 13				
VS 31 10 080	10 x 80 / 10	7 x 85	50	500
VS 31 10 100	10 x 100 / 30	7 x 105	50	500
VS 31 10 120	10 x 120 / 50	7 x 125	25	250
VS 31 10 140	10 x 140 / 70	7 x 145	25	250
VS 31 10 160	10 x 160 / 90	7 x 165	25	250
VS 31 10 200	10 x 200 / 130	7 x 205	25	250
VS 31 10 230	10 x 230 / 160	7 x 235	25	250

VS 33 A4-70 (AISI 316) stainless steel screw / vis en acier Inox A4-70 (AISI 316) / Edelstahlschraube A4-70 (AISI 316) / tornillo de acero Inoxidable A4-70 (AISI 316) / шурупом нержавеющей стали A4-70 (AISI 316)

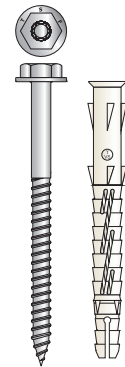

Item code	Anchor size Ø x L / t _{fix} (mm)	Screw size Øs x Ls (mm)	Pcs. per box	Pcs. per carton
Ø 8 / T-30 / SW: 10				
VS 33 08 080	8 x 80 / 10	6 x 85	50	500
VS 33 08 100	8 x 100 / 30	6 x 105	50	500
VS 33 08 120	8 x 120 / 50	6 x 125	50	500
VS 33 08 140	8 x 140 / 70	6 x 145	25	250
Ø 10 / T-40 / SW: 13				
VS 33 10 080	10 x 80 / 10	7 x 85	50	500
VS 33 10 100	10 x 100 / 30	7 x 105	50	500
VS 33 10 120	10 x 120 / 50	7 x 125	25	250
VS 33 10 140	10 x 140 / 70	7 x 145	25	250
VS 33 10 160	10 x 160 / 90	7 x 165	25	250
VS 33 10 200	10 x 200 / 130	7 x 205	25	250
VS 33 10 230	10 x 230 / 160	7 x 235	25	250



European Technical Assessment
ETAG 020
Use Category: a,b,c,d

ETA-CE Certified item / ETE-CE Agrément technique européen / ETA-CE Zulassung / Homologación ETA-CE / Сертификация ETA-CE
 VS-Handyplug® Ø10: at least 90 minutes fire resistance (R90) for fastening of façade systems on concrete, if the admissible load ≤ 0,8 [kN] (no permanent centric tension load)

VS-Handyplug® Ø10: Produit certifié pour la résistance au feu 90 minutes (R90) pour le montage de façade-rideau ventilée sur béton pour charges ≤ 0,8[kN] (charges axiales permanentes pas admises)

VS-Handyplug® Ø10: Produkt zugelassen für Feuerwiderstand 90 Min. (R90) für die Montage von Vorhangfassaden auf Beton für Lasten ≤ 0,8[kN] (Ständige axiale Belastungen nicht erlaubt)

VS-Handyplug® Ø10: Producto homologado para resistencia al fuego superior a 90 minutos de exposición (R90) para la instalación de fachadas continuas sobre hormigón para cargas ≤ 0,8[kN] (cargas axiales permanentes no permitidas)

VS-Handyplug® Ø10: Сертифицированные изделия для огнестойкости более 90 минут (R90) для установки навесных фасадов на бетон для нагрузок ≤ 0,8 [кН] (постоянные осевые нагрузки не допускаются)

Use Category

- a - normal weight concrete:** by fully radial expansion
- b - solid masonry:** (solid masonry, tuff, solid calcium silicate masonry) by fully radial expansion
- c - hollow or perforated masonry:** (hollow masonry, Poroton, hollow calcium silicate masonry) by multiple radial expansion
- d - autoclaved aerated concrete:** by fully radial expansion
- ⚠ **hollow masonries** (not included in the ETA-CE): by knotting, thanks to the hard cone pulling

Usage / Utilisation / Benutzung / Uso / Применение

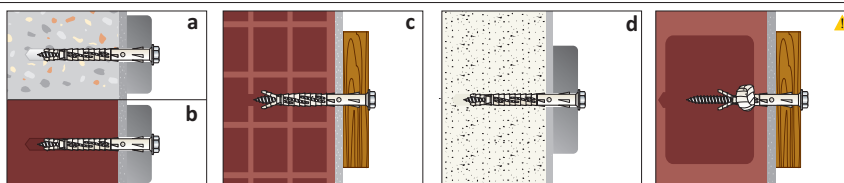

DoP



Box / Boîte / Verpackung
Caja / Упаковка



VS 32 STEEL SAVER® Special Coating



🇬🇧 **Multi-purpose countersunk edge nylon anchor, with 6-lobe recess hexagonal washer head special wood screw, special coating "Steel Saver® 1000h - ZL"**

- 🇫🇷 Cheville universelle rallongée en nylon à collerette fraisée, avec vis à bois tête hexagonale finition spéciale "Steel Saver® 1000 h - ZL"
- 🇩🇪 Universal-Langschafthdübel aus Nylon mit Senkkopfkragen und spezieller Innensechsrund Sechskant-Holzschraube mit spezieller Hochleistungsbehandlung "Steel Saver® 1000h - ZL"
- 🇪🇸 Taco universal de nylon con collarín avellanado, con tornillo especial para madera con cabeza hexagonal arandela estampada 6 lóbulos internos, acabado especial "Steel Saver® 1000 h - ZL"
- 🇷🇺 Универсальный нейлоновый дюбель с плоским бортом, со специальным шурупом с шестигранной головкой и шестигранным шлицем со специальным покрытием "Steel Saver®" 1000 часов в СТ

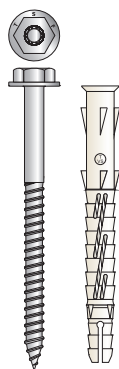

Item code	Anchor size Ø x L / t _{fix} (mm)	Screw size Øs x Ls (mm)	Pcs. per box	Pcs. per carton
Ø 8 / T-30 / SW: 10				
IA VS 32 08 080	8 x 80 / 10	6 x 85	50	500
IA VS 32 08 100	8 x 100 / 30	6 x 105	50	500
VS 32 08 120	8 x 120 / 50	6 x 125	50	500
VS 32 08 140	8 x 140 / 70	6 x 145	50	500
Ø 10 / T-40 / SW: 13				
IA VS 32 10 080	10 x 80 / 10	7 x 85	50	500
IA VS 32 10 100	10 x 100 / 30	7 x 105	50	500
IA VS 32 10 120	10 x 120 / 50	7 x 125	25	250
VS 32 10 140	10 x 140 / 70	7 x 145	25	250
VS 32 10 160	10 x 160 / 90	7 x 165	25	250
VS 32 10 200	10 x 200 / 130	7 x 205	25	250
VS 32 10 230	10 x 230 / 160	7 x 235	25	250



"Steel Saver® 1000h - ZL" special coating



Tecfi "Steel Saver® 1000h - ZL" special coating guarantees a very high Salt Spray Test corrosion resistance, up to 10 times higher than standard zinc plating coatings.

Technical Data Sheet



Box / Boîte / Verpackung / Caja / Упаковка



Please see technical details on page 14

Usage / Utilisation / Benutzung / Uso / Применение

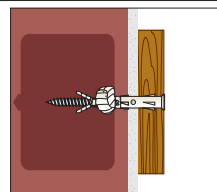
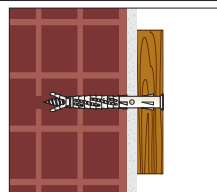
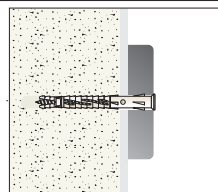
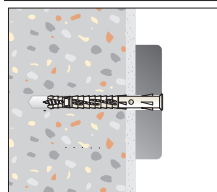

For fixing on all types of material:

- on concrete and solid masonry: by fully radial expansion
- on hollow masonry: by knotting (not included into ETA-CE)
- on perforated masonry: by multiple radial expansion
- on aerated autoclaved concrete: by fully radial expansion

VS 21



Multi-purpose countersunk edge nylon anchor, with zinc plated 6-lobe recess mushroom head special wood screw and small fitting cap, ETA-CE certified

- Cheville universelle rallongée en nylon à collerette fraisée, avec vis à bois spéciale tête bombée, empreinte à six lobes et cache-tête, avec certification ETE-CE**
- Universal-Langschafthdübel aus Nylon mit Senkkopfkragen mit spezieller Innensechsrund Rundkopf-Holzschraube und Einschalgstern, ETA-CE zertifiziert**
- Taco universal de nylon con collarín avellanado, con tornillo especial para madera con cabeza abombada 6 lóbulos internos y tapón para la inviolabilidad, Homologado ETA-CE**
- Универсальный нейлоновый дюбель с плоским бортом, со специальным шурупом с низкой полукруглой головкой с шестигранным шлицем и с заглушкой**

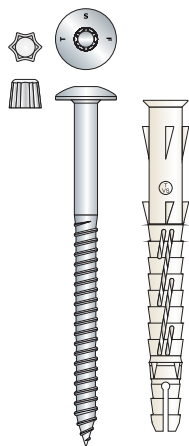

6-lobe



CrVI Free

On request, also available with "Steel Saver 1000h - ZL" special coating screw (over 1000 hours Salt Spray Test) (itemcode: VS 22)

Item code	Anchor size Ø x L / t _{fix} (mm)	Screw size Øs x Ls (mm)	Pcs. per box	Pcs. per carton
Ø 8 / T-30				
VS 21 08 080	8 x 80 / 10	6 x 85	50	500
VS 21 08 100	8 x 100 / 30	6 x 105	50	500
VS 21 08 120	8 x 120 / 50	6 x 125	50	500
VS 21 08 140	8 x 140 / 70	6 x 145	50	500
Ø 10 / T-40				
VS 21 10 080	10 x 80 / 10	7 x 85	50	500
VS 21 10 100	10 x 100 / 30	7 x 105	50	500
VS 21 10 120	10 x 120 / 50	7 x 125	25	250
VS 21 10 140	10 x 140 / 70	7 x 145	25	250
VS 21 10 160	10 x 160 / 90	7 x 165	25	250
VS 21 10 200	10 x 200 / 130	7 x 205	25	250

ETA-CE Certified item / ETE-CE Agrément technique européen / ETA-CE Zulassung / Homologación ETA-CE / Сертификация ETA-CE

VS-Handyplug® Ø10: at least 90 minutes fire resistance (R90) for fastening of façade systems on concrete, if the admissible load ≤ 0,8 [kN] (no permanent centric tension load)

VS-Handyplug® Ø10: Produit certifié pour la résistance au feu 90 minutes (R90) pour le montage de façade-rideau ventilée sur béton pour charges ≤ a 0,8[kN] (charges axiales permanentes pas admis)

VS-Handyplug® Ø10: Produkt zugelassen für Feuerwiderstand 90 Min. (R90) für die Montage von Vorhangfassaden auf Beton für Lasten ≤ a 0,8[kN] (Ständige axiale Belastungen nicht erlaubt)

VS-Handyplug® Ø10: Producto homologado para resistencia al fuego superior a 90 minutos de exposición (R90) para la instalación de fachadas continuas sobre hormigón para cargas ≤ a 0,8[kN] (cargas axiales permanentes no permitidas)

VS-Handyplug® Ø10: Сертифицированные изделия для огнестойкости более 90 минут (R90) для установки навесных фасадов на бетон для нагрузок ≤ 0,8 [кН] (постоянные осевые нагрузки не допускаются)



European Technical Assessment

ETAG 020

Use Category: a,b,c,d

Use Category

- a - normal weight concrete:** by fully radial expansion
- b - solid masonry:** (solid masonry, tuff, solid calcium silicate masonry) by fully radial expansion
- c - hollow or perforated masonry:** (hollow masonry, Poroton, hollow calcium silicate masonry) by multiple radial expansion
- d - autoclaved aerated concrete:** by fully radial expansion
- ▲ hollow masonries** (not included in the ETA-CE): by knotting, thanks to the hard cone pulling

Usage / Utilisation / Benutzung / Uso / Применение

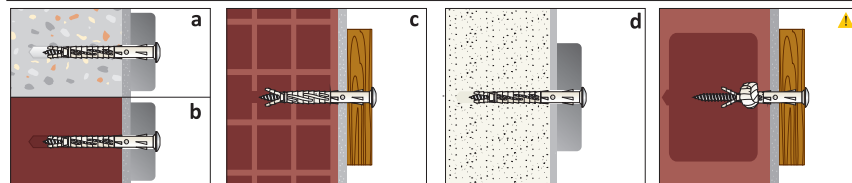

DoP



Box / Boîte / Verpackung
Caja / Упаковка



VS 71



🇬🇧 **Multi-purpose cylinder edge nylon anchor, with zinc plated 6-lobe recess mushroom head special wood screw and small fitting cap, ETA-CE certified**

- 🇫🇷 Cheville universelle rallongée en nylon à collerette cylindrique avec vis à bois spéciale tête bombée, empreinte à six lobes et cache-tête, avec certification ETE-CE
- 🇩🇪 Universal-Langschaftdübel aus Nylon mit zylindrischem Kragen mit spezieller Innensechsrund Rundkopf-Holzschraube und Einschalgstern, ETA-CE zertifiziert
- 🇪🇸 Taco universal de nylon con collarín cilíndrico, con tornillo especial para madera con cabeza abombada 6 lóbulos internos y tapón para, Homologado ETA-CE
- 🇷🇺 Универсальный нейлоновый дюбель с цилиндрическим бортом, со специальным шурупом с низкой полукруглой головкой с шестигранным шлицем и с заглушкой

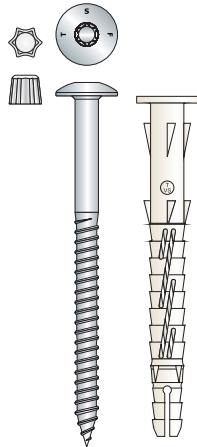

📌 On request, also available with "Steel Saver 1000h - ZL" special coating screw (over 1000 hours Salt Spray Test) (itemcode: VS 72)

Item code	Anchor size Ø x L / t _{fix} (mm)	Screw size Øs x Ls (mm)	Pcs. per box	Pcs. per carton
Ø 8 / T-30				
🌟 VS 71 08 080	8 x 80 / 10	6 x 85	50	500
🌟 VS 71 08 100	8 x 100 / 30	6 x 105	50	500
🌟 VS 71 08 120	8 x 120 / 50	6 x 125	50	500
🌟 VS 71 08 140	8 x 140 / 70	6 x 145	50	500
Ø 10 / T-40				
🌟🔥 VS 71 10 080	10 x 80 / 10	7 x 85	50	500
🌟🔥 VS 71 10 100	10 x 100 / 30	7 x 105	50	500
🌟🔥 VS 71 10 120	10 x 120 / 50	7 x 125	25	250
🌟🔥 VS 71 10 140	10 x 140 / 70	7 x 145	25	250
🌟🔥 VS 71 10 160	10 x 160 / 90	7 x 165	25	250
🌟🔥 VS 71 10 200	10 x 200 / 130	7 x 205	25	250

🌟🔥 **ETA-CE Certified item / ETE-CE Agrément technique européen / ETA-CE Zulassung / Homologación ETA-CE / Сертификация ETA-CE**
 🔥 **VS-Handyplug® Ø10: at least 90 minutes fire resistance (R90) for fastening of façade systems on concrete, if the admissible load ≤ 0,8 [kN] (no permanent centric tension load)**

VS-Handyplug® Ø10: Produit certifié pour la résistance au feu 90 minutes (R90) pour le montage de façade-rideau ventilée sur béton pour charges ≤ a 0,8[kN] (charges axiales permanentes pas admises)

VS-Handyplug® Ø10: Produkt zugelassen für Feuerwiderstand 90 Min. (R90) für die Montage von Vorhangfassaden auf Beton für Lasten ≤ a 0,8[kN] (Ständige axiale Belastungen nicht erlaubt)

VS-Handyplug® Ø10: Producto homologado para resistencia al fuego superior a 90 minutos de exposición (R90) para la instalación de fachadas continuas sobre hormigón para cargas ≤ a 0,8[kN] (cargas axiales permanentes no permitidas)

VS-Handyplug® Ø10: Сертифицированные изделия для огнестойкости более 90 минут (R90) для установки навесных фасадов на бетон для нагрузок ≤ 0,8 [кН] (постоянные осевые нагрузки не допускаются)



European Technical Assessment

ETAG 020

Use Category: a,b,c,d

Use Category

- a - normal weight concrete:** by fully radial expansion
- b - solid masonry:** (solid masonry, tuff, solid calcium silicate masonry) by fully radial expansion
- c - hollow or perforated masonry:** (hollow masonry, Poroton, hollow calcium silicate masonry) by multiple radial expansion
- d - autoclaved aerated concrete:** by fully radial expansion
- ⚠️ **hollow masonries** (not included in the ETA-CE): by knotting, thanks to the hard cone pulling

Usage / Utilisation / Benutzung / Uso / Применение

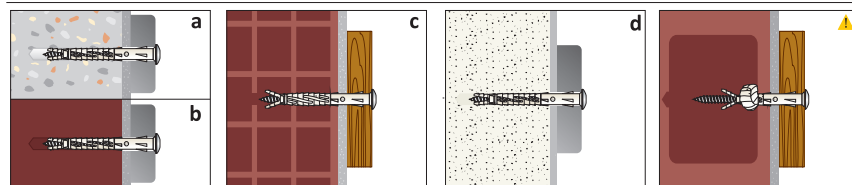

DoP



Box / Boîte / Verpackung
Caja / Упаковка



VS 81- VS 83



Multi-purpose cylinder edge nylon anchor, with 6-lobe recess hexagonal washer head special wood screw, ETA-CE certified

- Cheville universelle rallongée en nylon à collerette cylindrique, avec vis à bois spéciale tête hexagonale empreinte à six lobes, avec certification ETE-CE
- Universal-Langschaftdübel aus Nylon mit zylindrischem Kragen mit spezieller Innensechsrund Sechskant-Holzschraube, ETA-CE zertifiziert
- Taco universal de nylon con collarín cilíndrico, con tornillo especial para madera con cabeza hexagonal arandela estampada 6 lóbulos internos, Homologado ETA-CE
- Универсальный нейлоновый дюбель с цилиндрическим бортом, со специальным шурупом с шестигранной головкой и шестигранным шлицем

VS 81 zinc plated screw / zinguée / verzinkt / tornillo cincado / оцинкованным

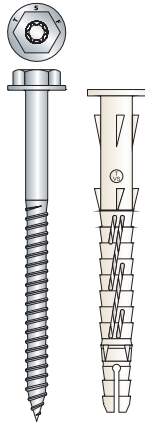

Item code	Anchor size $\varnothing \times L / t_{fix}$ (mm)	Screw size $\varnothing s \times L_s$ (mm)	Pcs. per box	Pcs. per carton
$\varnothing 8$ / T-30 / SW: 10				
VS 81 08 080	8 x 80 / 10	6 x 85	50	500
VS 81 08 100	8 x 100 / 30	6 x 105	50	500
VS 81 08 120	8 x 120 / 50	6 x 125	50	500
VS 81 08 140	8 x 140 / 70	6 x 145	50	500
$\varnothing 10$ / T-40 / SW: 13				
VS 81 10 080	10 x 80 / 10	7 x 85	50	500
VS 81 10 100	10 x 100 / 30	7 x 105	50	500
VS 81 10 120	10 x 120 / 50	7 x 125	25	250
VS 81 10 140	10 x 140 / 70	7 x 145	25	250
VS 81 10 160	10 x 160 / 90	7 x 165	25	250
VS 81 10 200	10 x 200 / 130	7 x 205	25	250
VS 81 10 230	10 x 230 / 160	7 x 235	25	250

VS 83 A4-70 (AISI 316) stainless steel screw / vis en acier Inox A4-70 (AISI 316) / Edelstahlschraube A4-70 (AISI 316) / tornillo de acero Inoxidable A4-70 (AISI 316) / шурупом нержавеющей стали A4-70 (AISI 316)

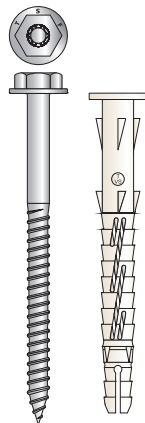

Item code	Anchor size $\varnothing \times L / t_{fix}$ (mm)	Screw size $\varnothing s \times L_s$ (mm)	Pcs. per box	Pcs. per carton
$\varnothing 8$ / T-30 / SW: 10				
VS 83 08 080	8 x 80 / 10	6 x 85	50	500
VS 83 08 100	8 x 100 / 30	6 x 105	50	500
VS 83 08 120	8 x 120 / 50	6 x 125	50	500
VS 83 08 140	8 x 140 / 70	6 x 145	25	250
$\varnothing 10$ / T-40 / SW: 13				
VS 83 10 080	10 x 80 / 10	7 x 85	50	500
VS 83 10 100	10 x 100 / 30	7 x 105	50	500
VS 83 10 120	10 x 120 / 50	7 x 125	25	250
VS 83 10 140	10 x 140 / 70	7 x 145	25	250
VS 83 10 160	10 x 160 / 90	7 x 165	25	250
VS 83 10 200	10 x 200 / 130	7 x 205	25	250
VS 83 10 230	10 x 230 / 160	7 x 235	25	250



European Technical Assessment

ETAG 020

Use Category: a,b,c,d

- ETA-CE Certified item / ETE-CE Agrément technique européen / ETA-CE Zulassung / Homologación ETA-CE / Сертификация ETA-CE
- VS-Handyplug® $\varnothing 10$: at least 90 minutes fire resistance (R90) for fastening of façade systems on concrete, if the admissible load $\leq 0,8$ [kN] (no permanent centric tension load)
- VS-Handyplug® $\varnothing 10$: Produit certifié pour la résistance au feu 90 minutes (R90) pour le montage de façade-rideau ventilée sur béton pour charges $\leq 0,8$ [kN] (charges axiales permanentes pas admises)
- VS-Handyplug® $\varnothing 10$: Produkt zugelassen für Feuerwiderstand 90 Min. (R90) für die Montage von Vorhangfassaden auf Beton für Lasten $\leq 0,8$ [kN] (Ständige axiale Belastungen nicht erlaubt)
- VS-Handyplug® $\varnothing 10$: Producto homologado para resistencia al fuego superior a 90 minutos de exposición (R90) para la instalación de fachadas continuas sobre hormigón para cargas $\leq 0,8$ [kN] (cargas axiales permanentes no permitidas)
- VS-Handyplug® $\varnothing 10$: Сертифицированные изделия для огнестойкости более 90 минут (R90) для установки навесных фасадов на бетон для нагрузок $\leq 0,8$ [кН] (постоянные осевые нагрузки не допускаются)

Use Category

- a - normal weight concrete:** by fully radial expansion
- b - solid masonry:** (solid masonry, tuff, solid calcium silicate masonry) by fully radial expansion
- c - hollow or perforated masonry:** (hollow masonry, Poroton, hollow calcium silicate masonry) by multiple radial expansion
- d - autoclaved aerated concrete:** by fully radial expansion
- ▲ hollow masonries** (not included in the ETA-CE): by knotting, thanks to the hard cone pulling

Usage / Utilisation / Benutzung / Uso / Применение

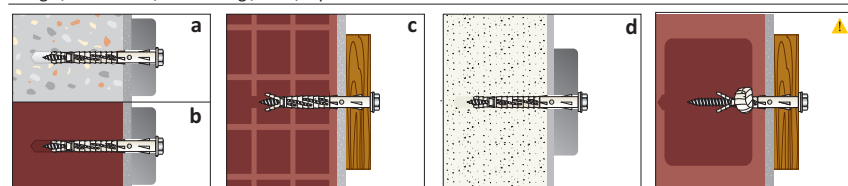

DoP



Box / Boîte / Verpackung
Caja / Упаковка

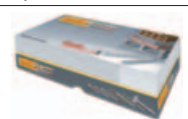

VS 82 STEEL SAVER® Special Coating



🇬🇧 **Multi-purpose cylinder edge nylon anchor, with 6-lobe recess hexagonal washer head special wood screw, "Steel Saver® 1000h - ZL"**

🇫🇷 Cheville universelle rallongée en nylon à collerette cylindrique, avec vis à bois spéciale tête hexagonale empreinte à six lobes, finition spéciale "Steel Saver® 1000 h - ZL"

🇩🇪 Universal-Langschaftdübel aus Nylon mit zylindrischem Kragen und spezieller Innensechsrund Sechskant-Holzschraube mit spezieller Hochleistungsbehandlung "Steel Saver® 1000h - ZL"

🇪🇸 Taco universal de nylon con collarín cilíndrico, con tornillo especial para madera con cabeza hexagonal arandela estampada 6 lóbulos internos, acabado especial "Steel Saver® 1000 h - ZL"

🇷🇺 Универсальный нейлоновый дюбель с цилиндрическим бортом, со специальным шурупом с шестигранной головкой и шестигранным шлицем со специальным покрытием "Steel Saver®" 1000 часов в СТ

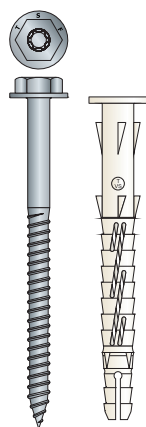
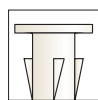

Item code	Anchor size Ø x L / t _{fix} (mm)	Screw size Øs x Ls (mm)	Pcs. per box	Pcs. per carton
Ø 8 / T-30 / SW: 10				
VS 82 08 080	8 x 80 / 10	6 x 85	50	500
VS 82 08 100	8 x 100 / 30	6 x 105	50	500
VS 82 08 120	8 x 120 / 50	6 x 125	50	500
VS 82 08 140	8 x 140 / 70	6 x 145	50	500
Ø 10 / T-40 / SW: 13				
VS 82 10 080	10 x 80 / 10	7 x 85	50	500
VS 82 10 100	10 x 100 / 30	7 x 105	50	500
VS 82 10 120	10 x 120 / 50	7 x 125	25	250
VS 82 10 140	10 x 140 / 70	7 x 145	25	250
VS 82 10 160	10 x 160 / 90	7 x 165	25	250
VS 82 10 200	10 x 200 / 130	7 x 205	25	250
VS 82 10 230	10 x 230 / 160	7 x 235	25	250



6 lobe



Across flats



STEEL SAVER
1.000h



CrVI free

"Steel Saver® 1000h - ZL" special coating



Tecfi "Steel Saver® 1000h - ZL" special coating guarantees a very high Salt Spray Test corrosion resistance, up to 10 times higher than standard zinc plating coatings.

Technical
Data Sheet



Box / Boîte / Verpackung / Caja / Упаковка



Please see technical details on page 14

Usage / Utilisation / Benutzung / Uso / Применение

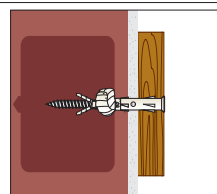
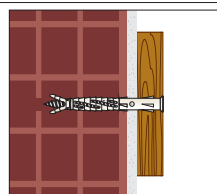
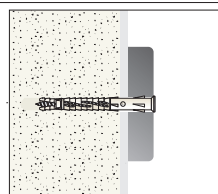
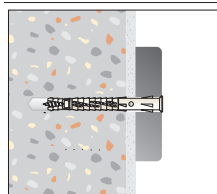

For fixing on all types of material:

- on concrete and solid masonry: by fully radial expansion
- on hollow masonry: by knotting (not included into ETA-CE)
- on perforated masonry: by multiple radial expansion
- on aerated autoclaved concrete: by fully radial expansion

- Multi-purpose nylon anchor, with socket recess dual thread (machine + special)**
- Cheville universelle rallongée en nylon, avec vis double filet (métrique et spécial)
- Universal-Langschafthdübel aus Nylon, Innensechskantschraube mit Doppelgewinde (metrisches und spezielles)
- Taco universal de nylon, con tornillo doble rosca (métrica + especial) con huella hexagonal
- Универсальный нейлоновый дюбель с плоским бортом, двухсторонним с внутренним шестигранником

VS 41 zinc plated screw / zinguée / verzinkt / tornillo cincado / оцинкованным

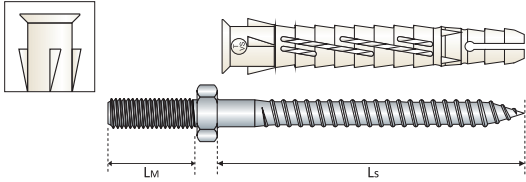

Item code	Anchor size $\varnothing \times L / t_{fix} (mm)$	Dual thread screw $\varnothing s \times Ls / M \times Lm (mm)$	Pcs. per box	Pcs. per carton
$\varnothing 8 / SW: 10 / In-hex (s): 3$				
* VS 41 08 080	8 x 80 / 10	$\varnothing 6 \times 85 / M6 \times 21$	100	1.000
$\varnothing 10 / SW: 13 / In-hex (s): 4$				
* VS 41 10 080	10 x 80 / 10	$\varnothing 7 \times 85 / M8 \times 25$	50	500
$\varnothing 10 / SW: 13 / without In-hex$				
VS 41 10 160	10 x 160 / 90	$\varnothing 7 \times 165 / M8 \times 20$	25	250
VS 41 10 200	10 x 200 / 130	$\varnothing 7 \times 205 / M8 \times 20$	25	250

* with hex recess until stockout, then WITHOUT hex recess / à six pans creux jusqu'à épuisement de stock, après sans six pans creux / Mit Sechskant-Einbuchtung bis Lagerende, nach Lagerende ohne Sechskant-Einbuchtung / con huella hexagonal hasta agotar existencias. Luego se entregará el producto sin huella / с внутренним шестигранником до конца стока, потом без внутреннего шестигр.

VS 43 A4-70 (AISI 316) stainless steel screw / vis en acier Inox A4-70 (AISI 316) / Edelstahlschraube A4-70 (AISI 316) / tornillo de acero Inoxidable A4-70 (AISI 316) / шурупом нержавеющей стали A4-70 (AISI 316)

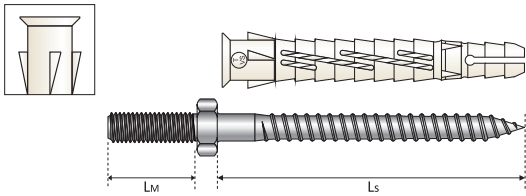

Item code	Anchor size $\varnothing \times L / t_{fix} (mm)$	Dual thread screw $\varnothing s \times Ls / M \times Lm (mm)$	Pcs. per box	Pcs. per carton
$\varnothing 8 / SW: 10 / In-hex (s): 3$				
VS 43 08 080	8 x 80 / 10	$\varnothing 6 \times 85 / M6 \times 21$	100	1.000
$\varnothing 10 / SW: 13 / In-hex (s): 4$				
VS 43 10 080	10 x 80 / 10	$\varnothing 7 \times 85 / M8 \times 25$	50	500

VS 91 zinc plated screw / zinguée / verzinkt / tornillo cincado / оцинкованным

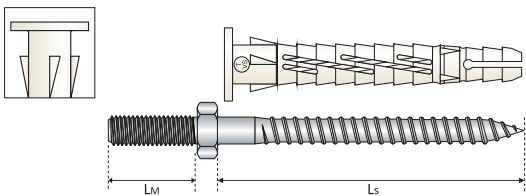

Item code	Anchor size $\varnothing \times L / t_{fix} (mm)$	Dual thread screw $\varnothing s \times Ls / M \times Lm (mm)$	Pcs. per box	Pcs. per carton
$\varnothing 8 / SW: 10 / In-hex (s): 3$				
* VS 91 08 080	8 x 80 / 10	$\varnothing 6 \times 85 / M6 \times 21$	100	1.000
$\varnothing 10 / SW: 13 / In-hex (s): 4$				
* VS 91 10 080	10 x 80 / 10	$\varnothing 7 \times 85 / M8 \times 25$	50	500
$\varnothing 10 / SW: 13 / without In-hex$				
VS 91 10 160	10 x 160 / 90	$\varnothing 7 \times 165 / M8 \times 20$	25	250
VS 91 10 200	10 x 200 / 130	$\varnothing 7 \times 205 / M8 \times 20$	25	250

* with hex recess until stockout, then WITHOUT hex recess / à six pans creux jusqu'à épuisement de stock, après sans six pans creux / Mit Sechskant-Einbuchtung bis Lagerende, nach Lagerende ohne Sechskant-Einbuchtung / con huella hexagonal hasta agotar existencias. Luego se entregará el producto sin huella / с внутренним шестигранником до конца стока, потом без внутреннего шестигр.

VS 93 A4-70 (AISI 316) stainless steel screw / vis en acier Inox A4-70 (AISI 316) / Edelstahlschraube A4-70 (AISI 316) / tornillo de acero Inoxidable A4-70 (AISI 316) / шурупом нержавеющей стали A4-70 (AISI 316)

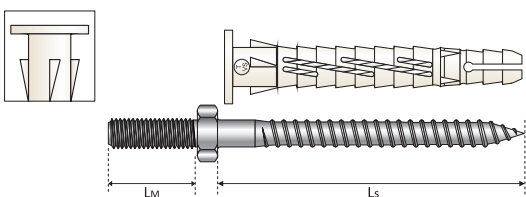

Item code	Anchor size $\varnothing \times L / t_{fix} (mm)$	Dual thread screw $\varnothing s \times Ls / M \times Lm (mm)$	Pcs. per box	Pcs. per carton
$\varnothing 8 / SW: 10 / In-hex (s): 3$				
VS 93 08 080	8 x 80 / 10	$\varnothing 6 \times 85 / M6 \times 21$	100	1.000
$\varnothing 10 / SW: 13 / In-hex (s): 4$				
VS 93 10 080	10 x 80 / 10	$\varnothing 7 \times 85 / M8 \times 25$	50	500

VS Handyplug®

— THE FACTOTUM PLUG —

MULTI-PURPOSE NYLON ANCHOR WITH DUAL THREAD SCREW

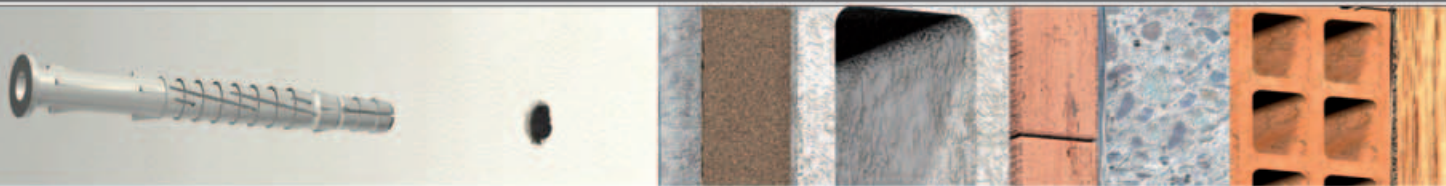

For fix on all base materials

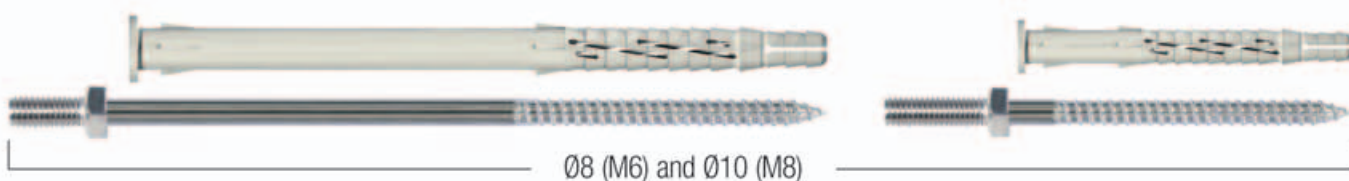

Also available in the **EXTRA-LONG** version for fixing **through insulation layers**

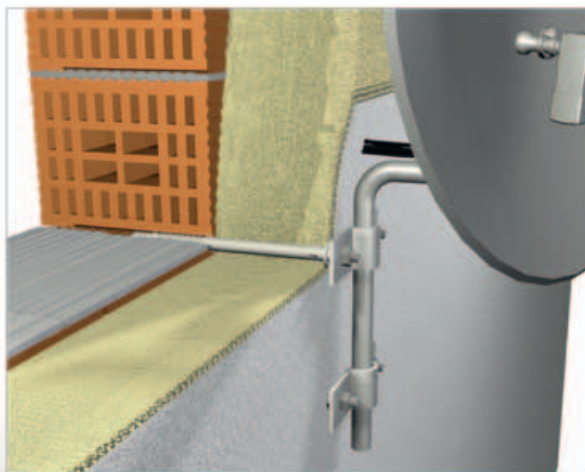
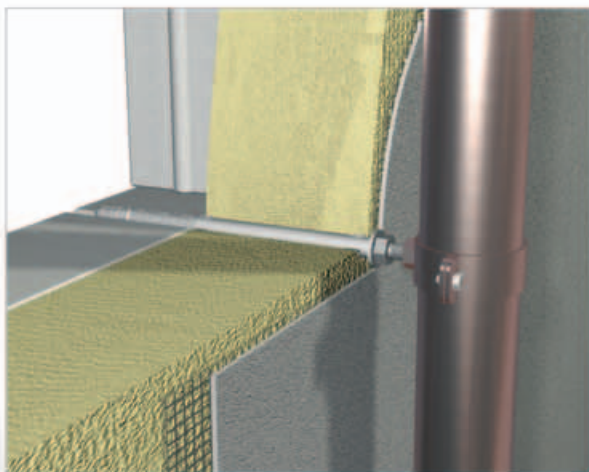
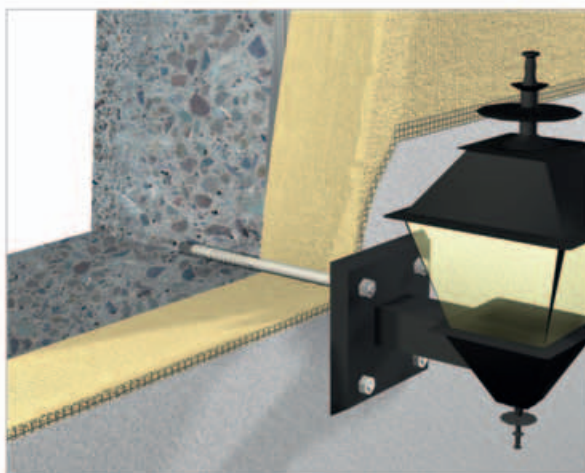
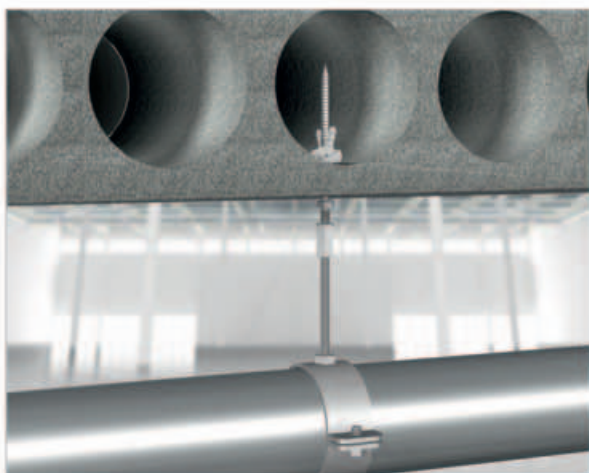

AT 01

 **Nylon frame anchor assembled with zinc plated flat countersunk head wood screw, and plastic white cap**

 Cheville cadre en nylon rallongée assemblée avec vis à bois tête fraisée plate zinguée et cache-tête blanc en plastique

 Langschaftdübel aus Nylon für Fensterrahmen mit verzinkter Senkkopf-Holzschraube montiert und weißer Plastikkappe

 Taco de nylon para marcos, montado con tornillo para madera con cabeza avellanada de acero cincado y tapón blanco de plástico

 Нейлоновый рамный дюбель в комплекте с оцинкованным шурупом с плоской потайной головкой и с белой пластиковой заглушкой



Item code	Anchor size Ø x L (mm)	Screw size Øs x Ls (mm)	Pcs. per box	Pcs. per carton
Ø 8 / Pz 3				
AT 01 08 075	8 x 75	5 x 85	100	1.000
AT 01 08 100	8 x 100	5 x 110	100	1.000
AT 01 08 120	8 x 120	5 x 130	100	500
AT 01 08 140	8 x 140	5 x 150	100	500
Ø 10 / Pz 3				
AT 01 10 075	10 x 75	6 x 85	100	500
AT 01 10 100	10 x 100	6 x 110	100	500
AT 01 10 120	10 x 120	6 x 130	100	500
AT 01 10 140	10 x 140	6 x 150	50	250
AT 01 10 165	10 x 165	6 x 175	50	250

Technical
Data Sheet



Installation sequence / Instructions de mise en oeuvre / Setzanweisung / Secuencia de instalación / Порядок монтажа

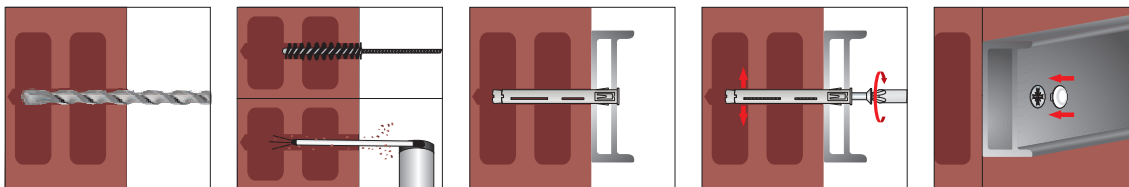

Box / Boîte / Verpackung
Caja / Упаковка

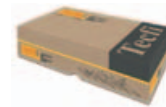

FR

Pre-galvanized metal frame anchor with nut with cross type Z recess flat countersunk head screw (pan head diam. 8), and plastic white cap

- Cheville cadre à douille zinguée avec écrou accroché et vis tête fraisée plate empreinte Z (tête cylindrique diam. 8mm.) et cache-tête blanc en plastique
- Hülsenanker aus Metall mit fester Schraubenmutter, verzinkter Senkkopfschraube Kreuzschlitz Z (Linsenkopf Durchmesser 8mm.) und weißer Plastikkappe
- Anclaje metálico pregalvanizado para marcos, con cono y montado con tornillo cabeza avellanada cruz tipo Z (cabeza cilíndrica diám. 8), con tapón blanco de plástico
- Оцинкованный металлический дюбель с конической гайкой, с шурупом с плоской потайной головкой с крестообразным шлицем типа Z и белой пластиковой заглушкой



Cross Type Z



FR 01 - Ø 8
Pan Head

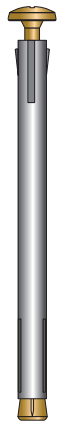

FR 01 - Ø 10
Flat CSK head

Item code	Anchor size Ø x L (mm)	Screw size Øs x Ls (mm)	Pcs. per box	Pcs. per carton
Ø 8 / Pz 2				
▲ FR 01 08 072	8 x 72	M5 x 85	100	1.000
▲ FR 01 08 092	8 x 92	M5 x 105	100	1.000
Ø 10 / Pz 3				
FR 01 10 072	10 x 72	M6 x 88	100	500
FR 01 10 092	10 x 92	M6 x 108	100	500
FR 01 10 112	10 x 112	M6 x 128	100	500
FR 01 10 132	10 x 132	M6 x 148	100	500
FR 01 10 152	10 x 152	M6 x 168	50	250
FR 01 10 182	10 x 182	M6 x 195	50	250

▲ It will become FR 02 / Il deviendra FR 02 / Es wird FR 02 / se cambiarán en FR 02 / Будет заменен артикулом FRO2

Technical
Data Sheet



FR 02 with PAN washer head / avec vis tête cylindrique à rondelle intégrée / mit Linsenkopfschraube mit Unterlegscheibe / con cabeza cilíndrica y arandela estampada / с полукруглой головкой с пресс-шайбой



Cross Type Z

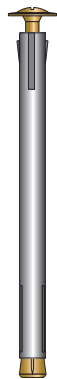

FR 02 - Ø 8
Pan Washer Head

Item code	Anchor size Ø x L (mm)	Screw size Øs x Ls (mm)	Pcs. per box	Pcs. per carton
Ø 8 / Pz 2				
FR 02 08 072	8 x 72	M5 x 85	100	1.000
FR 02 08 092	8 x 92	M5 x 105	100	1.000
FR 02 08 112	8 x 112	M5 x 125	100	500
FR 02 08 132	8 x 132	M5 x 145	100	500

Technical
Data Sheet



Installation sequence / Instructions de mise en oeuvre / Setzanweisung / Secuencia de instalación / Порядок монтажа

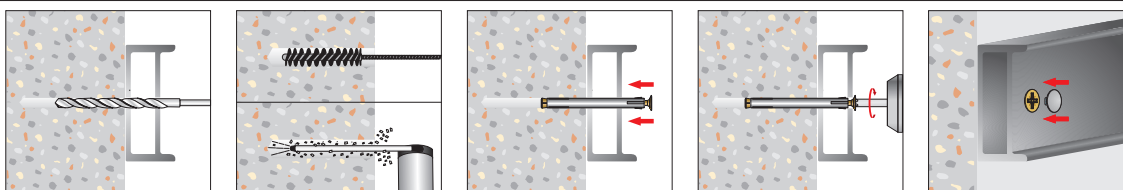

Box / Boîte / Verpackung
Caja / Упаковка

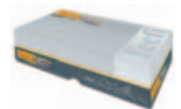

GS 01

6-lobe recess flat countersunk head concrete screw (Hi-Lo thread) with ribs, hardened, zinc plated

- Vis à béton (filet Hi-Lo) tête fraisée plate à six lobes X avec nervures, cémentée et zinguée
- Senkkopf- Betonschraube (Hi-Lo Gewinde) mit Innensechsrund und Fräsrippen, einsetzgehärtet, verzinkt
- Tornillo para hormigón (rosca Hi-Lo), cabeza avellanada 6 lóbulos internos con estrías bloqueadoras, acero cementado, cincado
- Шуруп по бетону из закаленной стали (резьба Hi-Lo) с плоской потайной головкой, шестигранный шлиц



6-lobe

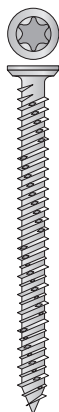

CrVI Free

inBlister®
p. 474

Item code	Screw size Ø x L / L ₁ (mm)	Pcs. per box	Pcs. per carton
Ø 7,5 / T-30 / pre-drilling hole: 6 mm			
GS 01 75 050	7,5 x 50 / 47	100	1.000
GS 01 75 060	7,5 x 60 / 57	100	1.000
GS 01 75 070	7,5 x 70 / 67	100	1.000
GS 01 75 080	7,5 x 80 / 77	100	1.000
GS 01 75 090	7,5 x 90 / 87	100	1.000
GS 01 75 100	7,5 x 100 / 97	100	1.000
GS 01 75 110	7,5 x 110 / 107	100	1.000
GS 01 75 120	7,5 x 120 / 117	100	500
GS 01 75 135	7,5 x 135 / 132	100	500
GS 01 75 150	7,5 x 150 / 147	100	500
GS 01 75 160	7,5 x 160 / 157	100	500
GS 01 75 180	7,5 x 180 / 177	100	500
GS 01 75 200	7,5 x 200 / 197	100	500
GS 01 75 220	7,5 x 220 / 217	100	500
GS 01 75 250	7,5 x 250 / 247	100	300
GS 01 75 300	7,5 x 300 / 297	100	300

Installation sequence / Instructions de mise en oeuvre / Setzanweisung / Secuencia de instalación / Порядок монтажа

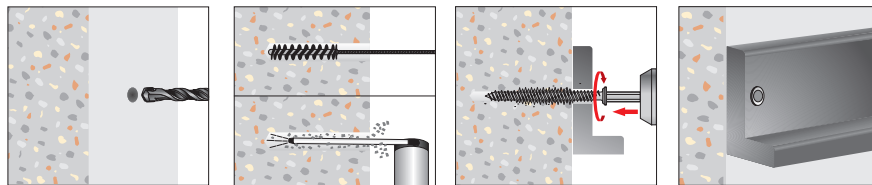

Pre-drilling hole / Trou de préparation / Vorbereitungsloch / Pretaladrar / Предварительное сверление: Ø6 mm

Technical Data Sheet



Box / Boîte / Verpackung / Caja / Упаковка

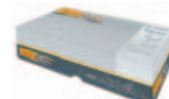

GSC

Small coloured plastic cap fitting 6-lobe recess screw

- Cache - tête en plastique coloré pour vis à six lobes
- Gefärbte Plastik- Abdeckkappe für Innensechsrund- Schrauben
- Tapón de plástico colorado para tornillos cabeza 6 lóbulos internos
- Пластиковая цветная заглушка для шурупов с шестигранным шлицем



GSC 01
RAL 1013
Oyster white



GSC 02
RAL 8004
Copper brown



GSC 04
RAL 9005
Jet black

Item code	Size	Pcs. per bag	Pcs. per carton
GSC 01 00 030	T-30	100	5.000
GSC 02 00 030	T-30	100	5.000
GSC 04 00 030	T-30	100	5.000

GS 02

6-lobe recess pan head concrete screw (Hi-Lo thread), hardened, zinc plated

Vis à béton (filet Hi-Lo) tête cylindrique à six lobes X, cémentée et zinguée

Zylinderkopf- Betonschraube (Hi-Lo Gewinde) mit Innensechsrund, einsatzgehärtet, verzinkt

Tornillo para hormigón (rosca Hi-Lo), cabeza cilíndrica 6 lóbulos internos, acero cementado, cincado

Шуруп по бетону из закаленной стали (резьба Hi-Lo) с цилиндрической головкой с шестигранным шлицем

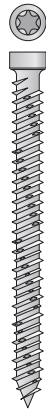

6 lobe



CrVI Free

Item code	Screw size Ø x L / L ₁ (mm)	Pcs. per box	Pcs. per carton
Ø 5 / T-15 / pre-drilling hole: 4 mm			
GS 02 50 052	5 x 52 / 46	200	2.000
GS 02 50 062	5 x 62 / 56	200	2.000
GS 02 50 072	5 x 72 / 66	100	1.000
GS 02 50 082	5 x 82 / 76	100	1.000
GS 02 50 092	5 x 92 / 86	100	1.000
GS 02 50 102	5 x 102 / 96	100	1.000
GS 02 50 112	5 x 112 / 106	100	1.000
Ø 7,5 / T-30 / pre-drilling hole: 6 mm			
GS 02 75 050	7,5 x 50 / 47	100	1.000
GS 02 75 060	7,5 x 60 / 57	100	1.000
GS 02 75 070	7,5 x 70 / 67	100	1.000
GS 02 75 080	7,5 x 80 / 77	100	1.000
GS 02 75 090	7,5 x 90 / 87	100	1.000
GS 02 75 100	7,5 x 100 / 97	100	1.000
GS 02 75 110	7,5 x 110 / 107	100	1.000
GS 02 75 120	7,5 x 120 / 117	100	500
GS 02 75 135	7,5 x 135 / 132	100	500
GS 02 75 150	7,5 x 150 / 147	100	500
GS 02 75 160	7,5 x 160 / 157	100	500
GS 02 75 180	7,5 x 180 / 177	100	500
GS 02 75 200	7,5 x 200 / 197	100	500
GS 02 75 220	7,5 x 220 / 217	100	500
GS 02 75 250	7,5 x 250 / 247	100	300
GS 02 75 300	7,5 x 300 / 297	100	300

Installation sequence / Instructions de mise en oeuvre / Setzanweisung / Secuencia de instalación / Порядок монтажа

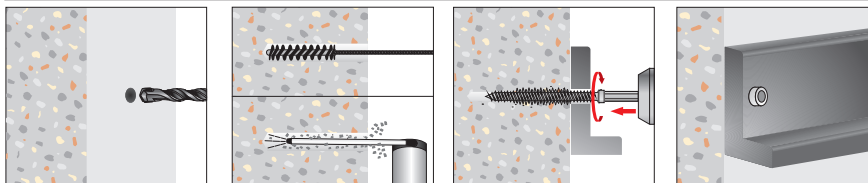

Pre-drilling hole / Trou de préparation / Vorbereitungsloch / Pretaladrar / Предварительное сверление:
 Ø5: predrill Ø4 mm - Ø7,5: predrill Ø6 mm

Technical
Data Sheet



Box / Boîte / Verpackung / Caja / Упаковка

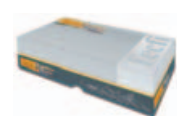

YZ 01 - BE 01 - YZ 51

Multi-expansion countersunk head nylon anchor with zinc plated raised countersunk head nail screw

Cheville en nylon multi-expansion à collerette fraisée, avec vis à clou tête bombée zinguée

Nylonspreizdübel mit Senksaum und verzinkter Senkkopf- Nagelschraube

Taco clavo multiexpansión de nylon con collarín avellanado, montado con tornillo con cabeza avellanada abombada de acero cincado

Многораспорный нейлоновый дюбель-гвоздь с плоским бортом в комплекте с оцинкованным шурупом с плоской потайной головкой

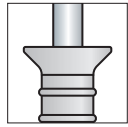

Cross Type Z



CrVI Free



inBlister®
p. 474

Technical
Data Sheet



Item code	Anchor size Ø x L / t _{fix} (mm)	Screw size Øs x Ls (mm)	Pcs. per box	Pcs. per carton
Ø 5 / Pz 2				
YZ 01 05 030	5 x 30 / 5	3,4 x 35	200	2.000
YZ 01 05 040	5 x 40 / 15	3,4 x 45	200	2.000
YZ 01 05 050	5 x 50 / 25	3,4 x 55	200	2.000
Ø 6 / Pz 2				
YZ 01 06 035	6 x 35 / 5	3,8 x 40	200	2.000
YZ 01 06 040	6 x 40 / 10	3,8 x 45	200	2.000
YZ 01 06 050	6 x 50 / 20	3,8 x 55	200	2.000
YZ 01 06 060	6 x 60 / 30	3,8 x 65	200	2.000
YZ 01 06 080	6 x 80 / 50	3,8 x 85	200	2.000
YZ 01 06 100	6 x 100 / 70	3,8 x 105	100	1.000
Ø 8 / Pz 3				
YZ 01 08 045	8 x 45 / 5	4,6 x 50	200	2.000
YZ 01 08 060	8 x 60 / 20	4,6 x 65	100	1.000
YZ 01 08 080	8 x 80 / 40	4,6 x 85	100	1.000
YZ 01 08 100	8 x 100 / 60	4,6 x 105	100	1.000
YZ 01 08 120	8 x 120 / 80	4,6 x 125	50	500
YZ 01 08 135	8 x 135 / 95	4,6 x 140	50	500
YZ 01 08 160	8 x 160 / 125	4,6 x 165	50	500
Ø 10 / Pz 3				
BE 01 10 080	10 x 80 / 20	6 x 85	100	1.000
BE 01 10 100	10 x 100 / 40	6 x 105	50	500
BE 01 10 120	10 x 120 / 60	6 x 125	50	500
BE 01 10 135	10 x 135 / 75	6 x 140	50	500
BE 01 10 160	10 x 160 / 100	6 x 165	50	500

Delivered as BE 01 until stockout, then YZ 01 / Livré comme BE 01 jusqu'à épuisement de stock, puis YZ 01 / Geliiefert als BE 01 bis Lagerende, danach als YZ 01 geliefert / BE 01 hasta agotar existencias. Luego se entregará el producto YZ 01 / YZ01 только после окончания срока BE01

YZ 51 with **A2 (AISI 304)** stainless steel screw / avec vis en acier Inox **A2 (AISI 304)** / mit Edelstahlschraube **A2 (AISI 304)** / con tornillo especial de acero Inoxidable **A2 (AISI 304)** / с шурупом из нержавеющей стали **A2 (AISI 304)**

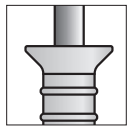

Cross Type Z



Stainless Steel

Item code	Anchor size Ø x L / t _{fix} (mm)	Screw size Øs x Ls (mm)	Pcs. per box	Pcs. per carton
Ø 5 / Pz 2				
YZ 51 05 030	5 x 30 / 5	3,4 x 35	200	2.000
YZ 51 05 050	5 x 50 / 25	3,4 x 55	200	2.000
Ø 6 / Pz 2				
YZ 51 06 040	6 x 40 / 10	3,8 x 45	200	2.000
YZ 51 06 050	6 x 50 / 20	3,8 x 55	200	2.000
YZ 51 06 060	6 x 60 / 30	3,8 x 65	200	2.000
YZ 51 06 080	6 x 80 / 50	3,8 x 85	200	2.000
YZ 51 06 100	6 x 100 / 70	3,8 x 105	100	1.000
Ø 8 / Pz 3				
YZ 51 08 060	8 x 60 / 20	4,6 x 65	100	1.000
YZ 51 08 080	8 x 80 / 40	4,6 x 85	100	1.000
YZ 51 08 100	8 x 100 / 60	4,6 x 105	100	1.000
YZ 51 08 120	8 x 120 / 80	4,6 x 125	50	500
YZ 51 08 135	8 x 135 / 95	4,6 x 140	50	500

Installation sequence / Instructions de mise en oeuvre / Setzanweisung / Secuencia de instalación / Порядок монтажа

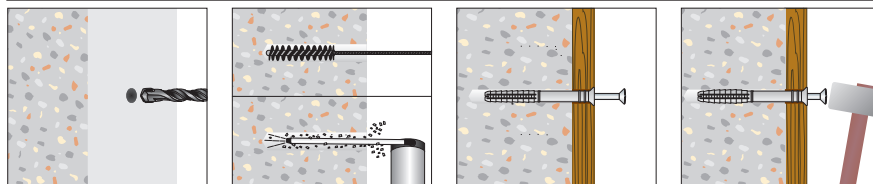

To be hammered, for light fixings of panels, interior design items, gutter/thinsmiths, drywall steel frames..., on concrete, solid masonry, hollow masonry, perforated masonry.

Technical
Data Sheet



Box / Boîte / Verpackung
Caja / Упаковка



YZ 31 - BE 06 - YZ 52

Multi-expansion cylinder head nylon anchor with zinc plated flat countersunk head nail screw

Cheville en nylon multi-expansion à collerette cylindrique, avec vis à clou tête bombée zinguée

Multierweiterungs Nyldübel mit Zylindersaum und verzinkter Zylinderkopf- Nagelschraube

Taco clavo multiexpansión de nylon con collarín cilíndrico, montado con tornillo con cabeza avellanada abombada de acero cincado

Многораспорный нейлоновый дюбель-гвоздь с цилиндрическим бортом в комплекте с оцинкованным шурупом с плоской потайной головкой

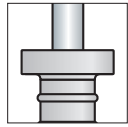

Cross Type Z

CrVI Free

Technical Data Sheet



Item code	Anchor size Ø x L / t _{fix} (mm)	Screw size Øs x Ls (mm)	Pcs. per box	Pcs. per carton
Ø 5 / Pz 2				
* BE 06 05 025	5 x 25 / 1	3,4 x 30	200	2.000
YZ 31 05 030	5 x 30 / 3	3,4 x 35	200	2.000
* BE 06 05 035	5 x 35 / 10	3,4 x 40	200	2.000
YZ 31 05 040	5 x 40 / 13	3,4 x 45	200	2.000
* BE 06 05 045	5 x 45 / 20	3,4 x 50	200	2.000
YZ 31 05 050	5 x 50 / 23	3,4 x 55	200	2.000
Ø 6 / Pz 2				
YZ 31 06 035	6 x 35 / 3	3,8 x 40	200	2.000
YZ 31 06 040	6 x 40 / 8	3,8 x 45	200	2.000
YZ 31 06 050	6 x 50 / 18	3,8 x 55	200	2.000
YZ 31 06 060	6 x 60 / 28	3,8 x 65	200	2.000
YZ 31 06 080	6 x 80 / 48	3,8 x 85	200	2.000
YZ 31 06 100	6 x 100 / 68	3,8 x 105	100	1.000
Ø 8 / Pz 3				
YZ 31 08 045	8 x 45 / 2	4,6 x 50	200	2.000
YZ 31 08 060	8 x 60 / 17	4,6 x 65	200	2.000
YZ 31 08 080	8 x 80 / 37	4,6 x 85	100	1.000
YZ 31 08 100	8 x 100 / 57	4,6 x 105	100	1.000
YZ 31 08 120	8 x 120 / 77	4,6 x 125	50	500
YZ 31 08 135	8 x 135 / 92	4,6 x 140	50	500
YZ 31 08 160	8 x 160 / 117	4,6 x 165	50	500

Delivered as BE 06 until stockout, then YZ 31 / Livré comme BE 06 jusqu'à épuisement de stock, puis YZ 31 / Geliefert als BE 06 bis Lagerende, danach als YZ 31 geliefert. / BE 06 hasta agotar existencias. Luego se entregará el producto YZ 31 / YZ31 только после окончания стока BE06

* Until stockout / Jusqu'à épuisement des stocks / Solange der Vorrat reicht / Hasta agotar existencias / до окончания стока



YZ 52 with A2 (AISI 304) stainless steel screw / avec vis en acier Inox A2 (AISI 304) / mit Edelstahlschraube A2 (AISI 304) / con tornillo especial de acero Inoxidable A2 (AISI 304) / с шурупом из нержавеющей стали A2 (AISI 304)

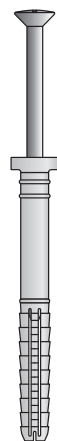
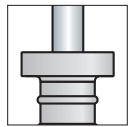

Cross Type Z

A2
Stainless Steel

Item code	Anchor size Ø x L / t _{fix} (mm)	Screw size Øs x Ls (mm)	Pcs. per box	Pcs. per carton
Ø 5 / Pz 2				
YZ 52 05 030	5 x 30 / 3	3,4 x 35	200	2.000
YZ 52 05 050	5 x 50 / 23	3,4 x 55	200	2.000
Ø 6 / Pz 2				
YZ 52 06 040	6 x 40 / 8	3,8 x 45	200	2.000
YZ 52 06 050	6 x 50 / 18	3,8 x 55	200	2.000
YZ 52 06 060	6 x 60 / 28	3,8 x 65	200	2.000
YZ 52 06 080	6 x 80 / 48	3,8 x 85	200	2.000
YZ 52 06 100	6 x 100 / 68	3,8 x 105	100	1.000
Ø 8 / Pz 3				
YZ 52 08 060	8 x 60 / 17	4,6 x 65	200	2.000
YZ 52 08 080	8 x 80 / 37	4,6 x 85	100	1.000
YZ 52 08 100	8 x 100 / 57	4,6 x 105	100	1.000
YZ 52 08 120	8 x 120 / 77	4,6 x 125	50	500
YZ 52 08 135	8 x 135 / 95	4,6 x 140	50	500

Installation sequence / Instructions de mise en oeuvre / Setzanweisung / Secuencia de instalación / Порядок монтажа

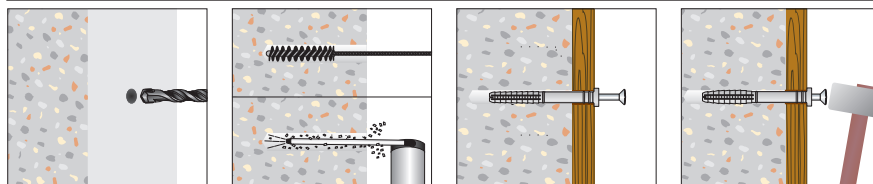

To be hammered, for light fixings of panels, interior design items, gutter/thinsmiths, drywall steel frames..., on concrete, solid masonry, hollow masonry, perforated masonry.

Technical Data Sheet







Box / Boîte / Verpackung
Caja / Упаковка



CN 01

Extended countersunk head nylon anchor with two wings





-  Cheville en nylon rallongée avec collerette fraisée, avec deux ailettes
-  Nylon- Langschaftdübel mit Senksaum und zwei Flügel
-  Taco largo de nylon con collarín avellanado, con dos alas
-  Удлиненный нейлоновый дюбель с двумя блокировочными усам



Item code	Anchor size Ø x L (mm)	Pcs. per box	Pcs. per carton
Ø 6			
CN 01 06 040	6 x 40	200	2.000
CN 01 06 060	6 x 60	200	2.000
CN 01 06 080	6 x 80	200	2.000
Ø 8			
CN 01 08 060	8 x 60	100	1.000
CN 01 08 080	8 x 80	100	1.000
CN 01 08 100	8 x 100	100	1.000
CN 01 08 120	8 x 120	100	1.000
CN 01 08 135	8 x 135	100	1.000
Ø 10			
CN 01 10 060	10 x 60	100	1.000
CN 01 10 080	10 x 80	100	1.000
CN 01 10 100	10 x 100	100	1.000
CN 01 10 115	10 x 115	100	1.000
CN 01 10 135	10 x 135	50	500
CN 01 10 160	10 x 160	50	500

CN 02

Extended countersunk head nylon anchor with six wings

-  Cheville en nylon rallongée avec collerette fraisée, avec six ailettes
-  Nylon- Langschaftdübel mit Senksaum und sechs Flügel
-  Taco largo de nylon con collarín avellanado, con seis alas
-  Удлиненный нейлоновый дюбель с шестью блокировочными усам



Item code	Anchor size Ø x L (mm)	Pcs. per box	Pcs. per carton
Ø 8			
CN 02 08 080	8 x 80	100	1.000
CN 02 08 100	8 x 100	100	1.000
CN 02 08 120	8 x 120	100	1.000
Ø 10			
CN 02 10 080	10 x 80	100	1.000
CN 02 10 100	10 x 100	100	1.000
CN 02 10 115	10 x 115	100	1.000
CN 02 10 135	10 x 135	50	500
CN 02 10 160	10 x 160	50	500
CN 02 10 200	10 x 200	50	500

Box / Boîte / Verpackung / Caja / Упаковка

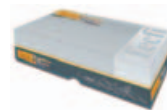

BE 02 - BE 04

 **Countersunk head Nylon anchor with zinc plated cross type Z recess flat countersunk head special wood screw**

 Cheville en nylon avec collerette fraisée et vis à bois tête fraisée plate empreinte cruciformes Type Z, zinguée

 Nyldübel mit Senkbaum mit spezieller Kreuzschlitz Z Senkkopf-Holzschraube, verzinkt

 Taco de nylon con collarín avellanado, con tornillo especial para madera con cabeza avellanada cruz tipo Z de acero cincado

 Нейлоновый анкер в комплекте с оцинкованным шурупом с плоской потайной головкой с крестообразным шлицем типа Z

BE 02 anchor with two wings / avec deux ailettes / mit zwei Flügel / con dos alas / Дюбель с двумя блокировочными усам



Cross Type Z







CrVI Free

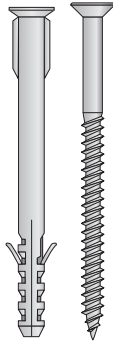

inBlister®
p. 474



Item code	Anchor size Ø x L / t _{fix} (mm)	Screw size Øs x Ls (mm)	Pcs. per box	Pcs. per carton
Ø 6 / Pz 2				
 BE 02 06 040	6 x 40 / 10	4 x 45	200	2.000
 BE 02 06 060	6 x 60 / 10	4 x 65	200	2.000
 BE 02 06 080	6 x 80 / 30	4 x 85	200	2.000
Ø 8 / Pz 3				
 BE 02 08 060	8 x 60 / 20	5,5 x 65	100	1.000
BE 02 08 080	8 x 80 / 40	5,5 x 85	100	1.000
 BE 02 08 100	8 x 100 / 40	5,5 x 105	100	1.000
BE 02 08 120	8 x 120 / 60	5,5 x 125	100	1.000
BE 02 08 135	8 x 135 / 75	5,5 x 140	100	1.000
Ø 10 / Pz 4				
BE 02 10 060	10 x 60 / 10	7 x 65	100	1.000
BE 02 10 080	10 x 80 / 30	7 x 85	50	500
BE 02 10 100	10 x 100 / 50	7 x 105	50	500
BE 02 10 115	10 x 115 / 55	7 x 120	50	500
BE 02 10 135	10 x 135 / 75	7 x 140	50	500
BE 02 10 160	10 x 160 / 100	7 x 165	50	500

Usage / Utilisation / Benutzung / Uso / Применение

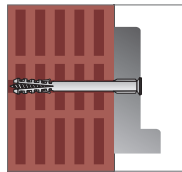

Technical Data Sheet



Box / Boîte / Verpackung / Caja / Упаковка

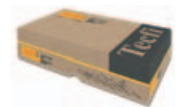

BE 04 anchor with six wings / avec six ailettes / mit sechs Flügel / con seis alas / Дюбель с шестью блокировочными усам



Cross Type Z



CrVI Free

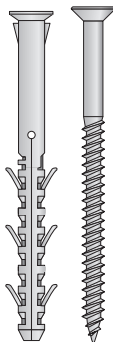

Item code	Anchor size Ø x L / t _{fix} (mm)	Screw size Øs x Ls (mm)	Pcs. per box	Pcs. per carton
Ø 8 / Pz 3				
BE 04 08 080	8 x 80 / 20	5,5 x 85	100	1.000
BE 04 08 100	8 x 100 / 40	5,5 x 105	100	1.000
BE 04 08 120	8 x 120 / 60	5,5 x 125	100	1.000
Ø 10 / Pz 4				
BE 04 10 080	10 x 80 / 20	7 x 85	50	500
BE 04 10 100	10 x 100 / 40	7 x 105	50	500
BE 04 10 115	10 x 115 / 55	7 x 120	50	500
BE 04 10 135	10 x 135 / 75	7 x 140	50	500
BE 04 10 160	10 x 160 / 100	7 x 165	50	500
BE 04 10 200	10 x 200 / 140	7 x 205	50	250

Usage / Utilisation / Benutzung / Uso / Применение

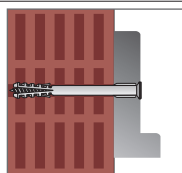

Technical Data Sheet



Box / Boîte / Verpackung / Caja / Упаковка



BE 08 - BE 09

Countersunk head nylon anchor with zinc plated 6-lobe recess flat countersunk head special wood screw

Cheville en nylon avec collerette fraisée, avec vis à bois tête fraisée plate à six lobes, zinguée

Nylondübel mit Senksaum und spezieller Innensechsrund Senkkopf-Holzschraube, verzinkt

Taco de nylon con collarín avellanado, con tornillo especial para madera con cabeza avellanada 6 lóbulos internos de acero cincado

Нейлоновый анкер в комплекте с оцинкованным шурупом с плоской потайной головкой с шестигранным шлицем

BE 08 anchor with two wings / avec deux ailettes / mit zwei Flügel / con dos alas / Дюбель с двумя блокировочными усам

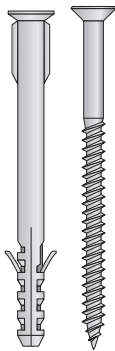

Item code	Anchor size $\varnothing \times L / t_{fix}$ (mm)	Screw size $\varnothing_s \times L_s$ (mm)	Pcs. per box	Pcs. per carton
$\varnothing 8 / T-30$				
BE 08 08 060	8 x 60 / 20	5,5 x 65	100	1.000
BE 08 08 080	8 x 80 / 40	5,5 x 85	100	1.000
BE 08 08 100	8 x 100 / 40	5,5 x 105	100	1.000
BE 08 08 120	8 x 120 / 60	5,5 x 125	100	1.000
BE 08 08 135	8 x 135 / 75	5,5 x 140	100	1.000
$\varnothing 10 / T-40$				
BE 08 10 080	10 x 80 / 30	7 x 85	50	500
BE 08 10 100	10 x 100 / 50	7 x 105	50	500
BE 08 10 115	10 x 115 / 55	7 x 120	50	500
BE 08 10 135	10 x 135 / 75	7 x 140	50	500
BE 08 10 160	10 x 160 / 100	7 x 165	50	500

Technical Data Sheet



Usage / Utilisation / Benutzung / Uso / Применение

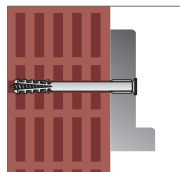

Box / Boîte / Verpackung / Caja / Упаковка



BE 09 anchor with six wings / avec six ailettes / mit sechs Flügel / con seis alas / Дюбель с шестью блокировочными усам

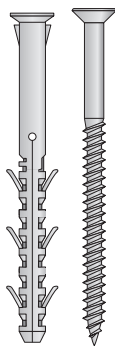

Item code	Anchor size $\varnothing \times L / t_{fix}$ (mm)	Screw size $\varnothing_s \times L_s$ (mm)	Pcs. per box	Pcs. per carton
$\varnothing 8 / T-30$				
BE 09 08 080	8 x 80 / 20	5,5 x 85	100	1.000
BE 09 08 100	8 x 100 / 40	5,5 x 105	100	1.000
BE 09 08 120	8 x 120 / 60	5,5 x 125	100	1.000
$\varnothing 10 / T-40$				
BE 09 10 080	10 x 80 / 20	7 x 85	50	500
BE 09 10 100	10 x 100 / 40	7 x 105	50	500
BE 09 10 115	10 x 115 / 55	7 x 120	50	500
BE 09 10 135	10 x 135 / 75	7 x 140	50	500
BE 09 10 160	10 x 160 / 100	7 x 165	50	500
BE 09 10 200	10 x 200 / 140	7 x 205	50	250

Technical Data Sheet



Usage / Utilisation / Benutzung / Uso / Применение

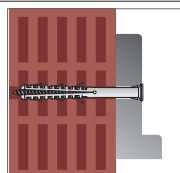

Box / Boîte / Verpackung / Caja / Упаковка



BE 03 - BE 05

Countersunk head nylon anchor with zinc plated hex head special wood screw

Cheville en nylon avec collerette fraisée et vis à bois tête hexagonale, zinguée

Nylondübel mit Senksaum, mit spezieller Sechskant-Holzschraube, verzinkt

Taco de nylon con collarín avellanado, con tornillo especial para madera con cabeza hexagonal de acero cincado

Нейлоновый анкер в комплекте с оцинкованным шурупом с шестигранной головкой

BE 03 anchor with two wings / avec deux ailettes / mit zwei Flügel / con dos alas / Дюбель с двумя блокировочными усам

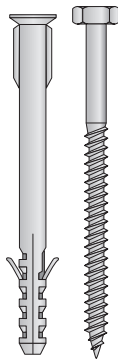

Item code	Anchor size $\varnothing \times L / t_{fix}$ (mm)	Screw size $\varnothing s \times Ls$ (mm)	Pcs. per box	Pcs. per carton
$\varnothing 8$ / SW: 10				
BE 03 08 060	8 x 60 / 20	5,5 x 65	100	1.000
BE 03 08 080	8 x 80 / 40	5,5 x 85	100	1.000
BE 03 08 100	8 x 100 / 40	5,5 x 105	100	1.000
BE 03 08 120	8 x 120 / 60	5,5 x 125	100	1.000
BE 03 08 135	8 x 135 / 75	5,5 x 140	100	1.000
$\varnothing 10$ / SW: 12				
BE 03 10 060	10 x 60 / 10	7 x 65	100	1.000
BE 03 10 080	10 x 80 / 30	7 x 85	50	500
BE 03 10 100	10 x 100 / 50	7 x 105	50	500
BE 03 10 115	10 x 115 / 55	7 x 120	50	500
BE 03 10 135	10 x 135 / 75	7 x 140	50	500
BE 03 10 160	10 x 160 / 100	7 x 165	50	500



Usage / Utilisation / Benutzung / Uso / Применение

Box / Boîte / Verpackung / Caja / Упаковка

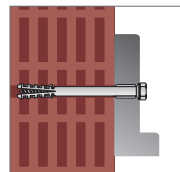

BE 05 anchor with six wings / avec six ailettes / mit sechs Flügel / con seis alas / Дюбель с шестью блокировочными усам

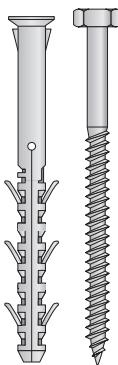

Item code	Anchor size $\varnothing \times L / t_{fix}$ (mm)	Screw size $\varnothing s \times Ls$ (mm)	Pcs. per box	Pcs. per carton
$\varnothing 8$ / SW: 10				
BE 05 08 080	8 x 80 / 20	5,5 x 85	100	1.000
BE 05 08 100	8 x 100 / 40	5,5 x 105	100	1.000
BE 05 08 120	8 x 120 / 60	5,5 x 125	100	1.000
$\varnothing 10$ / SW: 12				
BE 05 10 080	10 x 80 / 20	7 x 85	50	500
BE 05 10 100	10 x 100 / 40	7 x 105	50	500
BE 05 10 115	10 x 115 / 55	7 x 120	50	500
BE 05 10 135	10 x 135 / 75	7 x 140	50	500
BE 05 10 160	10 x 160 / 100	7 x 165	50	500
BE 05 10 200	10 x 200 / 140	7 x 205	50	250



Usage / Utilisation / Benutzung / Uso / Применение

Box / Boîte / Verpackung / Caja / Упаковка

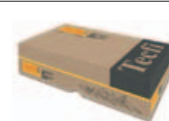
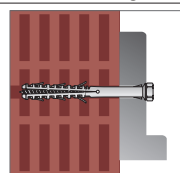



BE 10 - BE 11

 **Countersunk head nylon anchor with zinc plated 6-lobe recess mushroom head special and hardened wood screw, and 6-lobe cap**

 Cheville en nylon avec collerette fraisée et vis à bois tête bombée à six lobes, en acier cémenté, zinguée et cache-tête à six lobes

 Nylohdübel mit Senksaum und spezieller Innensechsrund Rundkopf-Holzschraube, einsetzgehärtet, verzinkt, und Innensechsrund- Einschalgstern

 Taco de nylon con collarín avellanado, con tornillo especial para madera con cabeza abombada 6 lóbulos internos de acero cementado cincado, con tapón clavable

 Нейлоновый анкер в комплекте с оцинкованным шурупом из закаленной стали с низкой полукруглой головкой с шестигранным шлицем, и с шестигранным колпачком-заглушкой

BE 10 anchor with two wings / avec deux ailettes / mit zwei Flügel / con dos alas / Дюбель с двумя блокировочными усам

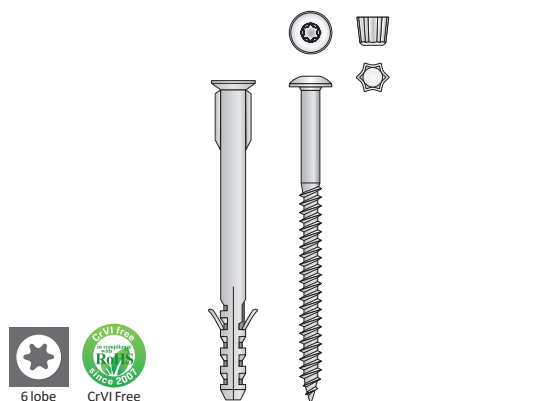

Item code	Anchor size $\varnothing \times L / t_{fix}$ (mm)	Screw size $\varnothing s \times Ls$ (mm)	Pcs. per box	Pcs. per carton
$\varnothing 10 / T-40$				
BE 10 10 060	10 x 60 / 10	7 x 65	50	500
BE 10 10 080	10 x 80 / 30	7 x 85	50	500
BE 10 10 100	10 x 100 / 50	7 x 105	50	500
BE 10 10 115	10 x 115 / 55	7 x 120	50	500
BE 10 10 135	10 x 135 / 75	7 x 140	50	500
BE 10 10 160	10 x 160 / 100	7 x 165	50	500

BE 11 anchor with six wings / avec six ailettes / mit sechs Flügel / con seis alas / Дюбель с шестью блокировочными усам

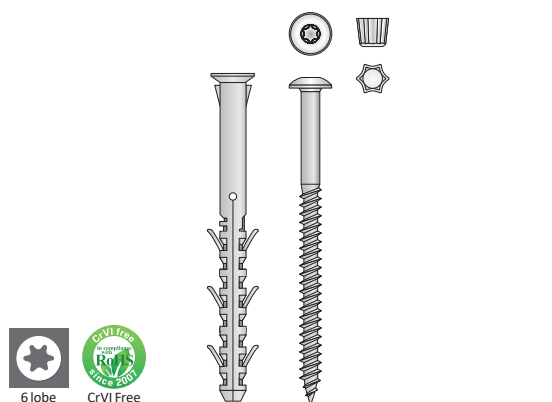

Item code	Anchor size $\varnothing \times L / t_{fix}$ (mm)	Screw size $\varnothing s \times Ls$ (mm)	Pcs. per box	Pcs. per carton
$\varnothing 10 / T-40$				
BE 11 10 080	10 x 80 / 20	7 x 85	50	500
BE 11 10 100	10 x 100 / 40	7 x 105	50	500
BE 11 10 115	10 x 115 / 55	7 x 120	50	500
BE 11 10 135	10 x 135 / 75	7 x 140	50	500
BE 11 10 160	10 x 160 / 100	7 x 165	50	500
BE 11 10 200	10 x 200 / 140	7 x 205	50	250

Technical
Data Sheet



Usage / Utilisation / Benutzung / Uso / Применение



Box / Boîte / Verpackung / Caja / Упаковка



BE 72

Countersunk head nylon anchor with six wings, with A4-70 (AISI 316) stainless steel 6-lobe recess flat countersunk head special wood screw

- Cheville en nylon tête fraisée plate avec six ailettes, avec vis spéciale à bois en acier Inox A4-70 (AISI 316) tête fraisée plate empreinte à six lobes
- Nylondübel mit Senksaum mit sechs Flügel, mit Edelstahl A4-70 (AISI 316) Innensechsrund Senkkopf-Holzschraube
- Taco de nylon a seis alas con collarín avellanado, con tornillo especial para madera con cabeza avellanada 6 lóbulos internos de acero inoxidable A4-70 (AISI 316)
- Нейлоновый дюбель с шестью блокировочными усями в комплекте с шурупом из нержавеющей стали A4-70 (AISI 316) с плоской потайной головкой с шестигранным шлицем

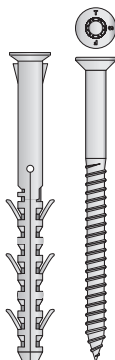

Item code	Anchor size $\varnothing \times L / t_{fix}$ (mm)	Screw size $\varnothing s \times Ls$ (mm)	Pcs. per box	Pcs. per carton
$\varnothing 8 / T-30$				
BE 72 08 080	8 x 80 / 20	6 x 85	100	1.000
BE 72 08 100	8 x 100 / 40	6 x 105	100	1.000
BE 72 08 120	8 x 120 / 60	6 x 125	100	1.000
$\varnothing 10 / T-40$				
BE 72 10 080	10 x 80 / 20	7 x 85	50	500
BE 72 10 100	10 x 100 / 40	7 x 105	50	500
BE 72 10 115	10 x 115 / 55	7 x 125	50	500
BE 72 10 135	10 x 135 / 75	7 x 145	50	500
BE 72 10 160	10 x 160 / 100	7 x 165	50	500
BE 72 10 200	10 x 200 / 140	7 x 205	50	250

BE 74

Countersunk head nylon anchor with six wings, with A4-70 (AISI 316) stainless steel 6-lobe recess hexagonal washer head special wood screw

- Cheville en nylon tête fraisée plate avec six ailettes, avec vis spéciale à bois en acier Inox A4-70 (AISI 316) tête hexagonale empreinte à six lobes
- Nylondübel mit Senksaum und sechs Flügel, mit Edelstahl A4-70 (AISI 316) Innensechsrund Sechskant-Holzschraube
- Taco de nylon a seis alas con collarín avellanado, con tornillo especial para madera con cabeza hexagonal arandela estampada 6 lóbulos
- Нейлоновый дюбель с шестью блокировочными усями в комплекте с специальным шурупом из нержавеющей стали A4-70 (AISI 316) с шестигранной головкой и шестигранным шлицем

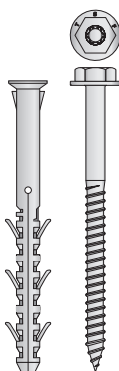

Item code	Anchor size $\varnothing \times L / t_{fix}$ (mm)	Screw size $\varnothing s \times Ls$ (mm)	Pcs. per box	Pcs. per carton
$\varnothing 8 / T-30 / SW: 10$				
BE 74 08 080	8 x 80 / 20	6 x 85	100	1.000
BE 74 08 100	8 x 100 / 40	6 x 105	100	1.000
BE 74 08 120	8 x 120 / 60	6 x 125	100	1.000
$\varnothing 10 / T-40 / SW: 13$				
BE 74 10 080	10 x 80 / 20	7 x 85	50	500
BE 74 10 100	10 x 100 / 40	7 x 105	50	500
BE 74 10 115	10 x 115 / 55	7 x 125	50	500
BE 74 10 135	10 x 135 / 75	7 x 145	50	500
BE 74 10 160	10 x 160 / 100	7 x 165	50	500
BE 74 10 200	10 x 200 / 140	7 x 205	50	250

Usage / Utilisation / Benutzung / Uso / Применение

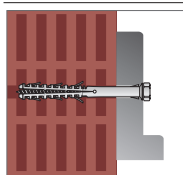





For fixing on concrete, solid masonry, hollow masonry.

Box / Boîte / Verpackung / Caja / Упаковка



HH 00

Extended rimmed nylon anchor with eight wings

-  Cheville en nylon rallongée, bordée, avec huit ailettes
-  Verlängerter Nylonanker mit Rand und acht Flügeln
-  Taco largo de nylon con collarín, con ocho alas
-  Удлиненный нейлоновый дюбель с бортом с восьмью блокировочными усами







Item code	Anchor size Ø x L (mm)	Pcs. per box
Ø 12		
HH 00 12 160	12 x 160	50
HH 00 12 200	12 x 200	50
HH 00 12 240	12 x 240	50
Ø 16		
HH 00 16 140	16 x 140	50
HH 00 16 160	16 x 160	50
HH 00 16 200	16 x 200	50
HH 00 16 240	16 x 240	50

Box / Boîte / Verpackung / Caja / Упаковка



HH 01

Extended rimmed nylon anchor with eight wings with zinc plated hex head wood screw and large washer

-  Cheville en nylon rallongée, bordée, avec huit ailettes, avec vis à bois tête hexagonale zinguée et rondelle large
-  Verlängerter Nylo Dübel mit acht Flügeln, mit verzinkter Sechskant-Holzschraube und großer Unterlegscheibe
-  Taco largo de nylon con collarín con ocho alas, con tornillo para madera con cabeza hexagonal cincado y arandela ancha
-  Удлиненный нейлоновый дюбель с бортом и с восьмью блокировочными усами и оцинкованный шуруп по дереву с широкой шайбой

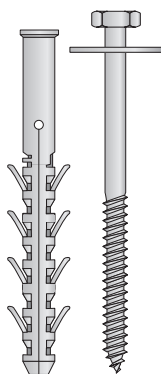

Item code	Anchor size Ø x L / t _{fix} (mm)	Screw size Ø _s x L _s (mm)	Pcs. per box
Ø 12 / SW: 17			
HH 01 12 160	12 x 160 / 60	10 x 160	25
HH 01 12 200	12 x 200 / 100	10 x 200	25
HH 01 12 240	12 x 240 / 140	10 x 240	25
Ø 16 / SW: 19			
HH 01 16 140	16 x 140 / 40	12 x 150	25
HH 01 16 160	16 x 160 / 60	12 x 170	25
HH 01 16 200	16 x 200 / 100	12 x 210	25
HH 01 16 240	16 x 240 / 140	12 x 250	25



Usage / Utilisation / Benutzung / Uso / Применение

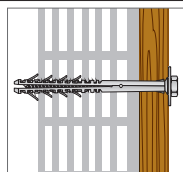

Box / Boîte / Verpackung / Caja / Упаковка



BE 12

Until stockout
 Jusqu'à épuisement de stocks
 Solange der Vorrat reicht
 Hasta agotar existencias
 до окончания стока

🇬🇧 Cylinder head nylon anchor with zinc plated dual thread with ring nail screw

- Cheville en nylon à collerette cylindrique, avec vis double filet zinguée
- Nyldübel mit Zylindersaum und verzinkter Doppelgewindeschraube
- Taco de nylon con collarín cilíndrico, con tornillo clavable doble rosca con anillo de acero cincado
- Нейлоновый дюбель-гвоздь в комплекте с оцинкованным шурупом с двойной резьбой

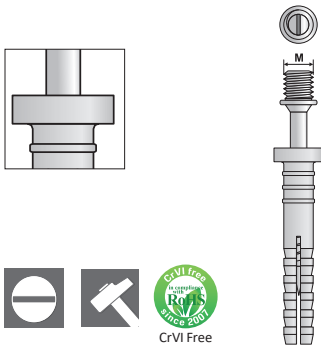

Item code	Anchor size Ø x L (mm)	Screw size Øs x Ls x M	Pcs. per box	Pcs. per carton
Ø 6 / M6				
BE 12 06 060	6 x 60	3,8 x 65 x M6	200	2.000
Ø 8 / M8				
BE 12 08 045	8 x 45	4,8 x 50 x M8	200	2.000
BE 12 08 060	8 x 60	4,8 x 65 x M8	200	2.000



Installation sequence / Instructions de mise en oeuvre / Setzanweisung / Secuencia de instalación / Порядок монтажа

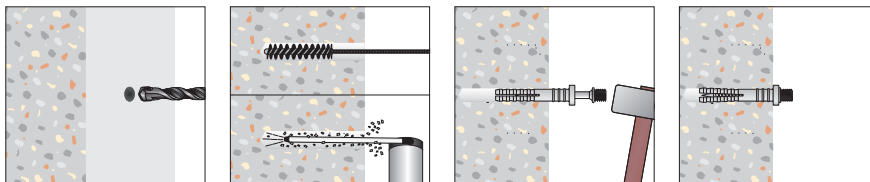

For light fixings on concrete, solid masonry, hollow masonry, perforated masonry.

Technical Data Sheet



Box / Boîte / Verpackung / Caja / Упаковка



WU 02



🇬🇧 Pan head BIMETAL (A2 Stainless Steel + Carbon steel hardened) self drilling screw with reduced point

- Vis autoperceuse bi-métal (Acier INOX A2 + acier au carbone) tête cylindrique avec pointe réduite
- Bimetall Halbrundkopf - Bohrschraube (Edelstahl A2 + Kohlenstoffstahl) mit reduzierter Bohrspitze
- Tornillo autotaladrante BIMETAL (acero inoxidable A2 + acero cementado al carbono), cabeza cilíndrica, con broca reducida
- Самосверлящий шуруп с цилиндрической головкой со скошенным буртом BIMETAL (нержавеющая сталь A2 + углеродистая закаленная сталь) с уменьшенным сверлом



Item code	Screw size Ø x L (mm)	Tfix (Fixture thickness)		Pcs. per box	Pcs. per carton
		min	max		
Ø 4,2 / Ph 2					
WU 02 42 016	4,2 x 16	0,8	4	200	2.000



Usage / Utilisation / Benutzung / Uso / Применение

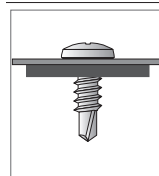

For fixing on thin metal sheet (min 0,5 - max 1 mm);
Pre-drill is NOT required.

Box / Boîte / Verpackung / Caja / Упаковка



Four finged clamp, for hidden fixing of tiles onto façades

- Équerre à quatre pinces, pour le montage de tuiles sur façades
- Klemme mit vier Haken, zur Befestigung von Kachel auf Fassaden
- Clip con cuatro ganchos largos, para la instalación de baldosas en fachada
- Крепежный кляммер рядовой для крепления фасадов и плиток из керамогранита

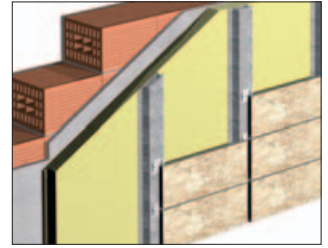
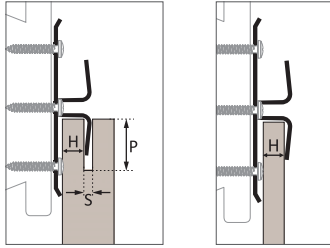
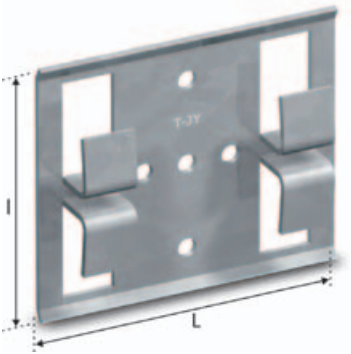

Item code	Clamp size L x l x t (mm)	Thickness of fixture H Min/Max (mm)	Slot depth P Min (mm)	Slot width S Min (mm)	Number of holes*	Holes diameter Ø (mm)	Tile joints F (mm)	Pcs. per carton
Zinc plated steel								
JY 01 05 015	75 x 64 x 1,5	8 / 9	16	2,5	5	4,5	7	250
JY 01 15 015	75 x 64 x 1,5	9 / 10	16	2,5	5	4,5	7	250
A2 (AISI 304) stainless steel								
JY 51 05 010	75 x 64 x 1,0	8 / 9	16	2,5	5	4,5	7	250
JY 51 15 010	75 x 64 x 1,0	9 / 10	16	2,5	5	4,5	7	250

* Different number of holes available on request (minimum quantity and delivery time to be agreed) / Numéros de trous disponible sur demande (quantité et temps de livraison à concorder) / Verschiedene Nummern von Löcher auf Anfrage verfügbar (Menge und Liefertermin zu vereinbaren) / Disponible bajo solicitud con otro número de agujeros (cantidad y plazo de entrega a concordar) / Различные количество отверстий по запросу (количество и срок поставки по договоренности)



Suitable for:

✓ hidden fixing
for slotted (kerf) tiles

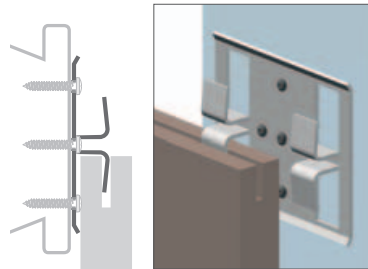

pic. 1

✓ visible fixing
for non-slotted tiles

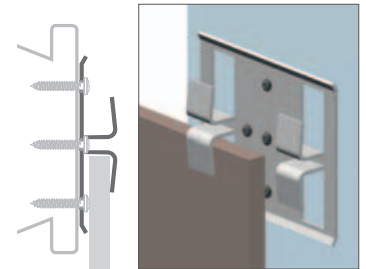

pic. 2

Usage

For hidden fixing (pic. 1) or visible fixing (pic. 2) of tiles.

Two assembly patterns are available:

- A) At the cross of 4 tiles: all holes for screws can be used;
- B) Along the edge of 2 tiles: only the horizontal holes are available for screws.

Assembly patterning:

A) at the cross of 4 tiles*

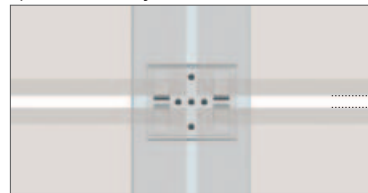

* all holes are available for screws

B) along the edge of 2 tiles*



* horizontal holes only available for screws

Wider edged clamp with four reduced fingers, for hidden fixing of slotted thin tiles onto façades

- Équerre à quatre pinces avec bord accru, pour le montage de tuiles avec coupe
- Klemme mit vier Haken mit verstärktem Rand, zur Befestigung von zugeschnittenen Kachel auf Fassaden
- Clip con cuatro ganchos cortos, para la instalación de baldosas en fachada
- Крепежный кляммер рядовой с четырьмя уменьшенными пальцами зажим с широкими краями, для скрытой фиксации щелевых тонких плиток на фасадах

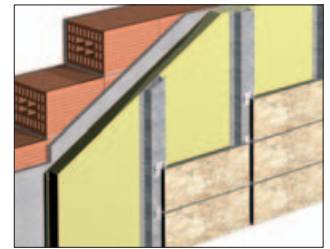
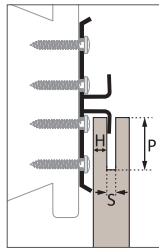
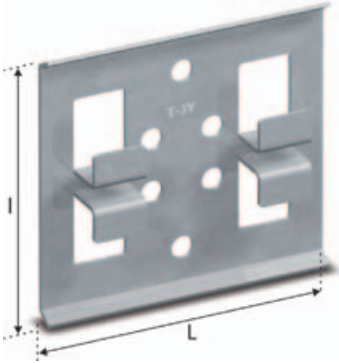

Item code	Clamp size L x l x t (mm)	Thickness of fixture H Min/Max (mm)	Slot depth P Min (mm)	Slot width S Min (mm)	Number of holes*	Holes diameter Ø (mm)	Tile joints F (mm)	Pcs. per carton
Zinc plated steel								
JY 01 26 015	65 x 62 x 1,5	4 / 5	8	2	6	5	7	250
Stainless Steel A2 (AISI 304)								
JY 51 26 010	65 x 62 x 1,0	4 / 5	8	2	6	5	7	250

* Different number of holes available on request (minimum quantity and delivery time to be agreed) / Numéros de trous disponible sur demande (quantité et temps de livraison à concorder) / Verschiedene Nummern von Löcher auf Anfrage verfügbar (Menge und Liefertermin zu vereinbaren) / Disponible bajo solicitud con otro número de agujeros (cantidad y plazo de entrega a concordar) / Различные количество отверстий по запросу (количество и срок поставки по договоренности)



Suitable for:

✓ hidden fixing for slotted (kerf) tiles

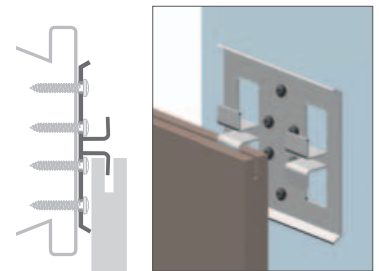

pic. 1

Usage
For hidden fixing (pic. 1) of slotted thin tiles.

Two assembly patterns are available:
A) At the cross of 4 tiles
B) Along the edge of 2 tiles

The special wider edges allows the perfect positioning of the screws under the tiles. So, in both assembly patterns, all holes can be used for screws.

Assembly patterning:

A) at the cross of 4 tiles*

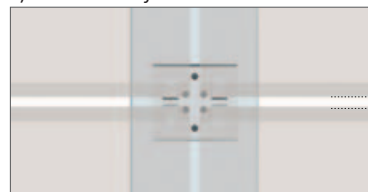

* all holes are available for screws

B) along the edge of 2 tiles*



* all holes are available for screws

XA 31 ^{NEW}

Hexagon through-holed set screw, in aluminium

- 🇫🇷 Bouchon à six pans creux, en aluminium
- 🇩🇪 Gewindestift mit Innensechskant, aus Aluminium
- 🇪🇸 Tornillo hueco sin cabeza con huella hexagonal, de aluminio
- 🇷🇺 Винт установочный, внутренний шестигранник, из алюминия



Item code	Socket size M x L (mm)	Pcs. per box	Pcs. per carton
In-Hex (s): 6 mm			
XA 31 12 020	M12 x 20	200	2.000
XA 31 12 030	M12 x 30	100	1.000
XA 31 12 040	M12 x 40	100	1.000

Installation sequence / Instructions de mise en oeuvre / Setzanweisung / Secuencia de instalación / Порядок монтажа

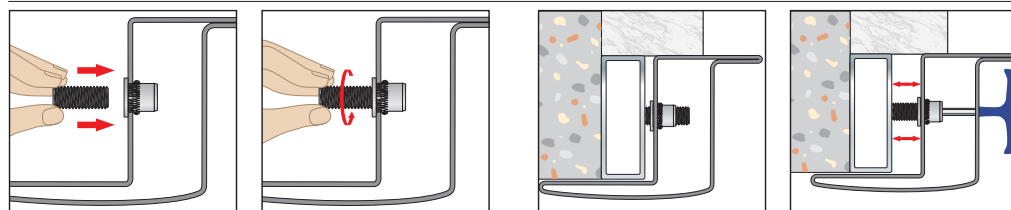

1st step: Drive the hexagon through-holed set screw into the rivet nut (already installed on the frame)

2nd step: Use the hexagon key wrench to adjust the distance between the window (or door) and the frame



Technical Data Sheet

Box / Boîte / Verpackung
Caja / Упаковка



XB 01 ^{NEW}

Flat cylinder head through-holed screw (hex recessed in one end), zinc plated

- 🇫🇷 Vis à tête cylindrique, avec six pans creux en pointe, en acier zingué
- 🇩🇪 Zylinderkopfschraube (abgeflacht) mit Innensechskant auf der Spitze, verzinkt
- 🇪🇸 Tornillo hueco con cabeza cilíndrica plana, con huella hexagonal por un lado, de acero cincado
- 🇷🇺 Винт с плоской головкой и внутренним шестигранником, шестигранник на одном конце, а затем круглый, оцинкованный



Item code	Socket size M x L (mm)	Pcs. per box	Pcs. per carton
In-Hex (s): 6 mm			
XB 01 12 020	M12 x 20	100	1.000

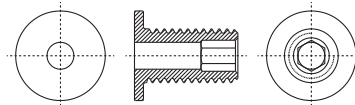

Installation sequence / Instructions de mise en oeuvre / Setzanweisung / Secuencia de instalación / Порядок монтажа

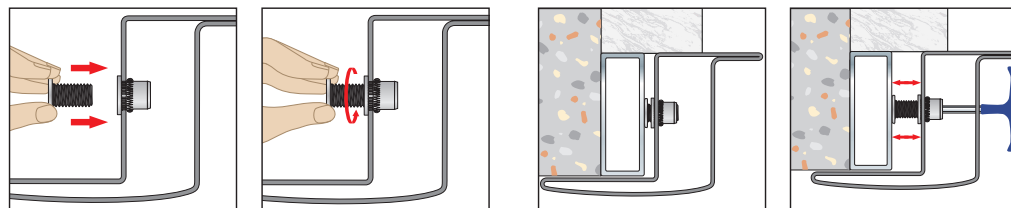

1st step: Drive the screw into the rivet nut (already installed on the frame), taking care to place the head of the screw on the side to be spaced

2nd step: Use the hexagon key wrench to adjust the distance between the window (or door) and the frame



Technical Data Sheet

Box / Boîte / Verpackung
Caja / Упаковка



YT 01 - YTR 01

Knurled open cylindrical shank rivet nut, zinc plated

- Embout fileté, corps cylindrique ouvert moleté, en acier zingué
- Gewindeinsatz, zylinderförmiger Körper gerändelt offen, Stahl verzinkt
- Tuerca remachable grafilada, de acero cincado
- Резьбовая заклепка-гайка из оцинкованной стали с цилиндрическим фланцем

YT 01 dome head / tête cylindrique / Zylinderkopf / cabeza cilíndrica / полукруглый бортик



Technical Data Sheet



Item code	Size <i>M x Ø (foro) x l (mm)</i>	Thickness of fixture <i>t_{fix} min - max (mm)</i>	Head size <i>Ødk x k (mm)</i>	Pcs. per box	Pcs. per carton
YT 01 04 010	M4 x 6 x 10	0,3 - 3	9 x 1	500	5.000
YT 01 04 011	M4 x 6 x 11,5	3 - 4	9 x 1	500	5.000
YT 01 05 012	M5 x 7 x 12	0,3 - 3	10 x 1	500	5.000
YT 01 05 015	M5 x 7 x 15	3 - 4	10 x 1	500	5.000
YT 01 06 014	M6 x 9 x 14,5	0,5 - 3	13 x 1,5	250	2.500
YT 01 06 016	M6 x 9 x 16	3 - 4,5	13 x 1,5	250	2.500
YT 01 08 016	M8 x 11 x 16	0,5 - 3	16 x 1,5	200	2.000
YT 01 08 018	M8 x 11 x 18,5	3 - 5,5	16 x 1,5	200	2.000
YT 01 10 017	M10 x 13 x 17	0,5 - 3	19 x 2	200	2.000
YT 01 10 022	M10 x 13 x 22	3 - 6	19 x 2	100	1.000
YT 01 12 023	M12 x 16 x 23	1 - 4	23 x 2	100	1.000

YTR 01 reduced dome head / Tête cylindrique réduite / reduzierter zylinderkopf / cabeza cilíndrica reducida / полукруглый бортик



Technical Data Sheet



Item code	Size <i>M x Ø (foro) x l (mm)</i>	Thickness of fixture <i>t_{fix} min - max (mm)</i>	Head size <i>Ødk x k (mm)</i>	Pcs. per box	Pcs. per carton
YTR 01 12 020	M12 x 15 x 20	1 - 3,5	19 x 1,8	100	1.000

CK 01

UK Pan head cross recess type H self drilling screw, hardened, zinc plated

FR Vis autoperceuse tête cylindrique, empreinte cruciformes type H, en acier cémenté, zinguée

DE Halbbrundkopf - Bohrschraube Kreuzschlitz H, einsatzgehärtet, verzinkt

ES Tornillo autotaladrante, cabeza cilíndrica cruz tipo H, acero cementado, cincado

RU Оцинкованный самосверлящий шуруп из закаленной стали с цилиндрической скругленной головкой с крестообразным шлицем типа H

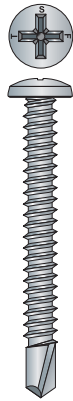

Cross Type H



CrVI Free



inBlister*
p. 487

Usage / Utilisation / Benutzung / Uso / Применение

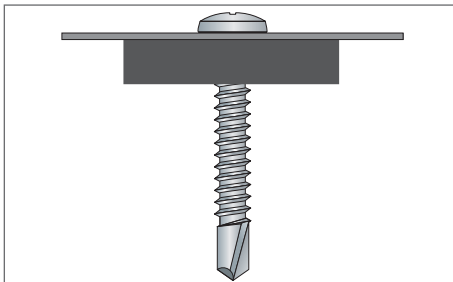

Box / Boîte / Verpackung
Caja / Упаковка



Technical
Data Sheet



Item code	Screw size Ø x L / L ₁ (mm)	T _{fix} (Fixture thickness)		Pcs. per box	Pcs. per carton
		min	max*		
Ø 2,9 / Ph 1					
CK 01 29 009	2,9 x 9,5	0,5	2,5 - t _{fl}	1.000	10.000
CK 01 29 013	2,9 x 13	0,5	6 - t _{fl}	1.000	10.000
CK 01 29 016	2,9 x 16	0,5	9 - t _{fl}	1.000	10.000
CK 01 29 019	2,9 x 19	0,5	12 - t _{fl}	500	5.000
CK 01 29 022	2,9 x 22	0,5	15 - t _{fl}	500	5.000
Ø 3,5 / Ph 2					
CK 01 35 009	3,5 x 9,5	0,5	2,5 - t _{fl}	1.000	10.000
CK 01 35 013	3,5 x 13	0,5	6 - t _{fl}	1.000	10.000
CK 01 35 016	3,5 x 16	0,5	9 - t _{fl}	500	5.000
CK 01 35 019	3,5 x 19	0,5	12 - t _{fl}	500	5.000
CK 01 35 022	3,5 x 22	0,5	15 - t _{fl}	500	5.000
CK 01 35 025	3,5 x 25	0,5	18 - t _{fl}	500	5.000
CK 01 35 032	3,5 x 32	0,5	25 - t _{fl}	500	5.000
Ø 3,9 / Ph 2					
CK 01 39 013	3,9 x 13	0,5	6 - t _{fl}	1.000	10.000
CK 01 39 016	3,9 x 16	0,5	9 - t _{fl}	500	5.000
CK 01 39 019	3,9 x 19	0,5	12 - t _{fl}	500	5.000
CK 01 39 022	3,9 x 22	0,5	15 - t _{fl}	500	5.000
CK 01 39 025	3,9 x 25	0,5	18 - t _{fl}	500	5.000
CK 01 39 032	3,9 x 32	0,5	25 - t _{fl}	500	5.000
CK 01 39 038	3,9 x 38	0,5	31 - t _{fl}	200	2.000
CK 01 39 045	3,9 x 45	0,5	38 - t _{fl}	200	2.000
CK 01 39 050	3,9 x 50	0,5	43 - t _{fl}	200	2.000
Ø 4,2 / Ph 2					
CK 01 42 013	4,2 x 13	0,5	6 - t _{fl}	500	5.000
CK 01 42 016	4,2 x 16	0,5	9 - t _{fl}	500	5.000
CK 01 42 019	4,2 x 19	0,5	12 - t _{fl}	500	5.000
CK 01 42 022	4,2 x 22	0,5	15 - t _{fl}	500	5.000
CK 01 42 025	4,2 x 25	0,5	18 - t _{fl}	500	5.000
CK 01 42 032	4,2 x 32	0,5	25 - t _{fl}	200	2.000
CK 01 42 038	4,2 x 38	0,5	31 - t _{fl}	200	2.000
CK 01 42 045	4,2 x 45	0,5	38 - t _{fl}	200	2.000
Ø 4,8 / Ph 2					
CK 01 48 013	4,8 x 13	0,5	4 - t _{fl}	500	5.000
CK 01 48 016	4,8 x 16	0,5	7 - t _{fl}	500	5.000
CK 01 48 019	4,8 x 19	0,5	10 - t _{fl}	500	5.000
CK 01 48 022	4,8 x 22	0,5	13 - t _{fl}	500	5.000
CK 01 48 025	4,8 x 25	0,5	16 - t _{fl}	200	2.000
CK 01 48 032	4,8 x 32	0,5	23 - t _{fl}	200	2.000
CK 01 48 038	4,8 x 38	0,5	29 - t _{fl}	200	2.000
CK 01 48 045	4,8 x 45	0,5	36 - t _{fl}	200	2.000
CK 01 48 050	4,8 x 50	0,5	41 - t _{fl}	200	2.000
CK 01 48 060	4,8 x 60	0,5	51 - t _{fl}	100	1.000
CK 01 48 070	4,8 x 70 / 60	15	61 - t _{fl}	100	1.000
Ø 5,5 / Ph 3					
CK 01 55 013	5,5 x 13	0,5	3 - t _{fl}	200	2.000
CK 01 55 016	5,5 x 16	0,5	6 - t _{fl}	200	2.000
CK 01 55 019	5,5 x 19	0,5	9 - t _{fl}	200	2.000
CK 01 55 022	5,5 x 22	0,5	12 - t _{fl}	200	2.000
CK 01 55 025	5,5 x 25	0,5	15 - t _{fl}	200	2.000
CK 01 55 032	5,5 x 32	0,5	22 - t _{fl}	200	2.000
CK 01 55 038	5,5 x 38	0,5	28 - t _{fl}	200	2.000
CK 01 55 045	5,5 x 45	0,5	35 - t _{fl}	200	2.000
CK 01 55 050	5,5 x 50	0,5	40 - t _{fl}	200	2.000
CK 01 55 060	5,5 x 60	0,5	50 - t _{fl}	100	1.000
CK 01 55 070	5,5 x 70 / 60	15	60 - t _{fl}	100	1.000
CK 01 55 080	5,5 x 80 / 60	25	70 - t _{fl}	100	1.000
CK 01 55 100	5,5 x 100 / 70	35	90 - t _{fl}	100	1.000

* t_{fl} = thickness of the steel sheet to be drilled / s = épaisseur de la pièce en acier à fixer / s = Dicke des Metallanbauteils wo man befestigt / s = grosor del soporte de metal a fijar / s = толщина закрепляемого металла

CK 03

✚ Pan head cross recess type H self drilling screw, hardened, black zinc plated

🇫🇷 Vis autoperceuse tête cylindrique, empreinte cruciformes type H, en acier cémenté, zinguée noire

🇩🇪 Halbrundkopf - Bohrschraube Kreuzschlitz H, einsatzgehärtet, schwarz verzinkt

🇪🇸 Tornillo autotaladrante, cabeza cilíndrica cruz tipo H, acero cementado, cincado negro

🇷🇺 Оцинкованный самосверлящий шуруп черного цвета из закаленной стали с цилиндрической скругленной головкой с крестообразным шлицем типа H



Item code	Screw size Ø x L / L ₁ (mm)	T _{fix} (Fixture thickness)		Pcs. per box	Pcs. per carton
		min	max*		
Ø 3,5 / Ph 2					
CK 03 35 009	3,5 x 9,5	0,5	2,5 - t _{fl}	1.000	10.000
CK 03 35 013	3,5 x 13	0,5	6 - t _{fl}	1.000	10.000
CK 03 35 016	3,5 x 16	0,5	9 - t _{fl}	500	5.000
CK 03 35 019	3,5 x 19	0,5	12 - t _{fl}	500	5.000
CK 03 35 022	3,5 x 22	0,5	15 - t _{fl}	500	5.000
CK 03 35 025	3,5 x 25	0,5	18 - t _{fl}	500	5.000
Ø 3,9 / Ph 2					
CK 03 39 013	3,9 x 13	0,5	6 - t _{fl}	1.000	10.000
CK 03 39 016	3,9 x 16	0,5	9 - t _{fl}	500	5.000
CK 03 39 019	3,9 x 19	0,5	12 - t _{fl}	500	5.000
CK 03 39 022	3,9 x 22	0,5	15 - t _{fl}	500	5.000
CK 03 39 025	3,9 x 25	0,5	18 - t _{fl}	500	5.000
CK 03 39 032	3,9 x 32	0,5	25 - t _{fl}	500	5.000
Ø 4,2 / Ph 2					
CK 03 42 013	4,2 x 13	0,5	6 - t _{fl}	500	5.000
CK 03 42 016	4,2 x 16	0,5	9 - t _{fl}	500	5.000
CK 03 42 019	4,2 x 19	0,5	12 - t _{fl}	500	5.000
CK 03 42 022	4,2 x 22	0,5	15 - t _{fl}	500	5.000
CK 03 42 025	4,2 x 25	0,5	18 - t _{fl}	500	5.000
CK 03 42 032	4,2 x 32	0,5	25 - t _{fl}	200	2.000
CK 03 42 038	4,2 x 38	0,5	31 - t _{fl}	200	2.000
Ø 4,8 / Ph 2					
CK 03 48 013	4,8 x 13	0,5	4 - t _{fl}	500	5.000
CK 03 48 016	4,8 x 16	0,5	7 - t _{fl}	500	5.000
CK 03 48 019	4,8 x 19	0,5	10 - t _{fl}	500	5.000
CK 03 48 022	4,8 x 22	0,5	13 - t _{fl}	500	5.000
CK 03 48 025	4,8 x 25	0,5	16 - t _{fl}	200	2.000
CK 03 48 032	4,8 x 32	0,5	23 - t _{fl}	200	2.000
CK 03 48 038	4,8 x 38	0,5	29 - t _{fl}	200	2.000
CK 03 48 045	4,8 x 45	0,5	36 - t _{fl}	200	2.000
CK 03 48 050	4,8 x 50	0,5	41 - t _{fl}	200	2.000
CK 03 48 060	4,8 x 60	0,5	51 - t _{fl}	100	1.000
CK 03 48 070	4,8 x 70 / 60	15	61 - t _{fl}	100	1.000

* t_{fl} = thickness of the steel sheet to be drilled / s = épaisseur de la pièce en acier à fixer / s = Dicke des Metallanbauteils wo man befestigt / s = grosor del soporte de metal a fijar / s = товщина закрепляемого металла

Usage / Utilisation / Benutzung / Uso / Применение

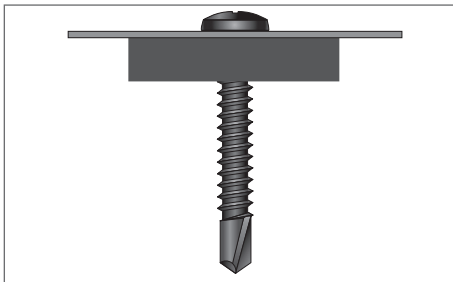

Box / Boîte / Verpackung
Caja / Упаковка



Technical
Data Sheet



RK 01

UK Pan head 6-lobe recess self drilling screw, hardened, zinc plated

FR Vis autoperceuse tête cylindrique, empreinte à six lobes, en acier cémenté, zinguée

DE Halbrundkopf - Bohrschraube Innensechsrund, einsatzgehärtet, verzinkt

ES Tornillo autotaladrante, cabeza cilíndrica 6 lóbulos internos, acero cementado, cincado

RU Оцинкованный самосверлящий шуруп из закаленной стали с цилиндрической скругленной головкой с шестигранным шлицем

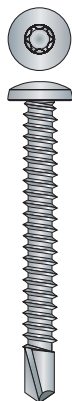

6 lobe

CrVI Free
since 2007

Technical
Data Sheet



Item code	Screw size Ø x L / L ₁ (mm)	Tfix (Fixture thickness)		Pcs. per box	Pcs. per carton
		min	max*		
Ø 2,9 / T-10					
RK 01 29 009	2,9 x 9,5	0,5	2,5 - t _{II}	1.000	10.000
RK 01 29 013	2,9 x 13	0,5	6 - t _{II}	1.000	10.000
RK 01 29 016	2,9 x 16	0,5	9 - t _{II}	500	5.000
RK 01 29 019	2,9 x 19	0,5	12 - t _{II}	500	5.000
RK 01 29 022	2,9 x 22	0,5	15 - t _{II}	500	5.000
Ø 3,5 / T-15					
RK 01 35 009	3,5 x 9,5	0,5	2,5 - t _{II}	1.000	10.000
RK 01 35 013	3,5 x 13	0,5	6 - t _{II}	1.000	10.000
RK 01 35 016	3,5 x 16	0,5	9 - t _{II}	500	5.000
RK 01 35 019	3,5 x 19	0,5	12 - t _{II}	500	5.000
RK 01 35 022	3,5 x 22	0,5	15 - t _{II}	500	5.000
RK 01 35 025	3,5 x 25	0,5	18 - t _{II}	500	5.000
RK 01 35 032	3,5 x 32	0,5	25 - t _{II}	500	5.000
Ø 3,9 / T-15					
RK 01 39 013	3,9 x 13	0,5	6 - t _{II}	1.000	10.000
RK 01 39 016	3,9 x 16	0,5	9 - t _{II}	500	5.000
RK 01 39 019	3,9 x 19	0,5	12 - t _{II}	500	5.000
RK 01 39 022	3,9 x 22	0,5	15 - t _{II}	500	5.000
RK 01 39 025	3,9 x 25	0,5	18 - t _{II}	500	5.000
RK 01 39 032	3,9 x 32	0,5	25 - t _{II}	500	5.000
RK 01 39 038	3,9 x 38	0,5	31 - t _{II}	200	2.000
RK 01 39 045	3,9 x 45	0,5	38 - t _{II}	200	2.000
RK 01 39 050	3,9 x 50	0,5	43 - t _{II}	200	2.000
Ø 4,2 / T-20					
RK 01 42 013	4,2 x 13	0,5	6 - t _{II}	500	5.000
RK 01 42 016	4,2 x 16	0,5	9 - t _{II}	500	5.000
RK 01 42 019	4,2 x 19	0,5	12 - t _{II}	500	5.000
RK 01 42 022	4,2 x 22	0,5	15 - t _{II}	500	5.000
RK 01 42 025	4,2 x 25	0,5	18 - t _{II}	500	5.000
RK 01 42 032	4,2 x 32	0,5	25 - t _{II}	200	2.000
RK 01 42 038	4,2 x 38	0,5	31 - t _{II}	200	2.000
RK 01 42 045	4,2 x 45	0,5	38 - t _{II}	200	2.000
Ø 4,8 / T-25					
RK 01 48 013	4,8 x 13	0,5	4 - t _{II}	500	5.000
RK 01 48 016	4,8 x 16	0,5	7 - t _{II}	500	5.000
RK 01 48 019	4,8 x 19	0,5	10 - t _{II}	500	5.000
RK 01 48 022	4,8 x 22	0,5	13 - t _{II}	500	5.000
RK 01 48 025	4,8 x 25	0,5	16 - t _{II}	200	2.000
RK 01 48 032	4,8 x 32	0,5	23 - t _{II}	200	2.000
RK 01 48 038	4,8 x 38	0,5	29 - t _{II}	200	2.000
RK 01 48 045	4,8 x 45	0,5	36 - t _{II}	200	2.000
RK 01 48 050	4,8 x 50	0,5	41 - t _{II}	200	2.000
RK 01 48 060	4,8 x 60	0,5	51 - t _{II}	100	1.000
RK 01 48 070	4,8 x 70 / 60	15	61 - t _{II}	100	1.000
Ø 5,5 / T-25					
RK 01 55 013	5,5 x 13	0,5	3 - t _{II}	200	2.000
RK 01 55 016	5,5 x 16	0,5	6 - t _{II}	200	2.000
RK 01 55 019	5,5 x 19	0,5	9 - t _{II}	200	2.000
RK 01 55 022	5,5 x 22	0,5	12 - t _{II}	200	2.000
RK 01 55 025	5,5 x 25	0,5	15 - t _{II}	200	2.000
RK 01 55 032	5,5 x 32	0,5	22 - t _{II}	200	2.000
RK 01 55 038	5,5 x 38	0,5	28 - t _{II}	200	2.000
RK 01 55 045	5,5 x 45	0,5	35 - t _{II}	200	2.000
RK 01 55 050	5,5 x 50	0,5	40 - t _{II}	200	2.000
RK 01 55 060	5,5 x 60	0,5	50 - t _{II}	100	1.000
RK 01 55 070	5,5 x 70 / 60	15	60 - t _{II}	100	1.000
RK 01 55 080	5,5 x 80 / 60	25	70 - t _{II}	100	1.000
RK 01 55 100	5,5 x 100 / 70	35	90 - t _{II}	100	1.000

>>>

RK 01

🇬🇧 Pan head 6-lobe recess self drilling screw, hardened, zinc plated

🇫🇷 Vis autoperceuse tête cylindrique, empreinte à six lobes, en acier cémenté, zinguée

🇩🇪 Halbrundkopf - Bohrschraube Innensechsrund, einsatzgehärtet, verzinkt

🇪🇸 Tornillo autotaladrante, cabeza cilíndrica 6 lóbulos internos, acero cementado, cincado

🇷🇺 Оцинкованный самосверлящий шуруп из закаленной стали с цилиндрической скругленной головкой с шестигранным шлицем

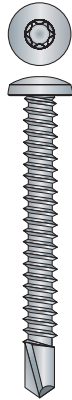

Item code	Screw size Ø x L / L ₁ (mm)	T _{fix} (Fixture thickness)		Pcs. per box	Pcs. per carton
		min	max*		
Ø 6,3 / T-30					
🇬🇧🇫🇷🇩🇪🇪🇸🇷🇺 RK 01 63 016	6,3 x 16	0,5	4 - t _{II}	200	2.000
🇬🇧🇫🇷🇩🇪🇪🇸🇷🇺 RK 01 63 019	6,3 x 19	0,5	7 - t _{II}	200	2.000
🇬🇧🇫🇷🇩🇪🇪🇸🇷🇺 RK 01 63 022	6,3 x 22	0,5	10 - t _{II}	200	2.000
🇬🇧🇫🇷🇩🇪🇪🇸🇷🇺 RK 01 63 025	6,3 x 25	0,5	13 - t _{II}	200	2.000
🇬🇧🇫🇷🇩🇪🇪🇸🇷🇺 RK 01 63 032	6,3 x 32	0,5	20 - t _{II}	200	2.000
🇬🇧🇫🇷🇩🇪🇪🇸🇷🇺 RK 01 63 038	6,3 x 38	0,5	26 - t _{II}	200	2.000
🇬🇧🇫🇷🇩🇪🇪🇸🇷🇺 RK 01 63 050	6,3 x 50	0,5	38 - t _{II}	200	2.000
🇬🇧🇫🇷🇩🇪🇪🇸🇷🇺 RK 01 63 060	6,3 x 60	0,5	48 - t _{II}	100	1.000
🇬🇧🇫🇷🇩🇪🇪🇸🇷🇺 RK 01 63 070	6,3 x 70 / 60	15	58 - t _{II}	100	1.000
🇬🇧🇫🇷🇩🇪🇪🇸🇷🇺 RK 01 63 080	6,3 x 80 / 60	25	68 - t _{II}	100	1.000
🇬🇧🇫🇷🇩🇪🇪🇸🇷🇺 RK 01 63 100	6,3 x 100 / 70	35	88 - t _{II}	100	1.000
🇬🇧🇫🇷🇩🇪🇪🇸🇷🇺 RK 01 63 120	6,3 x 120 / 70	55	108 - t _{II}	100	1.000
🇬🇧🇫🇷🇩🇪🇪🇸🇷🇺 RK 01 63 140	6,3 x 140 / 70	75	128 - t _{II}	100	1.000

* t_{II} = thickness of the steel sheet to be drilled / s = épaisseur de la pièce en acier à fixer / s = Dicke des Metallanbauteils wo man befestigt / s = grosor del soporte de metal a fijar / s = толщина закрепляемого металла

🇬🇧🇫🇷🇩🇪🇪🇸🇷🇺 ETA-CE Certified item / Agrément technique européen ETE-CE / ETA-CE Zulassung / Homologación ETA-CE / Сертификация ETA-CE

🇬🇧🇫🇷🇩🇪🇪🇸🇷🇺 Fire Reaction A1 / Réaction au feu A1 / Brandverhalten A1 / Reacción al fuego A1 / Реакция на огонь A1



6 lobe



CrVI Free



DoP



Declaration of Performance

European Technical Assessment
EAD 330047-01-0602

Usage / Utilisation / Benutzung / Uso / Применение

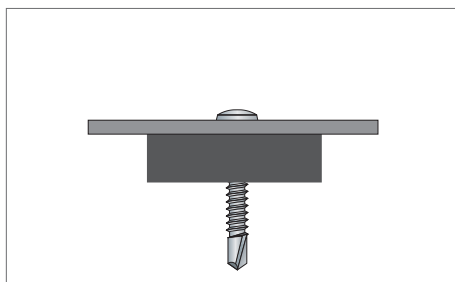

One bit free per box



🇬🇧 one bit free per box

🇫🇷 Un embout gratuit dans chaque boîte

🇩🇪 Zu jeder Verpackung ein Bit kostenlos

🇪🇸 Una punta de atornillar en cada caja

🇷🇺 Один бесплатный бит в каждой упаковке

Box / Boîte / Verpackung / Caja / Упаковка

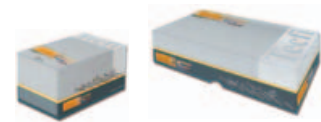

CH 01

Flat csk head cross recess type H self drilling screw, hardened, zinc plated

Vis autoperceuse tête fraisée plate, empreinte cruciformes type H, en acier cémenté, zinguée

Senkkopf-Bohrschraube Kreuzschlitz H, einsatzgehärtet

Tornillo autotaladrante, cabeza avellanada cruz tipo H, acero cementado, cincado

Оцинкованный самосверлящий шуруп из закаленной стали с плоской потайной головкой с крестообразным шлицем типа H

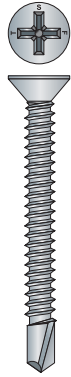

Cross Type H

CrVI Free

inBlister®
p. 487

Usage / Utilisation / Benutzung / Uso / Применение

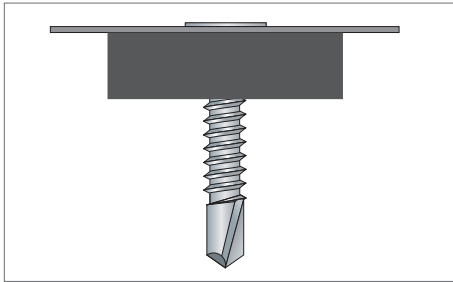

Box / Boîte / Verpackung
Caja / Упаковка



Technical
Data Sheet



Item code	Screw size Ø x L / L ₁ (mm)	Tfix (Fixture thickness)		Pcs. per box	Pcs. per carton
		min	max*		
Ø 2,9 / Ph 1					
CH 01 29 009	2,9 x 9,5	2,5	3,5 - t _{II}	1.000	10.000
CH 01 29 013	2,9 x 13	2,5	5 - t _{II}	1.000	10.000
CH 01 29 016	2,9 x 16	2,5	8 - t _{II}	1.000	10.000
CH 01 29 019	2,9 x 19	2,5	11 - t _{II}	500	5.000
CH 01 29 022	2,9 x 22	2,5	14 - t _{II}	500	5.000
Ø 3,5 / Ph 2					
CH 01 35 009	3,5 x 9,5	2,5	3 - t _{II}	1.000	10.000
CH 01 35 013	3,5 x 13	2,5	6 - t _{II}	1.000	10.000
CH 01 35 016	3,5 x 16	2,5	9 - t _{II}	500	5.000
CH 01 35 019	3,5 x 19	2,5	12 - t _{II}	500	5.000
CH 01 35 022	3,5 x 22	2,5	15 - t _{II}	500	5.000
CH 01 35 025	3,5 x 25	2,5	18 - t _{II}	500	5.000
CH 01 35 032	3,5 x 32	2,5	25 - t _{II}	500	5.000
CH 01 35 038	3,5 x 38	2,5	31 - t _{II}	500	5.000
Ø 3,9 / Ph 2					
CH 01 39 013	3,9 x 13	3	5 - t _{II}	1.000	10.000
CH 01 39 016	3,9 x 16	3	8 - t _{II}	500	5.000
CH 01 39 019	3,9 x 19	3	11 - t _{II}	500	5.000
CH 01 39 022	3,9 x 22	3	14 - t _{II}	500	5.000
CH 01 39 025	3,9 x 25	3	17 - t _{II}	500	5.000
CH 01 39 032	3,9 x 32	3	24 - t _{II}	500	5.000
CH 01 39 038	3,9 x 38	3	30 - t _{II}	200	2.000
CH 01 39 045	3,9 x 45	3	37 - t _{II}	200	2.000
CH 01 39 050	3,9 x 50	3	42 - t _{II}	200	2.000
Ø 4,2 / Ph 2					
CH 01 42 013	4,2 x 13	3	4 - t _{II}	500	5.000
CH 01 42 016	4,2 x 16	3	7 - t _{II}	500	5.000
CH 01 42 019	4,2 x 19	3	10 - t _{II}	500	5.000
CH 01 42 022	4,2 x 22	3	13 - t _{II}	500	5.000
CH 01 42 025	4,2 x 25	3	16 - t _{II}	500	5.000
CH 01 42 032	4,2 x 32	3	23 - t _{II}	200	2.000
CH 01 42 038	4,2 x 38	3	29 - t _{II}	200	2.000
CH 01 42 045	4,2 x 45	3	36 - t _{II}	200	2.000
CH 01 42 050	4,2 x 50	3	41 - t _{II}	200	2.000
Ø 4,8 / Ph 2					
CH 01 48 016	4,8 x 16	3,5	5 - t _{II}	500	5.000
CH 01 48 019	4,8 x 19	3,5	8 - t _{II}	500	5.000
CH 01 48 022	4,8 x 22	3,5	11 - t _{II}	500	5.000
CH 01 48 025	4,8 x 25	3,5	14 - t _{II}	500	5.000
CH 01 48 032	4,8 x 32	3,5	21 - t _{II}	200	2.000
CH 01 48 038	4,8 x 38	3,5	27 - t _{II}	200	2.000
CH 01 48 045	4,8 x 45	3,5	34 - t _{II}	200	2.000
CH 01 48 050	4,8 x 50	3,5	39 - t _{II}	200	2.000
CH 01 48 060	4,8 x 60	3,5	49 - t _{II}	100	1.000
CH 01 48 070	4,8 x 70 / 60	10	59 - t _{II}	100	1.000
Ø 5,5 / Ph 3					
CH 01 55 019	5,5 x 19	4	7 - t _{II}	200	2.000
CH 01 55 022	5,5 x 22	4	10 - t _{II}	200	2.000
CH 01 55 025	5,5 x 25	4	13 - t _{II}	200	2.000
CH 01 55 032	5,5 x 32	4	20 - t _{II}	200	2.000
CH 01 55 038	5,5 x 38	4	26 - t _{II}	200	2.000
CH 01 55 045	5,5 x 45	4	33 - t _{II}	200	2.000
CH 01 55 050	5,5 x 50	4	38 - t _{II}	200	2.000
CH 01 55 060	5,5 x 60	4	48 - t _{II}	100	1.000
CH 01 55 070	5,5 x 70 / 60	10	58 - t _{II}	100	1.000
CH 01 55 080	5,5 x 80 / 60	20	68 - t _{II}	100	1.000
CH 01 55 100	5,5 x 100 / 70	30	88 - t _{II}	100	1.000

* t_{II} = thickness of the steel sheet to be drilled / s = épaisseur de la pièce en acier à fixer / s = Dicke des Metallanbauteils wo man befestigt / s = grosor del soporte de metal a fijar / s = толщина закрепляемого металла

CH 03

Flat csk head cross recess type H self drilling screw, hardened, black zinc plated

Vis autoperceuse tête fraisée plate, empreinte cruciformes type H, en acier cémenté, zinguée noire

Senkkopf-Bohrschraube Kreuzschlitz H, einsatzgehärtet, schwarz verzinkt

Tornillo autotaladrante, cabeza avellanada cruz tipo H, acero cementado, cincado negro

Оцинкованный черного цвета самосверлящий шуруп из закаленной стали с плоской потайной головкой с крестообразным шлицем типа H



Cross Type H



Item code	Screw size Ø x L / L ₁ (mm)	T _{fix} (Fixture thickness)		Pcs. per box	Pcs. per carton
		min	max*		
Ø 3,5 / Ph 2					
CH 03 35 013	3,5 x 13	2,5	6 - t _{II}	1.000	10.000
CH 03 35 016	3,5 x 16	2,5	9 - t _{II}	500	5.000
CH 03 35 019	3,5 x 19	2,5	12 - t _{II}	500	5.000
CH 03 35 022	3,5 x 22	2,5	15 - t _{II}	500	5.000
CH 03 35 025	3,5 x 25	2,5	18 - t _{II}	500	5.000
Ø 3,9 / Ph 2					
CH 03 39 013	3,9 x 13	3	5 - t _{II}	1.000	10.000
CH 03 39 016	3,9 x 16	3	8 - t _{II}	500	5.000
CH 03 39 019	3,9 x 19	3	11 - t _{II}	500	5.000
CH 03 39 022	3,9 x 22	3	14 - t _{II}	500	5.000
CH 03 39 025	3,9 x 25	3	17 - t _{II}	500	5.000
CH 03 39 032	3,9 x 32	3	24 - t _{II}	500	5.000
Ø 4,2 / Ph 2					
CH 03 42 013	4,2 x 13	3	4 - t _{II}	500	5.000
CH 03 42 016	4,2 x 16	3	7 - t _{II}	500	5.000
CH 03 42 019	4,2 x 19	3	10 - t _{II}	500	5.000
CH 03 42 022	4,2 x 22	3	13 - t _{II}	500	5.000
CH 03 42 025	4,2 x 25	3	16 - t _{II}	500	5.000
CH 03 42 032	4,2 x 32	3	23 - t _{II}	200	2.000
CH 03 42 038	4,2 x 38	3	29 - t _{II}	200	2.000
Ø 4,8 / Ph 2					
CH 03 48 016	4,8 x 16	3,5	5 - t _{II}	500	5.000
CH 03 48 019	4,8 x 19	3,5	8 - t _{II}	500	5.000
CH 03 48 022	4,8 x 22	3,5	11 - t _{II}	500	5.000
CH 03 48 025	4,8 x 25	3,5	14 - t _{II}	500	5.000
CH 03 48 032	4,8 x 32	3,5	21 - t _{II}	200	2.000
CH 03 48 038	4,8 x 38	3,5	27 - t _{II}	200	2.000
CH 03 48 045	4,8 x 45	3,5	34 - t _{II}	200	2.000
CH 03 48 050	4,8 x 50	3,5	39 - t _{II}	200	2.000
CH 03 48 060	4,8 x 60	3,5	49 - t _{II}	100	1.000
CH 03 48 070	4,8 x 70 / 60	10	59 - t _{II}	100	1.000
Ø 6,3 / Ph 3					
CH 03 63 050	6,3 x 50	4	38 - t _{II}	200	2.000

* t_{II} = thickness of the steel sheet to be drilled / s = épaisseur de la pièce en acier à fixer / s = Dicke des Metallanbauteils wo man befestigt / s = grosor del soporte de metal a fijar / s = толщина закрепляемого металла

Usage / Utilisation / Benutzung / Uso / Применение

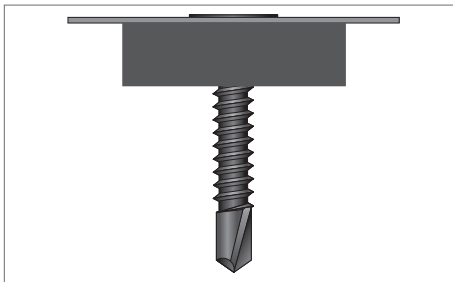

Box / Boîte / Verpackung
Caja / Упаковка



Technical
Data Sheet



RH 01

Flat csk head 6-lobe recess self drilling screw, hardened, zinc plated

Vis autoperceuse tête fraisée plate, empreinte à six lobes, en acier cémenté, zinguée

Senkkopf-Bohrschraube Innensechsrund, einsatzgehärtet, verzinkt

Tornillo autotaladrante, cabeza avellanada 6 lóbulos internos, acero cementado, cincado

Оцинкованный самосверлящий шуруп из закаленной стали с плоской потайной головкой с шестигранным шлицем

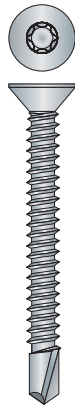

European Technical Assessment
EAD 330047-01-0602

Usage / Utilisation / Benutzung / Uso / Применение

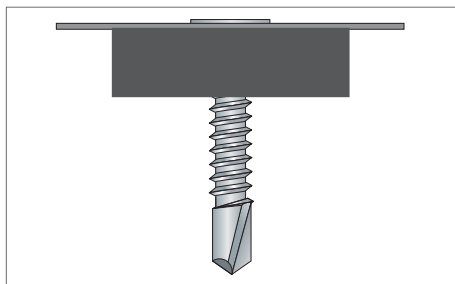

Box / Boîte / Verpackung
Caja / Упаковка



DoP



One bit free per box



one bit free per box

Un embout gratuit dans chaque boîte

Zu jeder Verpackung ein Bit kostenlos

Una punta de atornillar en cada caja

Один бесплатный бит в каждой упаковке

Item code	Screw size Ø x L / L ₁ (mm)	Tfix (Fixture thickness)		Pcs. per box	Pcs. per carton
		min	max*		
Ø 2,9 / T-10					
RH 01 29 009	2,9 x 9,5	2	2,5 - t _{II}	1.000	10.000
RH 01 29 013	2,9 x 13	2	6 - t _{II}	1.000	10.000
RH 01 29 016	2,9 x 16	2	9 - t _{II}	500	5.000
RH 01 29 019	2,9 x 19	2	12 - t _{II}	500	5.000
Ø 3,5 / T-15					
RH 01 35 013	3,5 x 13	2,5	5 - t _{II}	1.000	10.000
RH 01 35 016	3,5 x 16	2,5	8 - t _{II}	500	5.000
RH 01 35 019	3,5 x 19	2,5	11 - t _{II}	500	5.000
RH 01 35 022	3,5 x 22	2,5	14 - t _{II}	500	5.000
RH 01 35 025	3,5 x 25	2,5	17 - t _{II}	500	5.000
RH 01 35 032	3,5 x 32	2,5	24 - t _{II}	500	5.000
RH 01 35 038	3,5 x 38	2,5	30 - t _{II}	500	5.000
Ø 3,9 / T-15					
RH 01 39 013	3,9 x 13	3	5 - t _{II}	1.000	10.000
RH 01 39 016	3,9 x 16	3	8 - t _{II}	500	5.000
RH 01 39 019	3,9 x 19	3	11 - t _{II}	500	5.000
RH 01 39 022	3,9 x 22	3	14 - t _{II}	500	5.000
RH 01 39 025	3,9 x 25	3	17 - t _{II}	500	5.000
RH 01 39 032	3,9 x 32	3	24 - t _{II}	500	5.000
RH 01 39 038	3,9 x 38	3	30 - t _{II}	200	2.000
RH 01 39 045	3,9 x 45	3	37 - t _{II}	200	2.000
RH 01 39 050	3,9 x 50	3	42 - t _{II}	200	2.000
Ø 4,2 / T-20					
RH 01 42 013	4,2 x 13	3	5 - t _{II}	500	5.000
RH 01 42 016	4,2 x 16	3	8 - t _{II}	500	5.000
RH 01 42 019	4,2 x 19	3	11 - t _{II}	500	5.000
RH 01 42 022	4,2 x 22	3	14 - t _{II}	500	5.000
RH 01 42 025	4,2 x 25	3	17 - t _{II}	500	5.000
RH 01 42 032	4,2 x 32	3	24 - t _{II}	200	2.000
RH 01 42 038	4,2 x 38	3	30 - t _{II}	200	2.000
RH 01 42 045	4,2 x 45	3	37 - t _{II}	200	2.000
RH 01 42 050	4,2 x 50	3	42 - t _{II}	200	2.000
Ø 4,8 / T-25					
RH 01 48 016	4,8 x 16	3,5	7 - t _{II}	500	5.000
RH 01 48 019	4,8 x 19	3,5	10 - t _{II}	500	5.000
RH 01 48 022	4,8 x 22	3,5	13 - t _{II}	500	5.000
RH 01 48 025	4,8 x 25	3,5	16 - t _{II}	500	5.000
RH 01 48 032	4,8 x 32	3,5	23 - t _{II}	200	2.000
RH 01 48 038	4,8 x 38	3,5	29 - t _{II}	200	2.000
RH 01 48 045	4,8 x 45	3,5	36 - t _{II}	200	2.000
RH 01 48 050	4,8 x 50	3,5	41 - t _{II}	200	2.000
RH 01 48 060	4,8 x 60	3,5	51 - t _{II}	100	1.000
RH 01 48 070	4,8 x 70 / 60	10	61 - t _{II}	100	1.000
Ø 5,5 / T-25					
RH 01 55 019	5,5 x 19	4	9 - t _{II}	200	2.000
RH 01 55 022	5,5 x 22	4	12 - t _{II}	200	2.000
RH 01 55 025	5,5 x 25	4	15 - t _{II}	200	2.000
RH 01 55 032	5,5 x 32	4	22 - t _{II}	200	2.000
RH 01 55 038	5,5 x 38	4	28 - t _{II}	200	2.000
RH 01 55 045	5,5 x 45	4	35 - t _{II}	200	2.000
RH 01 55 050	5,5 x 50	4	40 - t _{II}	200	2.000
RH 01 55 060	5,5 x 60	4	50 - t _{II}	100	1.000
RH 01 55 070	5,5 x 70 / 60	15	60 - t _{II}	100	1.000
RH 01 55 080	5,5 x 80 / 60	25	70 - t _{II}	100	1.000
RH 01 55 100	5,5 x 100 / 70	35	90 - t _{II}	100	1.000
Ø 6,3 / T-30					
RH 01 63 016	6,3 x 16	4,5	6 - t _{II}	200	2.000
RH 01 63 019	6,3 x 19	4,5	7 - t _{II}	200	2.000
RH 01 63 022	6,3 x 22	4,5	10 - t _{II}	200	2.000
RH 01 63 025	6,3 x 25	4,5	13 - t _{II}	200	2.000
RH 01 63 032	6,3 x 32	4,5	20 - t _{II}	200	2.000
RH 01 63 038	6,3 x 38	4,5	26 - t _{II}	200	2.000
RH 01 63 050	6,3 x 50	4,5	38 - t _{II}	200	2.000
RH 01 63 060	6,3 x 60	4,5	48 - t _{II}	100	1.000
RH 01 63 070	6,3 x 70 / 60	15	58 - t _{II}	100	1.000
RH 01 63 080	6,3 x 80 / 60	25	68 - t _{II}	100	1.000
RH 01 63 100	6,3 x 100 / 70	35	88 - t _{II}	100	1.000
RH 01 63 120	6,3 x 120 / 70	55	108 - t _{II}	100	1.000
RH 01 63 140	6,3 x 140 / 70	75	128 - t _{II}	100	1.000



Until stockout / Jusqu'à épuisement de stocks / Jusqu'à épuisement de stocks / Solange der Vorrat reicht / Hasta agotar existencias / до окончания стока

* t_{II} = thickness of the steel sheet to be drilled / s = épaisseur de la pièce en acier à fixer / s = Dicke des Metallanbauteils wo man befestigt / s = grosor del soporte de metal a fijar / s = толщина закрепляемого металла

ETA-CE Certified item / Agrément technique européen ETE-CE / ETA-CE Zulassung / Homologación ETA-CE / Сертификация ETA-CE

Fire Reaction A1 / Réaction au feu A1 / Brandverhalten A1 / Reacción al fuego A1 / Реакция на огонь A1

HZ 01

Flat csk head with ribs 6-lobe recess self drilling screw with wings, hardened, zinc plated

Vis autoperceuse tête fraisée plate avec bossage et ailettes, empreinte à six lobes, en acier cémenté, zinguée

Senkkopf-Bohrschraube mit Fräsrippen und Flügel, Innensechsrund, einsatzgehärtet, verzinkt

Tornillo autotaladrante, cabeza avellanada 6 lóbulos internos con estrías bloqueadoras, con alas, acero cementado, cincado

Оцинкованный самосверлящий шуруп из закаленной стали с плоской потайной головкой с насечками с шестигранным шлицем и со специальными крылышками

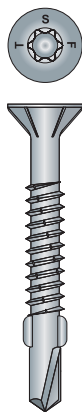

6 lobe



CrVI Free since 2008

Item code	Screw size Ø x L / L ₁ (mm)	T _{fix} (Fixture thickness)		Pcs. per box	Pcs. per carton
		min	max*		
Ø 4,2 / T-25 / Drilling capacity: max 3 mm					
HZ 01 42 032	4,2 x 32	5	20 - t _{II}	200	2.000
HZ 01 42 045	4,2 x 45	10	33 - t _{II}	200	2.000
Ø 4,8 / T-25 / Drilling capacity: max 4 mm					
HZ 01 48 038	4,8 x 38	4,5	25 - t _{II}	200	2.000
HZ 01 48 045	4,8 x 45	4,5	32 - t _{II}	200	2.000
HZ 01 48 060	4,8 x 60	4,5	47 - t _{II}	100	1.000
HZ 01 48 070	4,8 x 70 / 60	10	57 - t _{II}	100	1.000
HZ 01 48 080	4,8 x 80 / 60	20	67 - t _{II}	100	1.000
HZ 01 48 100	4,8 x 100 / 70	30	87 - t _{II}	100	1.000
Ø 5,5 / T-30 / Drilling capacity: max 5 mm					
HZ 01 55 038	5,5 x 38	6	24 - t _{II}	200	2.000
HZ 01 55 045	5,5 x 45	6	31 - t _{II}	200	2.000
HZ 01 55 050	5,5 x 50	6	36 - t _{II}	200	2.000
HZ 01 55 060	5,5 x 60	6	46 - t _{II}	100	1.000
HZ 01 55 070	5,5 x 70 / 60	10	56 - t _{II}	100	1.000
HZ 01 55 080	5,5 x 80 / 60	20	66 - t _{II}	100	1.000
HZ 01 55 100	5,5 x 100 / 70	30	86 - t _{II}	100	1.000
Ø 6,3 / T-30 / Drilling capacity: max 8 mm					
HZ 01 63 040	6,3 x 40	6	21 - t _{II}	200	2.000
HZ 01 63 050	6,3 x 50	6	31 - t _{II}	200	2.000
HZ 01 63 055	6,3 x 55	6	36 - t _{II}	200	2.000
HZ 01 63 060	6,3 x 60	6	41 - t _{II}	100	1.000
HZ 01 63 065	6,3 x 65	6	46 - t _{II}	100	1.000
HZ 01 63 070	6,3 x 70 / 60	10	51 - t _{II}	100	1.000
HZ 01 63 080	6,3 x 80 / 60	20	61 - t _{II}	100	1.000
HZ 01 63 100	6,3 x 100 / 70	30	81 - t _{II}	100	1.000
HZ 01 63 120	6,3 x 120 / 70	50	101 - t _{II}	100	1.000

Usage / Utilisation / Benutzung / Uso / Применение

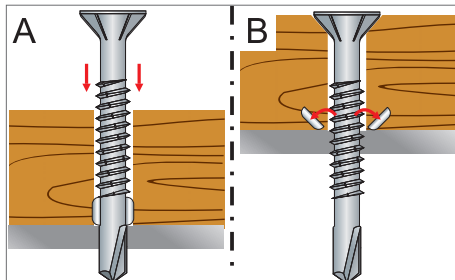

For wooden panels fixing on metal supports predrill is not required.

Box / Boîte / Verpackung
Caja / Упаковка



Technical
Data Sheet



LK 01

UK Pan head cross recess type H tapping screw, hardened, zinc plated

FR Vis autotaraudeuse tête cylindrique empreinte cruciforme Type H, en acier cémenté, zinguée

DE Halbrundkopf - Blechschraube, Kreuzschlitz H, einsatzgehärtet, verzinkt

ES Tornillo autorroscante, cabeza cilíndrica cruz tipo H, acero cementado, cincado

RU Оцинкованный шуруп-саморез из закаленной стали с цилиндрической скругленной головкой с крестообразным шлицем типа H

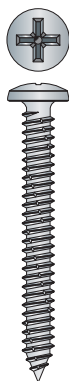

Cross Type H



CrVI Free



inBlister®

p. 486

Item code	Screw size Ø x L / L ₁ (mm)	Pcs. per box	Pcs. per carton
Ø 2,2 / Ph 1			
LK 01 22 006	2,2 x 6,5	1.000	10.000
LK 01 22 009	2,2 x 9,5	1.000	10.000
LK 01 22 013	2,2 x 13	1.000	10.000
LK 01 22 016	2,2 x 16	1.000	10.000
Ø 2,9 / Ph 1			
LK 01 29 006	2,9 x 6,5	1.000	10.000
LK 01 29 009	2,9 x 9,5	1.000	10.000
LK 01 29 013	2,9 x 13	1.000	10.000
LK 01 29 016	2,9 x 16	500	5.000
LK 01 29 019	2,9 x 19	500	5.000
LK 01 29 022	2,9 x 22	500	5.000
LK 01 29 025	2,9 x 25	500	5.000
LK 01 29 032	2,9 x 32	500	5.000
Ø 3,5 / Ph 2			
LK 01 35 006	3,5 x 6,5	1.000	10.000
IN LK 01 35 009	3,5 x 9,5	1.000	10.000
IN LK 01 35 013	3,5 x 13	1.000	10.000
IN LK 01 35 016	3,5 x 16	500	5.000
IN LK 01 35 019	3,5 x 19	500	5.000
IN LK 01 35 022	3,5 x 22	500	5.000
IN LK 01 35 025	3,5 x 25	500	5.000
IN LK 01 35 032	3,5 x 32	500	5.000
LK 01 35 038	3,5 x 38	500	5.000
LK 01 35 045	3,5 x 45	200	2.000
LK 01 35 050	3,5 x 50	200	2.000
Ø 3,9 / Ph 2			
LK 01 39 006	3,9 x 6,5	1.000	10.000
LK 01 39 009	3,9 x 9,5	1.000	10.000
LK 01 39 013	3,9 x 13	1.000	10.000
IN LK 01 39 016	3,9 x 16	500	5.000
IN LK 01 39 019	3,9 x 19	500	5.000
IN LK 01 39 022	3,9 x 22	500	5.000
IN LK 01 39 025	3,9 x 25	500	5.000
IN LK 01 39 032	3,9 x 32	500	5.000
IN LK 01 39 038	3,9 x 38	200	2.000
LK 01 39 045	3,9 x 45	200	2.000
LK 01 39 050	3,9 x 50	200	2.000
Ø 4,2 / Ph 2			
LK 01 42 009	4,2 x 9,5	500	5.000
LK 01 42 013	4,2 x 13	500	5.000
LK 01 42 016	4,2 x 16	500	5.000
IN LK 01 42 019	4,2 x 19	500	5.000
IN LK 01 42 022	4,2 x 22	500	5.000
IN LK 01 42 025	4,2 x 25	500	5.000
IN LK 01 42 032	4,2 x 32	200	2.000
IN LK 01 42 038	4,2 x 38	200	2.000
IN LK 01 42 045	4,2 x 45	200	2.000
LK 01 42 050	4,2 x 50	200	2.000
LK 01 42 060	4,2 x 60	200	2.000
LK 01 42 070	4,2 x 70 / 60	200	2.000

>>>

LK 01

✚ Pan head cross recess type H tapping screw, hardened, zinc plated

🇫🇷 Vis autotaraudeuse tête cylindrique empreinte cruciforme Type H, en acier cémenté, zinguée

🇩🇪 Halbbrundkopf - Blechschraube, Kreuzschlitz H, einsatzgehärtet, verzinkt

🇮🇹 Tornillo autorroscante, cabeza cilíndrica cruz tipo H, acero cementado, cincado

🇷🇺 Оцинкованный шуруп-саморез из закаленной стали с цилиндрической скругленной головкой с крестообразным шлицем типа H

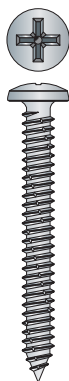

Item code	Screw size Ø x L / L ₁ (mm)	Pcs. per box	Pcs. per carton
Ø 4,8 / Ph 2			
LK 01 48 009	4,8 x 9,5	500	5.000
LK 01 48 013	4,8 x 13	500	5.000
in LK 01 48 016	4,8 x 16	500	5.000
in LK 01 48 019	4,8 x 19	500	5.000
in LK 01 48 022	4,8 x 22	500	5.000
in LK 01 48 025	4,8 x 25	500	5.000
in LK 01 48 032	4,8 x 32	200	2.000
in LK 01 48 038	4,8 x 38	200	2.000
in LK 01 48 045	4,8 x 45	200	2.000
in LK 01 48 050	4,8 x 50	200	2.000
LK 01 48 060	4,8 x 60	100	1.000
LK 01 48 070	4,8 x 70 / 60	100	1.000
LK 01 48 080	4,8 x 80 / 60	100	1.000
LK 01 48 100	4,8 x 100 / 60	100	1.000
LK 01 48 120	4,8 x 120 / 60	100	1.000
Ø 5,5 / Ph 3			
LK 01 55 013	5,5 x 13	200	2.000
LK 01 55 016	5,5 x 16	200	2.000
LK 01 55 019	5,5 x 19	200	2.000
LK 01 55 022	5,5 x 22	200	2.000
in LK 01 55 025	5,5 x 25	200	2.000
in LK 01 55 032	5,5 x 32	200	2.000
in LK 01 55 038	5,5 x 38	200	2.000
in LK 01 55 045	5,5 x 45	200	2.000
in LK 01 55 050	5,5 x 50	200	2.000
LK 01 55 060	5,5 x 60	100	1.000
LK 01 55 070	5,5 x 70 / 60	100	1.000
LK 01 55 080	5,5 x 80 / 60	100	1.000
LK 01 55 100	5,5 x 100 / 60	100	1.000
LK 01 55 120	5,5 x 120 / 60	100	1.000
Ø 6,3 / Ph 3			
LK 01 63 016	6,3 x 16	200	2.000
LK 01 63 019	6,3 x 19	200	2.000
LK 01 63 022	6,3 x 22	200	2.000
LK 01 63 025	6,3 x 25	200	2.000
in LK 01 63 032	6,3 x 32	200	2.000
in LK 01 63 038	6,3 x 38	200	2.000
LK 01 63 045	6,3 x 45	200	2.000
in LK 01 63 050	6,3 x 50	200	2.000
LK 01 63 060	6,3 x 60	100	1.000
LK 01 63 070	6,3 x 70 / 60	100	1.000
LK 01 63 080	6,3 x 80 / 60	100	1.000
LK 01 63 100	6,3 x 100 / 60	100	1.000

Usage / Utilisation / Benutzung / Uso / Применение

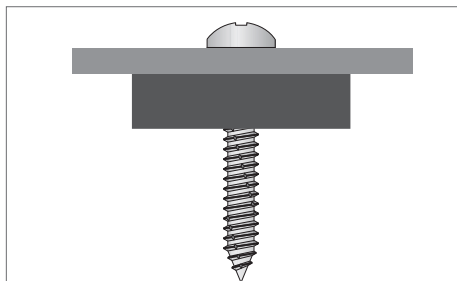

Pre-drill holes, see p. 84 / Trous de préparation, voir p. 84 /
Vorbereitungslöcher, siehe p. 84 / Pretaladros, consulte p. 84 /
Предварительное сверление, p. 84

Box / Boîte / Verpackung Caja / Упаковка



Technical Data Sheet



LH 01

Flat csk head cross recess type H tapping screw, hardened

Vis autotaraudeuse tête fraisée plate empreinte cruciforme Type H, en acier cémenté

Senkkopf- Blechschaube, Kreuzschlitz H, einsatzgehärtet

Tornillo autorroscante, cabeza avellanada cruz tipo H, acero cementado

Оцинкованный шуруп-саморез из закаленной стали с плоской потайной головкой с крестообразным шлицем типа H

LH 01 zinc plated / zinguée / verzinkt / cincado / Оцинкованный



Usage / Utilisation / Benutzung / Uso / Применение

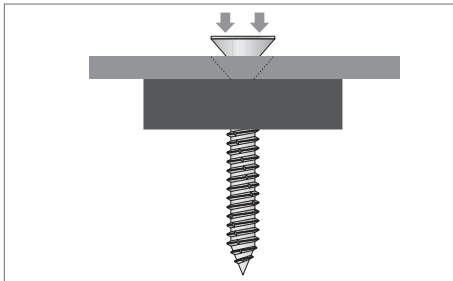

Pre-drill holes, see p. 84 / Trous de préparation, voir p. 84 /
Vorbereitungslöcher, siehe p. 84 / Pretaladros, consulte p. 84 /
Предварительное сверление, p. 84

Technical Data Sheet



Box / Boîte / Verpackung / Caja / Упаковка

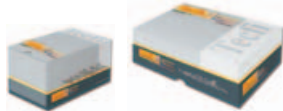

Item code	Screw size Ø x L / L ₁ (mm)	Pcs. per box	Pcs. per carton
Ø 2,2 / Ph 1			
LH 01 22 006	2,2 x 6,5	1.000	10.000
LH 01 22 009	2,2 x 9,5	1.000	10.000
LH 01 22 013	2,2 x 13	1.000	10.000
LH 01 22 016	2,2 x 16	1.000	10.000
LH 01 22 019	2,2 x 19	1.000	10.000
Ø 2,9 / Ph 1			
LH 01 29 006	2,9 x 6,5	1.000	10.000
LH 01 29 009	2,9 x 9,5	1.000	10.000
LH 01 29 013	2,9 x 13	1.000	10.000
LH 01 29 016	2,9 x 16	500	5.000
LH 01 29 019	2,9 x 19	500	5.000
LH 01 29 022	2,9 x 22	500	5.000
LH 01 29 025	2,9 x 25	500	5.000
LH 01 29 032	2,9 x 32	500	5.000
Ø 3,5 / Ph 2			
LH 01 35 009	3,5 x 9,5	1.000	10.000
LH 01 35 013	3,5 x 13	1.000	10.000
LH 01 35 016	3,5 x 16	500	5.000
LH 01 35 019	3,5 x 19	500	5.000
LH 01 35 022	3,5 x 22	500	5.000
LH 01 35 025	3,5 x 25	500	5.000
LH 01 35 032	3,5 x 32	500	5.000
LH 01 35 038	3,5 x 38	500	5.000
LH 01 35 045	3,5 x 45	200	2.000
LH 01 35 050	3,5 x 50	200	2.000
Ø 3,9 / Ph 2			
LH 01 39 009	3,9 x 9,5	1.000	10.000
LH 01 39 013	3,9 x 13	1.000	10.000
LH 01 39 016	3,9 x 16	500	5.000
LH 01 39 019	3,9 x 19	500	5.000
LH 01 39 022	3,9 x 22	500	5.000
LH 01 39 025	3,9 x 25	500	5.000
LH 01 39 032	3,9 x 32	500	5.000
LH 01 39 038	3,9 x 38	200	2.000
LH 01 39 045	3,9 x 45	200	2.000
LH 01 39 050	3,9 x 50	200	2.000
Ø 4,2 / Ph 2			
LH 01 42 009	4,2 x 9,5	1.000	10.000
LH 01 42 013	4,2 x 13	500	5.000
LH 01 42 016	4,2 x 16	500	5.000
LH 01 42 019	4,2 x 19	500	5.000
LH 01 42 022	4,2 x 22	500	5.000
LH 01 42 025	4,2 x 25	500	5.000
LH 01 42 032	4,2 x 32	200	2.000
LH 01 42 038	4,2 x 38	200	2.000
LH 01 42 045	4,2 x 45	200	2.000
LH 01 42 050	4,2 x 50	200	2.000
LH 01 42 060	4,2 x 60	200	2.000
LH 01 42 070	4,2 x 70	200	2.000
Ø 4,8 / Ph 2			
LH 01 48 009	4,8 x 9,5	1.000	10.000
LH 01 48 013	4,8 x 13	500	5.000
LH 01 48 016	4,8 x 16	500	5.000
LH 01 48 019	4,8 x 19	500	5.000
LH 01 48 022	4,8 x 22	500	5.000
LH 01 48 025	4,8 x 25	500	5.000
LH 01 48 032	4,8 x 32	200	2.000

>>>

LH 01 - LH 03

Flat csk head cross recess type H tapping screw, hardened

Vis autotaraudeuse tête fraisée plate empreinte cruciforme Type H, en acier cémenté

Senkkopf- Blechschraube, Kreuzschlitz H, einsatzgehärtet

Tornillo autorroscante, cabeza avellanada cruz tipo H, acero cementado

Оцинкованный шуруп-саморез из закаленной стали с плоской потайной головкой с крестообразным шлицем типа H

LH 01 zinc plated / zinguée / verzinkt / cincado / Оцинкованный

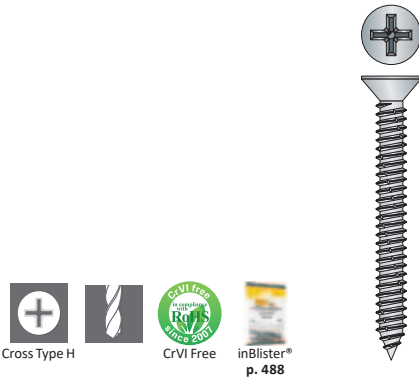

Box / Boîte / Verpackung / Caja / Упаковка



Item code	Screw size Ø x L / L ₁ (mm)	Pcs. per box	Pcs. per carton
Ø 4,8 / Ph 2			
LH 01 48 038	4,8 x 38	200	2.000
LH 01 48 045	4,8 x 45	200	2.000
LH 01 48 050	4,8 x 50	200	2.000
LH 01 48 060	4,8 x 60	100	1.000
LH 01 48 070	4,8 x 70 / 60	100	1.000
LH 01 48 080	4,8 x 80 / 60	100	1.000
Ø 5,5 / Ph 3			
LH 01 55 013	5,5 x 13	200	2.000
LH 01 55 016	5,5 x 16	200	2.000
LH 01 55 019	5,5 x 19	200	2.000
LH 01 55 022	5,5 x 22	200	2.000
LH 01 55 025	5,5 x 25	200	2.000
LH 01 55 032	5,5 x 32	200	2.000
LH 01 55 038	5,5 x 38	200	2.000
LH 01 55 045	5,5 x 45	200	2.000
LH 01 55 050	5,5 x 50	200	2.000
LH 01 55 060	5,5 x 60	100	1.000
LH 01 55 070	5,5 x 70 / 60	100	1.000
LH 01 55 080	5,5 x 80 / 60	100	1.000
LH 01 55 100	5,5 x 100 / 60	100	1.000
Ø 6,3 / Ph 3			
LH 01 63 016	6,3 x 16	200	2.000
LH 01 63 019	6,3 x 19	200	2.000
LH 01 63 022	6,3 x 22	200	2.000
LH 01 63 025	6,3 x 25	200	2.000
LH 01 63 032	6,3 x 32	200	2.000
LH 01 63 038	6,3 x 38	200	2.000
LH 01 63 045	6,3 x 45	200	2.000
LH 01 63 050	6,3 x 50	200	2.000
LH 01 63 060	6,3 x 60	100	1.000
LH 01 63 070	6,3 x 70 / 60	100	1.000
LH 01 63 080	6,3 x 80 / 60	100	1.000
LH 01 63 100	6,3 x 100 / 60	100	1.000

LH 03 black zinc plated / zinguée noire / schwarz verzinkt / cincado negro / Оцинкованный черного цвета



Box / Boîte / Verpackung / Caja / Упаковка



Item code	Screw size Ø x L (mm)	Pcs. per box	Pcs. per carton
Ø 4,8 / Ph 2			
LH 03 48 019	4,8 x 19	500	5.000
LH 03 48 022	4,8 x 22	500	5.000
LH 03 48 025	4,8 x 25	500	5.000
LH 03 48 032	4,8 x 32	500	5.000
LH 03 48 038	4,8 x 38	500	5.000

FH 01 - FH 02

🇬🇧 Mushroom head cross recess type H tapping screw, hardened

🇫🇷 Vis autotaraudeuse tête bombée empreinte cruciforme Type H, en acier cémenté

🇩🇪 Rundkopf-Blechschaube, einsatzgehärtet

🇪🇸 Tornillo autorroscante, cabeza abombada cruz tipo H, acero cementado

🇷🇺 Оцинкованный шуруп-саморез желтого цвета из закаленной стали с низкой полукруглой головкой с крестообразным шлицем типа H

FH 01 yellow zinc plated / zinguée jaune / gelb verzinkt / bicromatado / Оцинкованный желтого цвета

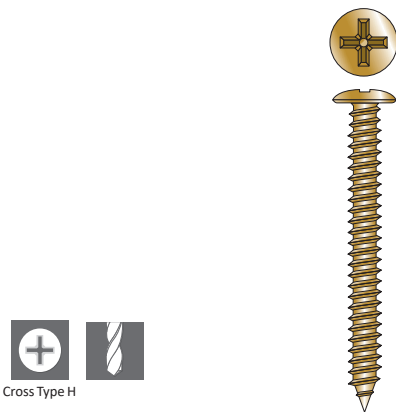

Item code	Screw size Ø x L / L ₁ (mm)	Pcs. per box	Pcs. per carton
Ø 4,8 / Ph 2			
FH 01 48 025	4,8 x 25	500	5.000
FH 01 48 038	4,8 x 38	500	5.000
FH 01 48 070	4,8 x 70 / 50	200	2.000
⚠ FH 01 48 080	4,8 x 80 / 50	200	2.000
⚠ FH 01 48 090	4,8 x 90 / 50	200	2.000
Ø 5,5 / Ph 3			
FH 01 55 025	5,5 x 25	500	5.000
FH 01 55 032	5,5 x 32	500	2.500
FH 01 55 038	5,5 x 38	500	2.500
⚠ FH 01 55 050	5,5 x 50	200	2.000
FH 01 55 070	5,5 x 70 / 50	200	2.000
⚠ FH 01 55 090	5,5 x 90 / 50	200	1.000
⚠ FH 01 55 100	5,5 x 100 / 50	200	1.000
⚠ FH 01 55 110	5,5 x 110 / 50	200	1.000
⚠ Until stockout / Jusqu'à épuisement des stocks / Solange der Vorrat reicht / Hasta agotar existencias / до окончания стока			

FH 02 zinc plated / zinguée / verzinkt / cincado / Оцинкованный

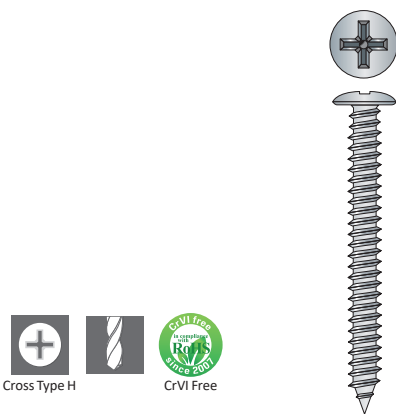

Item code	Screw size Ø x L / L ₁ (mm)	Pcs. per box	Pcs. per carton
Ø 4,8 / Ph 2			
FH 02 48 013	4,8 x 13	1.000	10.000
FH 02 48 019	4,8 x 19	1.000	10.000
FH 02 48 025	4,8 x 25	500	5.000
FH 02 48 032	4,8 x 32	500	5.000
FH 02 48 038	4,8 x 38	500	5.000
FH 02 48 050	4,8 x 50	200	2.000
FH 02 48 060	4,8 x 60 / 50	200	2.000
FH 02 48 070	4,8 x 70 / 50	200	2.000
FH 02 48 080	4,8 x 80 / 50	200	2.000
FH 02 48 090	4,8 x 90 / 50	200	2.000
Ø 5,5 / Ph 3			
FH 02 55 013	5,5 x 13	1.000	5.000
FH 02 55 019	5,5 x 19	1.000	5.000
FH 02 55 025	5,5 x 25	500	5.000
FH 02 55 038	5,5 x 38	500	2.500
FH 02 55 050	5,5 x 50	200	2.000
FH 02 55 060	5,5 x 60 / 50	200	2.000
FH 02 55 070	5,5 x 70 / 50	200	2.000
FH 02 55 080	5,5 x 80 / 50	200	2.000
FH 02 55 090	5,5 x 90 / 50	200	1.000
FH 02 55 100	5,5 x 100 / 50	200	1.000

Usage / Utilisation / Benutzung / Uso / Применение

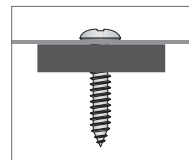

Pre-drill holes, see p. 84 / Trous de préparation, voir p. 84 / Vorbereitungslöcher, siehe p. 84 / Pretaladros, consulte p. 84 / Предварительное сверление, п. 84

Box / Boîte / Verpackung
Caja / Упаковка

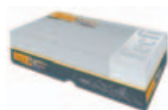

Technical
Data Sheet



FH 04

Mushroom head cross recess type H tapping screw, hardened

 Vis autotaraudeuse tête bombée empreinte cruciforme Type H, en acier cémenté

 Rundkopf-Blechschaube, einsatzgehärtet

 Tornillo autorroscante, cabeza abombada cruz tipo H, acero cementado

 Оцинкованный шуруп-саморез желтого цвета из закаленной стали с низкой полукруглой головкой с крестообразным шлицем типа H

FH 04 black zinc plated / zinguée noire / schwarz verzinkt / cincado negro / Оцинкованный черного цвета

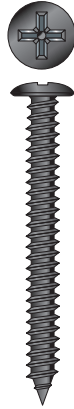

Cross Type H

Item code	Screw size Ø x L / L ₁ (mm)	Pcs. per box	Pcs. per carton
Ø 4,8 / Ph 2			
FH 04 48 013	4,8 x 13	1.000	10.000
FH 04 48 019	4,8 x 19	1.000	10.000
FH 04 48 025	4,8 x 25	500	5.000
FH 04 48 032	4,8 x 32	500	5.000
FH 04 48 038	4,8 x 38	500	5.000
FH 04 48 050	4,8 x 50	200	2.000
FH 04 48 060	4,8 x 60 / 50	200	2.000
FH 04 48 070	4,8 x 70 / 50	200	2.000
FH 04 48 080	4,8 x 80 / 50	200	2.000
Ø 5,5 / Ph 3			
FH 04 55 013	5,5 x 13	1.000	5.000
FH 04 55 019	5,5 x 19	1.000	5.000
FH 04 55 025	5,5 x 25	500	5.000
FH 04 55 032	5,5 x 32	500	2.500
FH 04 55 038	5,5 x 38	500	2.500
FH 04 55 050	5,5 x 50	200	2.000
FH 04 55 060	5,5 x 60 / 50	200	2.000
FH 04 55 070	5,5 x 70 / 50	200	2.000
FH 04 55 090	5,5 x 90 / 50	200	1.000

 **Until stockout** / Jusqu'à épuisement des stocks / Solange der Vorrat reicht / Hasta agotar existencias / до окончания стока

Usage / Utilisation / Benutzung / Uso / Применение

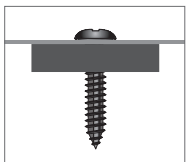

Pre-drill holes, see p. 84 / Trous de préparation, voir p. 84 / Vorbereitungslöcher, siehe p. 84 / Pretaladros, consulte p. 84 / Предварительное сверление, p. 84

Box / Boîte / Verpackung
Caja / Упаковка

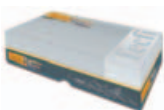

Technical
Data Sheet





LX 01 - LX 03

 Until stockout
 Jusqu'à épuisement de stocks
 Solange der Vorrat reicht
 Hasta agotar existencias
 до окончания стока

Pan washer head cross recess type H tapping screw, hardened

 Vis autotaraudeuse tête cylindrique empreinte cruciformes type H, en acier cémenté

 Tellerkopf - Blechschraube Kreuzschlitz H, einsatzgehärtet

 Tornillo autorroscante, cabeza cilíndrica cruz tipo H con arandela estampada, acero cementado

 Оцинкованный шуруп-саморез из закаленной стали с полукруглой головкой с пресс-шайбой с крестообразным шлицем типа H

LX 01 zinc plated / zinguée / verzinkt / cincado / Оцинкованный

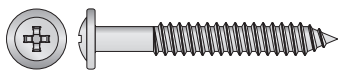

Cross Type H

CrVI Free

Item code	Screw size Ø x L / L ₁ (mm)	Pcs. per box	Pcs. per carton
Ø 5,5 / Ph 3			
LX 01 55 032	5,5 x 32	500	5.000
LX 01 55 060	5,5 x 60 / 50	200	2.000
LX 01 55 080	5,5 x 80 / 50	200	2.000

LX 03 black zinc plated / zinguée noire / schwarz verzinkt / cincado negro / Оцинкованный черного цвета

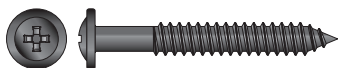

Cross Type H

Usage / Utilisation / Benutzung / Uso / Применение

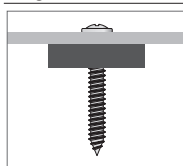

Pre-drill holes, see p. 84 / Trous de préparati on, voir p. 84 / Vorbereitungs-löcher, siehe p. 84 / Pretaladros, consulte p. 84 / Предварительное сверление, p. 84

Box / Boîte / Verpackung / Caja / Упаковка



Item code	Screw size Ø x L / L ₁ (mm)	Pcs. per box	Pcs. per carton
Ø 5,5 / Ph 3			
LX 03 55 060	5,5 x 60 / 50	200	2.000
LX 03 55 080	5,5 x 80 / 50	200	2.000

HU 03

Pan washer head 6-lobe recess screw for plastic, hardened, black zinc plated

 Vis tête cylindrique à six lobes pour plastique, en acier cémenté, zinguée noire

 Zylinderkopfschraube für Plastik, Innensechsrund, einsatzgehärtet, schwarz verzinkt

 Tornillo para plástico, cabeza cilíndrica 6 lóbulos internos con arandela estampada, acero cementado, cincado negro

 Оцинкованный шуруп черного цвета из закаленной стали для пластика с полукруглой головкой с пресс-шайбой, с шестигранным шлицем



6-lobe

Item code	Screw size Ø x L (mm)	Pcs. per box	Pcs. per carton
Ø 6 / T-30			
HU 03 06 018	6 x 18	200	2.000

Usage / Utilisation / Benutzung / Uso / Применение

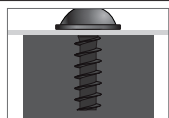

Pre-drill holes, see p. 84 / Trous de préparati on, voir p. 84 / Vorbereitungs-löcher, siehe p. 84 / Pretaladros, consulte p. 84 / Предварительное сверление, p. 84

Box / Boîte / Verpackung / Caja / Упаковка



EF 01

🇬🇧 Cylinder head hex recess machine screw, zinc plated

🇫🇷 Vis tête cylindrique à six pans creux, zinguée

🇩🇪 Zylinderkopfschraube mit Innensechskant, verzinkt

🇪🇸 Tornillo rosca métrica, cabeza cilíndrica huella hexagonal, cincado

🇷🇺 Оцинкованный винт с цилиндрической головкой с внутренним шестигранником

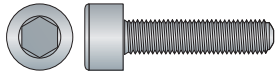

In-Hex
S



CrVI Free

Item code	Screw size M x L / L ₁ (mm)	Pcs. per box	Pcs. per carton
M6 / In-Hex (s): 5			
EF 01 06 012	M6 x 12	250	2.500
EF 01 06 016	M6 x 16	250	2.500
EF 01 06 018	M6 x 18	250	2.500
EF 01 06 020	M6 x 20	250	2.500
EF 01 06 025	M6 x 25	250	2.500
EF 01 06 030	M6 x 30	250	2.500
EF 01 06 040	M6 x 40 / 24	250	2.500

CZ 01

🇬🇧 Cylinder head hex recess tapping screw, hardened, zinc plated

🇫🇷 Vis autotaraudeuse, tête cylindrique à six pans creux, en acier cémenté, zinguée

🇩🇪 Zylinderkopf- Blechschraube mit Innensechskant, einsatzgehärtet, verzinkt

🇪🇸 Tornillo autorroscante, cabeza cilíndrica huella hexagonal, acero cementado, cincado

🇷🇺 Оцинкованный шуруп-саморез из закаленной стали с цилиндрической головкой с внутренним шестигранником

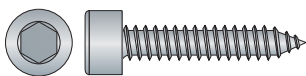

In-Hex
S



CrVI Free

Item code	Screw size Ø x L (mm)	Pcs. per box	Pcs. per carton
Ø 4,8 / In-Hex (s): 5			
CZ 01 48 013	4,8 x 13	1.000	5.000
CZ 01 48 016	4,8 x 16	1.000	5.000
CZ 01 48 019	4,8 x 19	1.000	5.000
CZ 01 48 022	4,8 x 22	1.000	5.000
CZ 01 48 025	4,8 x 25	1.000	5.000
CZ 01 48 032	4,8 x 32	500	5.000
CZ 01 48 038	4,8 x 38	500	2.500
CZ 01 48 045	4,8 x 45	400	2.000
CZ 01 48 050	4,8 x 50	400	2.000
CZ 01 48 060	4,8 x 60	400	2.000
CZ 01 48 070	4,8 x 70	400	2.000
Ø 5,5 / In-Hex (s): 5			
CZ 01 55 013	5,5 x 13	500	5.000
CZ 01 55 016	5,5 x 16	500	5.000
CZ 01 55 019	5,5 x 19	500	5.000
CZ 01 55 022	5,5 x 22	500	5.000
CZ 01 55 025	5,5 x 25	500	5.000
CZ 01 55 032	5,5 x 32	500	2.500
CZ 01 55 038	5,5 x 38	500	2.500
CZ 01 55 045	5,5 x 45	200	2.000
CZ 01 55 050	5,5 x 50	200	2.000
CZ 01 55 060	5,5 x 60	200	2.000
CZ 01 55 070	5,5 x 70	200	2.000
Ø 6,3 / In-Hex (s): 5			
CZ 01 63 016	6,3 x 16	500	5.000
CZ 01 63 019	6,3 x 19	500	5.000
CZ 01 63 022	6,3 x 22	500	2.500
CZ 01 63 025	6,3 x 25	200	2.000
CZ 01 63 032	6,3 x 32	200	2.000
CZ 01 63 038	6,3 x 38	200	2.000
CZ 01 63 045	6,3 x 45	200	2.000
CZ 01 63 050	6,3 x 50	200	2.000
CZ 01 63 060	6,3 x 60	200	2.000
CZ 01 63 070	6,3 x 70	200	1.000
CZ 01 63 080	6,3 x 80	200	1.000

Usage / Utilisation / Benutzung / Uso / Применение

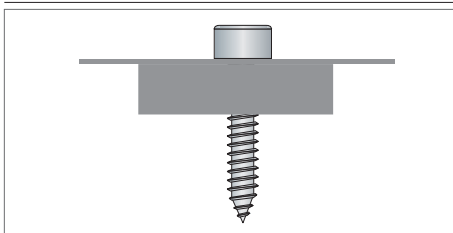

Pre-drill holes, see p. 84 / Trous de préparati on, voir p. 84 /
Vorbereitungslöcher, siehe p. 84 / Pretaladros, consulte p. 84 /
Предварительное сверление, p. 84

Box / Boîte / Verpackung / Caja / Упаковка



AY

🇬🇧 Nylon anchor with combi (slotted/pozi) recess CSK screw and rubber (PVC) cone shaped door-stop

🇫🇷 Cheville en Nylon avec vis combi (empreinte cannelée/pozi) tête fraisée et butoir de porte en gomme (PVC)

🇩🇪 Nylandübel mit Kombi Senkkopfschraube (Pozi/Schlitz) und Türstopper mit Gummi (PVC)

🇪🇸 Taco de nylon con tornillo y tope de puertas

🇷🇺 Нейлоновый дюбель в комплекте с шурупом с потайной головкой с комбинированным шлицем, в комплекте с резиновым (ПВХ) ограничителем открывания

M4 door-stop \varnothing 20 mm / Arrêt de porte \varnothing 20mm / Türstopper \varnothing 20 mm / Tope de puertas \varnothing 20 mm / бампер \varnothing 20 мм

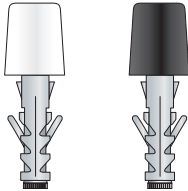

Item code	Anchor size $\varnothing \times L$ (mm)	Screw size M	Colour	Pcs. per box	Pcs. per carton
Door-stop \varnothing 20mm					
AY 13 09 040	9 x 40	M4	Bianco	50	500
AY 14 09 040	9 x 40	M4	Nero	50	500

M5 door-stop \varnothing 30 mm / Arrêt de porte \varnothing 30mm / Türstopper \varnothing 30 mm / Tope de puertas \varnothing 30 mm / бампер \varnothing 30 мм

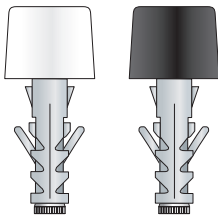

Item code	Anchor size $\varnothing \times L$ (mm)	Screw size M	Colour	Pcs. per box	Pcs. per carton
Door-stop \varnothing 30mm					
AY 15 12 045	12 x 45	M5	Bianco	25	250
AY 16 12 045	12 x 45	M5	Nero	25	250

DY

🇬🇧 Zinc plated steel anchor with combi (slotted/pozi) recess CSK screw and rubber (PVC) cone shaped door-stop

🇫🇷 Cheville en Nylon avec vis combi (empreinte cannelée/pozi) tête fraisée et butoir de porte en gomme (PVC)

🇩🇪 Nylandübel mit Kombi Senkkopfschraube (Pozi/Schlitz) und Türstopper mit Gummi (PVC)

🇪🇸 Taco de acero cincado con tornillo, arandela y tope de puertas

🇷🇺 Нейлоновый дюбель в комплекте с шурупом с потайной головкой с комбинированным шлицем, в комплекте с резиновым (ПВХ) ограничителем открывания

M4 door-stop \varnothing 20 mm / Arrêt de porte \varnothing 20mm / Türstopper \varnothing 20 mm / Tope de puertas \varnothing 20 mm / бампер \varnothing 20 мм

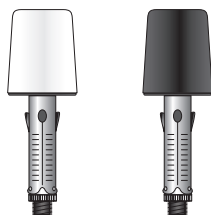

Item code	Anchor size $\varnothing \times L$ (mm)	Screw size M	Colour	Pcs. per box	Pcs. per carton
Door-stop \varnothing 20mm					
DY 17 08 035	8 x 35	M4	Bianco	50	500
DY 18 08 035	8 x 35	M4	Nero	50	500

M5 door-stop \varnothing 30 mm / Arrêt de porte \varnothing 30mm / Türstopper \varnothing 30 mm / Tope de puertas \varnothing 30 mm / бампер \varnothing 30 мм

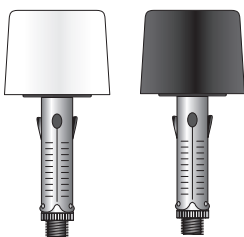

Item code	Anchor size $\varnothing \times L$ (mm)	Screw size M	Colour	Pcs. per box	Pcs. per carton
Door-stop \varnothing 30mm					
DY 19 09 040	9 x 40	M5	Bianco	25	250
DY 20 09 040	9 x 40	M5	Nero	25	250

Usage / Utilisation / Benutzung / Uso / Применение

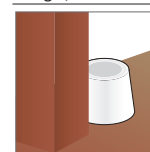

Easy to install, for door/window stop.

CQ

Steel anchor with wings, with hex head screw and rubber (PVC) cone shaped door-stop

- 🇮🇹 Cheville zinguée avec deux ailettes, avec vis tête hexagonale et butoir de porte en gomme (PVC)
- 🇩🇪 Verzinkter Anker mit zwei Flügel, mit Sechskantschraube und Türstopper mit Gummi (PVC)
- 🇪🇸 Anclaje de acero cincado con dos alas, con tornillo y tope de puertas
- 🇷🇺 Втулочный стальной оцинкованный анкер с блокировочными усами в комплекте с резиновым (ПВХ) ограничителем открывания

Ø12 door-stop Ø 30 mm / Arrêt de porte Ø 30mm / Türstopper Ø 30 mm / Tope de puertas Ø 30 mm / бампер Ø 30 мм

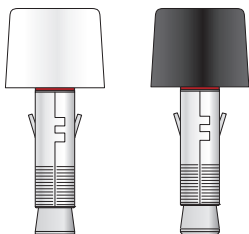

Item code	Anchor size Ø x L (mm)	Screw size M	Colour	Pcs. per box	Pcs. per carton
Door-stop Ø 30mm					
CQ 13 12 045	12 x 45	M6	Bianco	25	250
CQ 14 12 045	12 x 45	M6	Nero	25	250

HX

Hexagonal washer head concrete screw, zinc plated, with rubber (PVC) cone shaped door-stop

- 🇮🇹 Vis à béton tête hexagonale à embase avec rondelle intégrée moletée sous la tête, en acier zingué, avec butoir de porte en gomme (PVC)
- 🇩🇪 Verzinkte Sechskant-Betonschraube mit gerändelter Unterlegscheibe mit Flansch und Türstopper mit Gummi (PVC)
- 🇪🇸 Tornillo para hormigón con cabeza hexagonal y arandela estampada rebordeada con estrías bloqueadoras, de acero cementado, con tope de puertas
- 🇷🇺 Стальной оцинкованный шуруп по бетону с шестигранной головкой со скошенным буртом в комплекте с резиновым (ПВХ) ограничителем открывания

Ø6,6 door-stop Ø 30 mm / Arrêt de porte Ø 30mm / Türstopper Ø 30 mm / Tope de puertas Ø 30 mm / бампер Ø 30 мм

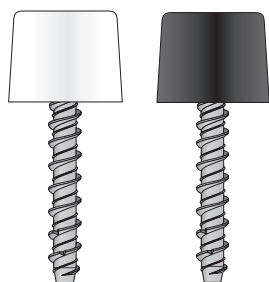

Item code	Screw size Ø x L (mm)	Colour	Pcs. per box	Pcs. per carton
Door-stop Ø 30mm				
HX 23 06 060	6,6 x 60	Bianco	25	250
HX 24 06 060	6,6 x 60	Nero	25	250

Usage / Utilisation / Benutzung / Uso / Применение



Easy to install on concrete (without plug), for door/window stop.

LZ

INOX WAVE
Stainless Steel

A2 (AISI 304) Stainless Steel anchor with hex head screw and rubber (PVC) cone shaped door-stop

- 🇮🇹 Cheville à douille en acier INOX A2 (AISI 304), avec vis tête hexagonale et avec butoir de porte en gomme (PVC)
- 🇩🇪 Verzinkter Hülsenanker aus Edelstahl A2 (AISI 304), mit Sechskantschraube und Türstopper mit Gummi(PVC)
- 🇪🇸 Anclaje de camisa con tornillo cabeza hexagonal, de Acero Inoxidable A2 (AISI 304), con tope de puertas
- 🇷🇺 Втулочный анкер из нержавеющей стали A2 (AISI 304) в комплекте с резиновым (ПВХ) ограничителем открывания

Ø8 door-stop Ø 30 mm / Arrêt de porte Ø 30mm / Türstopper Ø 30 mm / Tope de puertas Ø 30 mm / бампер Ø 30 мм

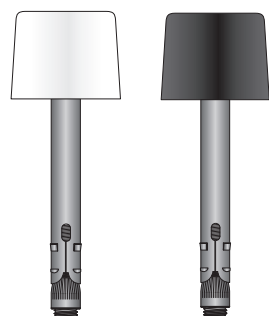

Item code	Anchor size Ø x L (mm)	Screw size M	Colour	Pcs. per box	Pcs. per carton
Door-stop Ø 30mm					
LZ 53 08 060	8 x 60	M6	Bianco	25	250
LZ 54 08 060	8 x 60	M6	Nero	25	250

Usage / Utilisation / Benutzung / Uso / Применение

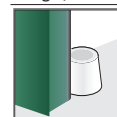

Easy to install on concrete, for door/window stop. Also suitable for outdoor application.

WT

🇬🇧 Rubber (PVC) truncated cone shaped door-stop

- 🇫🇷 Arrêt de porte en PVC avec trou dans l'intérieur
- 🇩🇪 Türstopper aus PVC mit Innenloch
- 🇪🇸 Tope de puertas en PVC, con agujero
- 🇷🇺 Конус бампер с внутренним отверстием, из ПВХ

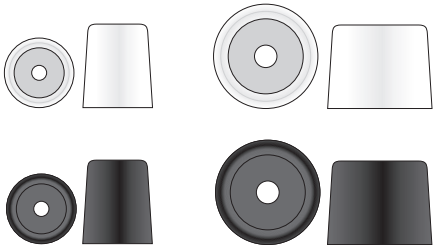

Item code	Size Ø x h (mm)	Colour	Pcs. per box	Pcs. per carton
Door-stop Ø 20mm				
WT 01 20 023	20 x 23	White	100	1.000
WT 02 20 023	20 x 23	Black	100	1.000
Door-stop Ø 30mm				
WT 01 30 023	30 x 23	White	50	500
WT 02 30 023	30 x 23	Black	50	500

HG

🇬🇧 Until stockout
 🇫🇷 Jusqu'à épuisement de stocks
 🇩🇪 Solange der Vorrat reicht
 🇪🇸 Hasta agotar existencias
 🇷🇺 до окончания стока

Stop&GO®

🇬🇧 Magnetic door-stop, with floor and door fixing accessories

- 🇫🇷 Ferme-porte magnétique avec accessoires pour la fixation sur le sol et la porte
- 🇩🇪 Magnetischer Türschließer mit Boden- und Türzubehöre
- 🇪🇸 Tope de puertas magnético, con accesorios para la fijación al suelo y a la puerta
- 🇷🇺 Магнитный ограничитель открывания двери с комплектующими для напольного и дверного крепления



Item code	Finition	Pcs. per box	Pcs. per carton
HG 01 45 037	Shiny Gold	6	24
HG 02 45 037	Satiny Gold	6	24
HG 03 45 037	Shiny Chromium	6	24
HG 05 45 037	Bronzed	6	24

Box / Boîte / Verpackung / Caja / Упаковка



Installation sequence / Instructions de mise en oeuvre / Setzanweisung / Secuencia de instalación / Порядок монтажа

