

	✠ Flat CSK head with ribs 6-lobe recess chipboard screw, CE Certified	<ul style="list-style-type: none"> 🇫🇷 Vis tête fraisée plate à six lobes, pour panneaux de particules 🇩🇪 Senkkopf- Spanplattenschraube, Innensechsrund 🇪🇸 Tornillo para aglomerado, cabeza avellanada 6 lóbulos internos 🇷🇺 Шуруп по дереву с шестигранным шлицем 	280
	✠ Special conical washers for TT-Woodpecker® CSK head screws	<ul style="list-style-type: none"> 🇫🇷 Rondelles spéciales pour vis tête fraisée plate TT-Woodpecker® 🇩🇪 Spezielle Scheiben für TT-Woodpecker® Senkkopfschrauben 🇪🇸 Arandelas cónicas para tornillos TT-Woodpecker® 🇷🇺 Специальная коническая шайба для шурупов с плоской потайной головкой TT-Woodpecker® 	282
	✠ Flat CSK head chipboard screw various finishings, CE Certified	<ul style="list-style-type: none"> 🇫🇷 Vis tête fraisée plate pour panneaux de particules en plusieurs finitions 🇩🇪 Senkkopf- Spanplattenschraube mit verschiedenen Behandlungen 🇪🇸 Tornillo para aglomerado, cabeza avellanada, varios acabados 🇷🇺 Шуруп по дереву из закаленной стали с плоской потайной головкой в разных отделах 	284
	✠ A2 Stainless Steel Flat CSK head chipboard screw, CE Certified	<ul style="list-style-type: none"> 🇫🇷 Vis tête fraisée plate pour panneaux de particules en acier inox A2 🇩🇪 Senkkopf- Spanplattenschraube aus Edelstahl A2 🇪🇸 Tornillo para aglomerado, cabeza avellanada de Acero Inoxidable A2 🇷🇺 Шуруп по дереву из нержавеющей стали с плоской потайной головкой 	302
	✠ Flat CSK reduced head chipboard screw various finishings	<ul style="list-style-type: none"> 🇫🇷 Vis autoperceuse tête fraisée réduite pour panneaux de particules, différentes finitions 🇩🇪 Senkkopf- Spanplattenschraube mit reduziertem Flachkopf und verschiedenen Spezialbehandlungen 🇪🇸 Tornillos para aglomerado con cabeza avellanada reducida, varios acabados 🇷🇺 Шуруп с уменьшенной потайной головкой в разных отделах 	304
	✠ Pan head chipboard screw, CE Certified	<ul style="list-style-type: none"> 🇫🇷 Vis tête cylindrique pour panneaux de particules 🇩🇪 Zylinderkopf- Spanplattenschraube 🇪🇸 Tornillo para aglomerado, cabeza cilíndrica 🇷🇺 Шуруп по дереву с цилиндрической скругленной головкой 	306
	✠ Raised (oval) CSK head with ribs chipboard screw	<ul style="list-style-type: none"> 🇫🇷 Vis tête fraisée bombée pour panneaux de particules 🇩🇪 Linsensenkopfschraube für Spanplatte 🇪🇸 Tornillo para aglomerado, cabeza avellanada abombada 🇷🇺 Шуруп по дереву с полупотайной головкой с насечками 	309
	✠ CSK and Pan head wood screw	<ul style="list-style-type: none"> 🇫🇷 Vis tête fraisée plate et cylindrique 🇩🇪 Senkkopf- und Tellerkopf Schraube 🇪🇸 Tornillo para madera con cabeza avombada 6 lóbulos internos 🇷🇺 Шуруп с низкой полукруглой головкой 	310
	✠ DIN 571 Steel hexagonal head wood screws, CE Certified	<ul style="list-style-type: none"> 🇫🇷 DIN 571 - Vis à bois tête hexagonale 🇩🇪 DIN 571 - Sechskant- Holzschraube 🇪🇸 DIN 571 - Tornillos para madera, cabeza hexagonal 🇷🇺 DIN 571 - Стальной шуруп с шестигранной головкой 	312
	✠ FLAT CSK head wood screws for BE series nylon anchors	<ul style="list-style-type: none"> 🇫🇷 Vis à bois tête fraisée plate pour cheville nylon BE 🇩🇪 Senkkopf- Holzschraube für Nylohdübel BE 🇪🇸 Tornillos para madera con cabeza avellanada, para tacos de nylon serie BE 🇷🇺 Шурупы с плоской потайной головкой для нейлоновых дюбелей BE 	314
	✠ Mushroom head 6-lobe recess wood screws	<ul style="list-style-type: none"> 🇫🇷 Vis spéciale à bois tête bombée à six lobes 🇩🇪 Spezielle Rundkopf- Holzschraube mit Innensechsrund 🇪🇸 Tornillos para madera con cabeza avellanada y cabeza cilíndrica 🇷🇺 Шуруп с низкой полукруглой головкой 	315
	✠ Special screws for VS-Handyplug universal anchors	<ul style="list-style-type: none"> 🇫🇷 Vis à bois spéciale empreinte six lobes X pour chevilles VS- Handyplug® 🇩🇪 Spezielle Holzschraube mit Innensechsrund für VS- Handyplug® Nylohdübel 🇪🇸 Tornillos especial para madera, para tacos universales VS-Handyplug® 🇷🇺 Шуруп с плоской потайной головкой и шестигранным шлицем для дюбелей VS-Handyplug® 	316
	✠ “L”, hook and eye screws for wood	<ul style="list-style-type: none"> 🇫🇷 Vis crochet droit, rond et oeillet à bois 🇩🇪 Holzschraube mit Haken, Rundhaken und Augenschraube 🇪🇸 Ganchos y argolla para madera 🇷🇺 “L”-образные шурупы, крюки и кольца для дерева 	319
	✠ Special screws with ring	<ul style="list-style-type: none"> 🇫🇷 Vis spéciales 🇩🇪 Besondere Schrauben 🇪🇸 Tornilleria especial 🇷🇺 Специальный кольцо-шуруп 	321
	✠ Adhesives coloured round cover for screws	<ul style="list-style-type: none"> 🇫🇷 Adhésif coloré pour vis 🇩🇪 Gefärbte Aufkleber für Schrauben 🇪🇸 Tapones adhesivos colorados para tornillos 🇷🇺 Цветные круглые наклейки для шурупов 	322
	✠ Wood beam connectors, ETA Approved	<ul style="list-style-type: none"> 🇫🇷 Connecteurs pour le bois 🇩🇪 Holzverbinder 🇪🇸 Conectores para vigas de madera 🇷🇺 Перфорированный крепеж для дерева 	324
	✠ Wood post bases	<ul style="list-style-type: none"> 🇫🇷 Pieds de poteau 🇩🇪 Einschlagbodenhülse 🇪🇸 Soportes para anclar vigas de madera al suelo 🇷🇺 Основания для деревянных балок 	338
	✠ KIT - Wood beam connectors and post bases	<ul style="list-style-type: none"> 🇫🇷 Présentoir avec assortiment de connexions pour le bois 🇩🇪 Verkaufsständer mit Sortiment von Holz- und Balkenverbindungen 🇪🇸 Kit conectores y soportes para viga de madera 🇷🇺 Ассортимент соединений и опор для клееного бруса 	342
	✠ Steel plain washers extra large and Hex domed cap nuts	<ul style="list-style-type: none"> 🇫🇷 Rondelles extra large et écrous barge à calotte 🇩🇪 Extra Scheiben und Hutmütter 🇪🇸 Arandelas anchos y tuercas ciegas 🇷🇺 Увеличенная шайба и колпачковая шестигранная гайка 	344

✠ Woodpecker® - Wood line

- 🇫🇷 Woodpecker® - Ligne bois
- 🇩🇪 Woodpecker® - Holz-Linie
- 🇪🇸 Woodpecker® - Línea madera
- 🇷🇺 Woodpecker® - Линии для дерева

Flat CSK head with ribs 6-lobe recess chipboard screw with reamer and special patented thread, GOLD yellow ZP (CrVI free) and waxed

- Vis tête fraisée plate à six lobes, pour panneaux de particules, avec nervures et alésoir, filetage breveté, zingué jaune or (sans CrVI)
- Senkkopf- Spanplattenschraube, Innensechsrund, mit Fräsrippen und Reibahle, Gewinde patentiert, GOLD gelb ZP (CrVI frei) verzinkt und gewachst
- Tornillo para aglomerado, cabeza avellanada 6 lóbulos internos con estrías avellanadoras, con fresa y especial rosca patentada, bicromatado (efecto dorado – libre de CrVI) y encerado
- Запатентованный оцинкованный шуруп по дереву золотого цвета (GOLD без содержания Cr6) с плоской потайной головкой с шестигранным шлицем, со спиральной накаткой на стержне и специальным восковым покрытием

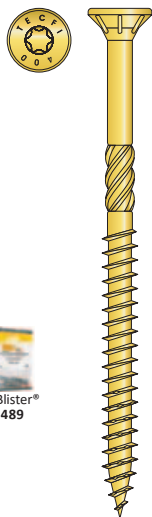

CE Certified according to the EN 14592:2008+A1:2012, for structural timber applications. Nominal diameter and technical details in: DoP n. P1210/13-630-1-TT



"Gold type - CrVI free" special coating



The new Tecfi "Gold type - CrVI free" coating, is a very appreciated deep yellow zinc plating, totally in compliance with REACH Regulation. For more info, please see technical introduction on page 15.

Box / Boîte / Verpackung
Caja / Упаковка

Usage / Utilisation / Benutzung
Uso / Применение



Included in TADS - Tecfi Anchor Design Software for computer aided design of Anchorage.

Tecfi Anchor Design Software
www.tecfi.it/tads

Item code	Screw size Ø x L / L ₁ (mm)	Pcs. per box	Pcs. per carton
Ø 6 / T-30			
CE TT 02 06 080	6 x 80 / 45	100	1.000
CE TT 02 06 090	6 x 90 / 45	100	1.000
CE TT 02 06 100	6 x 100 / 60	100	1.000
CE TT 02 06 110	6 x 110 / 60	100	1.000
CE TT 02 06 120	6 x 120 / 60	100	1.000
CE TT 02 06 130	6 x 130 / 60	100	1.000
CE TT 02 06 140	6 x 140 / 60	100	1.000
CE TT 02 06 150	6 x 150 / 60	100	1.000
CE TT 02 06 160	6 x 160 / 80	100	1.000
CE TT 02 06 180	6 x 180 / 80	100	1.000
CE TT 02 06 200	6 x 200 / 80	100	1.000
CE TT 02 06 220	6 x 220 / 80	100	800
CE TT 02 06 240	6 x 240 / 80	50	250
CE TT 02 06 260	6 x 260 / 80	50	250
CE TT 02 06 280	6 x 280 / 80	50	250
CE TT 02 06 300	6 x 300 / 80	50	250
Ø 8 / T-40			
CE TT 02 08 080	8 x 80 / 50	100	1.000
CE TT 02 08 090	8 x 90 / 50	100	1.000
CE TT 02 08 100	8 x 100 / 60	100	1.000
CE TT 02 08 120	8 x 120 / 60	100	800
CE TT 02 08 140	8 x 140 / 60	50	400
CE TT 02 08 160	8 x 160 / 80	50	400
CE TT 02 08 180	8 x 180 / 80	50	400
CE TT 02 08 200	8 x 200 / 100	50	400
CE TT 02 08 220	8 x 220 / 100	50	400
CE TT 02 08 240	8 x 240 / 100	50	250
CE TT 02 08 260	8 x 260 / 100	50	250
CE TT 02 08 280	8 x 280 / 100	50	250
CE TT 02 08 300	8 x 300 / 100	50	250
CE TT 02 08 320	8 x 320 / 100	50	150
CE TT 02 08 340	8 x 340 / 100	50	150
CE TT 02 08 360	8 x 360 / 100	50	150
CE TT 02 08 380	8 x 380 / 100	50	150
CE TT 02 08 400	8 x 400 / 100	50	150
Ø 10 / T-40			
CE TT 02 10 080 *	10 x 80 / 60	50	600
CE TT 02 10 090 *	10 x 90 / 60	50	600
CE TT 02 10 100	10 x 100 / 60	50	600
CE TT 02 10 120	10 x 120 / 60	50	400
CE TT 02 10 140	10 x 140 / 60	50	400
CE TT 02 10 160	10 x 160 / 80	50	400
CE TT 02 10 180	10 x 180 / 80	50	350
CE TT 02 10 200	10 x 200 / 100	50	300
CE TT 02 10 220	10 x 220 / 100	50	300
CE TT 02 10 240	10 x 240 / 100	50	200
CE TT 02 10 260	10 x 260 / 100	50	200
CE TT 02 10 280	10 x 280 / 100	50	200
CE TT 02 10 300	10 x 300 / 100	50	200
CE TT 02 10 320	10 x 320 / 100	50	150
CE TT 02 10 340	10 x 340 / 100	50	150
CE TT 02 10 360	10 x 360 / 100	50	150
CE TT 02 10 380	10 x 380 / 100	50	150
CE TT 02 10 400	10 x 400 / 100	50	150

CE CE Certified / Certifié CE / CE Zulassung / Certificado CE / Сертификат CE

Fire Reaction A1 / Réaction au feu A1 / Brandverhalten A1 / Reacción al fuego A1 / Реакция на огонь A1

* Without reamer / Mesures sans Alésoir / Maßnahmen ohne Reibahle / Medidas sin Escariador / Размеры без накатки

🇬🇧 A2 (AISI 304) stainless steel Flat CSK head with ribs 6-lobe recess chipboard screw with reamer and special patented thread, passivated and waxed

- 🇫🇷 Vis tête fraisée plate pour panneaux de particules, empreinte à six lobes, en acier inox A2 (AISI 304), avec filetage breveté et alésoir, passivée et cirée
- 🇩🇪 Spanplatte- Senkkopfschraube, Innensechsrund, aus Edelstahl A2 (AISI 304), Gewinde patentiert und Reibahle, passiviert und mit Wachs
- 🇪🇸 Tornillo para aglomerado, cabeza avellanada 6 lóbulos internos con estrías avellanadoras, con fresa y especial rosca patentada, de acero Inoxidable A2 (AISI 304), pasivado y encerado
- 🇷🇺 Шуруп по дереву из нержавеющей стали A2 (AISI 304) с плоской потайной головкой с шестигранным шлицем, с накаткой и запатентованной резьбой, со специальным восковым покрытием

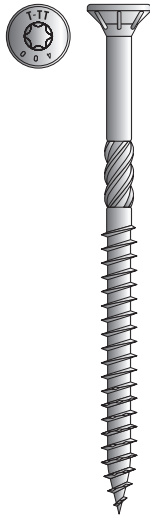

Item code	Screw size Ø x L / L ₁ (mm)	Pcs. per box	Pcs. per carton
Ø 6 / T-30			
CE 🔥 TT 50 06 080	6 x 80 / 45	100	1.000
CE 🔥 TT 50 06 100	6 x 100 / 60	100	1.000
CE 🔥 TT 50 06 120	6 x 120 / 60	100	1.000
CE 🔥 TT 50 06 140	6 x 140 / 60	100	1.000
CE 🔥 TT 50 06 160	6 x 160 / 80	100	1.000
CE 🔥 TT 50 06 180	6 x 180 / 80	100	1.000
CE 🔥 TT 50 06 200	6 x 200 / 80	100	1.000
CE 🔥 TT 50 06 220	6 x 220 / 80	100	800
CE 🔥 TT 50 06 240	6 x 240 / 80	50	250
CE 🔥 TT 50 06 260	6 x 260 / 80	50	250

CE Certified / Certifié CE / CE Zulassung / Certificado CE / Сертификат CE
 🔥 Fire Reaction A1 / Réaction au feu A1 / Brandverhalten A1 / Reacción al fuego A1 / Реакция на огонь A1



CE Certified according to the EN 14592:2008+A1:2012, for structural timber applications. Nominal diameter and technical details in: DoP n. P1210/13-630-1-TT



Box / Boîte / Verpackung
Caja / Упаковка

Usage / Utilisation / Benutzung
Uso / Применение

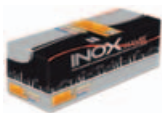

Included in TADS - Tecfi Anchor Design Software for computer aided design of Anchorage.

Tecfi Anchor Design Software
www.tecfi.it/tads

TTR 01



Special conical washer for TT02 Woodpecker CSK head screw, GOLD yellow zinc plated (CrVI free)

- Rondelle conique en acier bichromaté (effet doré- sans CrVI), pour vis tête fraisée plate TT02 Woodpecker
- Spezialkugelscheibe für TT02 Woodpecker Senkkopfschraube, GOLD gelb (CrVI frei) verzinkt
- Arandela cónica especial de acero bicromatado (efecto dorado – libre de CrVI), para tornillos con cabeza avellanada TT02 Woodpecker
- Оцинкованная коническая шайба желтого цвета (GOLD без содержания Cr6) для шурупов с плоской потайной головкой TT02 Woodpecker

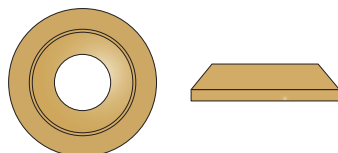

Item code	Size d x D (mm)	Pcs. per box	Pcs. per carton
For TT Ø 6 screw:			
TTR 01 07 020	7,6 x 20	200	2.400
For TT Ø 8 screw:			
TTR 01 09 025	9,5 x 25	200	1.600
For TT Ø 10 screw:			
TTR 01 11 030	11,4 x 30	200	1.000

Box / Boîte / Verpackung / Caja / Упаковка



TTR 50



A2 (AISI 304) stainless steel special conical washer for TT50 Woodpecker CSK head screw

- Rondelle conique en acier inox A2 (AISI 304) pour vis tête fraisée plate TT50 Woodpecker
- Edelstahl A2 (AISI 304) Kugelscheibe, für TT50 Woodpecker Senkkopfschrauben
- Arandela cónica especial de acero Inoxidable A2 (AISI 304), para tornillos con cabeza avellanada TT50 Woodpecker
- Коническая шайба из нержавеющей стали A2 (AISI 304) для шурупов TT50 Woodpecker

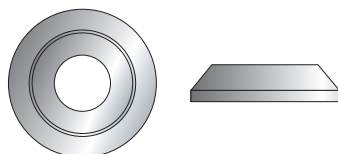

Item code	Size d x D (mm)	Pcs. per box	Pcs. per carton
For TT Ø 6 screw:			
TTR 50 07 020	7,6 x 20	200	2.000
For TT Ø 8 screw:			
TTR 50 09 025	9,5 x 25	200	2.000
For TT Ø 10 screw:			
TTR 50 11 030	11,4 x 30	200	1.000

Box / Boîte / Verpackung / Caja / Упаковка



Woodpecker®

Screws & wood accessories

SCREWS FOR STRUCTURAL TIMBER APPLICATIONS



- ▶ Excellent performances thanks to a proper combination of selected materials and the special geometry of the screw
- ▶ Patented thread and special reamer, for a quick and safe installation in the hardest wood too
- ▶ The new Tecfi "Gold type - CrVI free" coating, is the very appreciated deep yellow zinc plating, totally in compliance with REACH 1907/2006(CE) Regulation



TT-Woodpecker® screws, to be used for structural timber applications, have achieved the CE Approval, according to the European Standard EN 14592:2008+A1:2012. During the Initial Type Testing performed by accredited laboratories, TT-Woodpecker® Screws have fulfilled all requirements provided by the Standard EN 14592:2008+A1:2012.



TK 01

Flat CSK head with ribs cross type Z recess chipboard screw with special patented thread, zinc plated and waxed

- Vis à tête fraisée plate avec nervures pour panneaux de particules, empreinte cruciforme Type Z, avec filetage breveté, en acier cémenté, zinguée et cirée
- Senkkopf- Spanplattenschraube mit Fräsrippen, Kreuzschlitz Z, Gewinde patentiert, verzinkt und mit Wachs
- Tornillo para aglomerado, cabeza avellanada cruz tipo Z con estrías avellanadoras, especial rosca patentada, cincado y encerado
- Запатентованный оцинкованный шуруп по дереву из закаленной стали с плоской потайной головкой с насечками с крестообразным шлицем типа Z, со специальным восковым покрытием

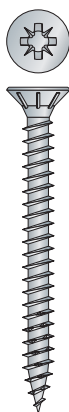

CE Certified according to the EN 14592:2008+A1:2012, for structural timber applications.

Nominal diameter and technical details in: DoP n. P1210/13-630-1-TK

Item code	Screw size Ø x L / L ₁ (mm)	Pcs. per box	Pcs. per carton
Ø 2,5 / Pz 1			
CE TK 01 25 010	2,5 x 10	500	5.000
CE TK 01 25 012	2,5 x 12	500	5.000
CE TK 01 25 016	2,5 x 16	500	5.000
CE TK 01 25 018	2,5 x 18	500	5.000
CE TK 01 25 020	2,5 x 20	500	5.000
CE TK 01 25 025	2,5 x 25	500	5.000
Ø 3 / Pz 1			
TK 01 30 010	3 x 10	500	5.000
CE TK 01 30 012	3 x 12	500	5.000
in CE TK 01 30 016	3 x 16	500	5.000
CE TK 01 30 018	3 x 18	500	5.000
in CE TK 01 30 020	3 x 20	500	5.000
in CE TK 01 30 025	3 x 25	500	5.000
in CE TK 01 30 030	3 x 30	500	5.000
in CE TK 01 30 035	3 x 35	500	5.000
CE TK 01 30 040	3 x 40	500	5.000
CE TK 01 30 045	3 x 45	500	5.000
CE TK 01 30 050	3 x 50	500	5.000
Ø 3,5 / Pz 2			
TK 01 35 012	3,5 x 12	500	5.000
in CE TK 01 35 016	3,5 x 16	500	5.000
in CE TK 01 35 018	3,5 x 18	500	5.000
in CE TK 01 35 020	3,5 x 20	500	5.000
in CE TK 01 35 025	3,5 x 25	500	5.000
in CE TK 01 35 030	3,5 x 30	500	5.000
in CE TK 01 35 035	3,5 x 35	500	5.000
in CE TK 01 35 040	3,5 x 40	500	5.000
CE TK 01 35 045	3,5 x 45	500	5.000
in CE TK 01 35 050	3,5 x 50	500	5.000
Ø 4 / Pz 2			
in CE TK 01 40 016	4 x 16	500	5.000
CE TK 01 40 018	4 x 18	500	5.000
in CE TK 01 40 020	4 x 20	500	5.000
in CE TK 01 40 025	4 x 25	500	5.000
in CE TK 01 40 030	4 x 30	500	5.000
in CE TK 01 40 035	4 x 35	500	5.000
in CE TK 01 40 040	4 x 40	500	5.000
in CE TK 01 40 045	4 x 45	200	2.000
in CE TK 01 40 050	4 x 50	200	2.000
in CE TK 01 40 060	4 x 60	200	2.000
in CE TK 01 40 070	4 x 70 / 60	200	2.000
Ø 4,5 / Pz 2			
CE TK 01 45 020	4,5 x 20	500	5.000
CE TK 01 45 025	4,5 x 25	500	5.000
in CE TK 01 45 030	4,5 x 30	500	5.000
in CE TK 01 45 035	4,5 x 35	500	5.000
in CE TK 01 45 040	4,5 x 40	500	5.000
in CE TK 01 45 045	4,5 x 45	200	2.000
in CE TK 01 45 050	4,5 x 50	200	2.000
in CE TK 01 45 060	4,5 x 60	200	2.000
CE TK 01 45 070	4,5 x 70 / 60	200	2.000
in CE TK 01 45 080	4,5 x 80 / 60	200	2.000

CE Certified / Certifié CE / CE Zulassung / Certificado CE / Сертификат CE

Fire Reaction A1 / Réaction au feu A1 / Brandverhalten A1 / Reacción al fuego A1 / Реакция на огонь A1

TK 01

Flat CSK head with ribs cross type Z recess chipboard screw with special patented thread, zinc plated and waxed

- Vis à tête fraisée plate avec nervures pour panneaux de particules, empreinte cruciforme Type Z, avec filetage breveté, en acier cémenté, zinguée et cirée
- Senkkopf- Spanplattenschraube mit Fräsrippen, Kreuzschlitz Z, Gewinde patentiert, verzinkt und mit Wachs
- Tornillo para aglomerado, cabeza avellanada cruz tipo Z con estrías avellanadoras, especial rosca patentada, cincado y encerado
- Запатентованный оцинкованный шуруп по дереву из закаленной стали с плоской потайной головкой с насечками с крестообразным шлицем типа Z, со специальным восковым покрытием

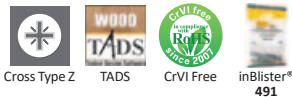
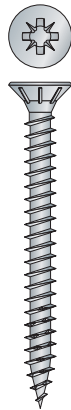

CE Certified according to the EN 14592:2008+A1:2012, for structural timber applications.
Nominal diameter and technical details in:
DoP n. P1210/13-630-1-TK

Item code	Screw size Ø x L / L ₁ (mm)	Pcs. per box	Pcs. per carton
Ø 5 / Pz 2			
CE TK 01 50 020	5 x 20	500	5.000
CE TK 01 50 025	5 x 25	500	5.000
IN CE TK 01 50 030	5 x 30	500	5.000
CE TK 01 50 035	5 x 35	500	5.000
IN CE TK 01 50 040	5 x 40	200	2.000
CE TK 01 50 045	5 x 45	200	2.000
IN CE TK 01 50 050	5 x 50	200	2.000
IN CE TK 01 50 060	5 x 60	200	2.000
IN CE TK 01 50 070	5 x 70 / 60	200	2.000
IN CE TK 01 50 080	5 x 80 / 60	200	2.000
CE TK 01 50 090	5 x 90 / 60	100	1.000
CE TK 01 50 100	5 x 100 / 60	100	1.000
CE TK 01 50 120	5 x 120 / 70	100	1.000
Ø 6 / Pz 3			
CE TK 01 60 030	6 x 30	200	2.000
IN CE TK 01 60 040	6 x 40	200	2.000
IN CE TK 01 60 050	6 x 50	200	2.000
IN CE TK 01 60 060	6 x 60	200	2.000
CE TK 01 60 070	6 x 70 / 60	200	2.000
IN CE TK 01 60 080	6 x 80 / 60	200	2.000
CE TK 01 60 090	6 x 90 / 60	100	1.000
IN CE TK 01 60 100	6 x 100 / 60	100	1.000
IN CE TK 01 60 120	6 x 120 / 70	100	1.000

CE Certified / Certifié CE / CE Zulassung / Certificado CE / Сертификат CE

Fire Reaction A1 / Réaction au feu A1 / Brandverhalten A1 / Reacción al fuego A1 / Реакция на огонь A1

Usage / Utilisation / Benutzung
Usò / Применение



Included in TADS - Tecfi Anchor Design Software for computer aided design of Anchorage.

Tecfi Anchor Design Software
www.tecfi.it/tads

DoP



Box / Boîte / Verpackung / Caja
Упаковка



TK 02

Flat CSK head with ribs cross type Z recess chipboard screw with special patented thread, GOLD yellow ZP (CrVI free) and waxed

- Vis à tête fraisée plate avec nervures pour panneaux de particules, empreinte cruciforme Type Z, avec filetage breveté, en acier cémenté, zingué jaune or (sans CrVI)
- Senkkopf- Spanplattenschraube mit Fräsrippen, Kreuzschlitz Z, Gewinde patentiert, GOLD gelb ZP (CrVI frei) verzinkt und gewachst
- Tornillo para aglomerado, cabeza avellanada cruz tipo Z con estrías avellanadoras, especial rosca patentada, bicromatado (efecto dorado - libre de CrVI) y encerado
- Запатентованный оцинкованный шуруп по дереву золотого цвета (GOLD без содержания Cr6) с плоской потайной головкой с шестигранным шлицем, со спиральной накаткой на стержне и специальным восковым покрытием

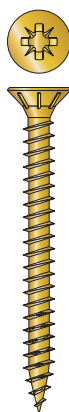

CE Certified according to the EN 14592:2008+A1:2012, for structural timber applications.

Nominal diameter and technical details in: DoP n. P1210/13-630-1-TK

Item code	Screw size Ø x L / L ₁ (mm)	Pcs. per box	Pcs. per carton
-----------	---	--------------	-----------------

Ø 2,5 - Pz 1

CE 🔥	TK 02 25 010	2,5 x 10	500	5.000
CE 🔥	TK 02 25 012	2,5 x 12	500	5.000
CE 🔥	TK 02 25 016	2,5 x 16	500	5.000
CE 🔥	TK 02 25 018	2,5 x 18	500	5.000
CE 🔥	TK 02 25 020	2,5 x 20	500	5.000
CE 🔥	TK 02 25 025	2,5 x 25	500	5.000
CE 🔥	TK 02 25 030	2,5 x 30	500	5.000

Ø 3 - Pz 1

	TK 02 30 010	3 x 10	500	5.000
CE 🔥	TK 02 30 012	3 x 12	500	5.000
in CE 🔥	TK 02 30 016	3 x 16	500	5.000
CE 🔥	TK 02 30 018	3 x 18	500	5.000
in CE 🔥	TK 02 30 020	3 x 20	500	5.000
in CE 🔥	TK 02 30 025	3 x 25	500	5.000
in CE 🔥	TK 02 30 030	3 x 30	500	5.000
in CE 🔥	TK 02 30 035	3 x 35	500	5.000
CE 🔥	TK 02 30 040	3 x 40	500	5.000
CE 🔥	TK 02 30 045	3 x 45	500	5.000
CE 🔥	TK 02 30 050	3 x 50	500	5.000

Ø 3,5 - Pz 2

	TK 02 35 012	3,5 x 12	500	5.000
in CE 🔥	TK 02 35 016	3,5 x 16	500	5.000
in CE 🔥	TK 02 35 018	3,5 x 18	500	5.000
in CE 🔥	TK 02 35 020	3,5 x 20	500	5.000
in CE 🔥	TK 02 35 025	3,5 x 25	500	5.000
in CE 🔥	TK 02 35 030	3,5 x 30	500	5.000
in CE 🔥	TK 02 35 035	3,5 x 35	500	5.000
in CE 🔥	TK 02 35 040	3,5 x 40	500	5.000
CE 🔥	TK 02 35 045	3,5 x 45	500	5.000
in CE 🔥	TK 02 35 050	3,5 x 50	500	5.000
CE 🔥	TK 02 35 060	3,5 x 60	200	2.000
CE 🔥	TK 02 35 070	3,5 x 70 / 60	200	2.000

Ø 4 - Pz 2

in CE 🔥	TK 02 40 016	4 x 16	500	5.000
CE 🔥	TK 02 40 018	4 x 18	500	5.000
in CE 🔥	TK 02 40 020	4 x 20	500	5.000
in CE 🔥	TK 02 40 025	4 x 25	500	5.000
in CE 🔥	TK 02 40 030	4 x 30	500	5.000
in CE 🔥	TK 02 40 035	4 x 35	500	5.000
in CE 🔥	TK 02 40 040	4 x 40	500	5.000
in CE 🔥	TK 02 40 045	4 x 45	200	2.000
in CE 🔥	TK 02 40 050	4 x 50	200	2.000
in CE 🔥	TK 02 40 060	4 x 60	200	2.000
in CE 🔥	TK 02 40 070	4 x 70 / 60	200	2.000

CE Certified / Certifié CE / CE Zulassung / Certificado CE / Сертификат CE

Fire Reaction A1 / Réaction au feu A1 / Brandverhalten A1 / Reacción al fuego A1 / Реакция на огонь A1

TK 02

Flat CSK head with ribs cross type Z recess chipboard screw with special patented thread, GOLD yellow ZP (CrVI free) and waxed

- Vis à tête fraisée plate avec nervures pour panneaux de particules, empreinte cruciforme Type Z, avec filetage breveté, en acier cémenté, zingué jaune or (sans CrVI)
- Senkkopf- Spanplattenschraube mit Fräsrippen, Kreuzschlitz Z, Gewinde patentiert, GOLD gelb ZP (CrVI frei) verzinkt und gewachst
- Tornillo para aglomerado, cabeza avellanada cruz tipo Z con estrías avellanadoras, especial rosca patentada, bicromatado (efecto dorado - libre de CrVI) y encerado
- Запатентованный оцинкованный шуруп по дереву золотого цвета (GOLD без содержания Cr6) с плоской потайной головкой с шестигранным шлицем, со спиральной накаткой на стержне и специальным восковым покрытием

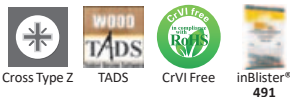
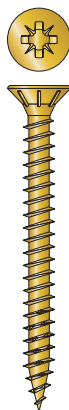

CE Certified according to the EN 14592:2008+A1:2012, for structural timber applications.
Nominal diameter and technical details in:
DoP n. P1210/13-630-1-TK

Item code	Screw size Ø x L / L ₁ (mm)	Pcs. per box	Pcs. per carton
Ø 4,5 - Pz 2			
CE TK 02 45 020	4,5 x 20	500	5.000
CE TK 02 45 025	4,5 x 25	500	5.000
in CE TK 02 45 030	4,5 x 30	500	5.000
in CE TK 02 45 035	4,5 x 35	500	5.000
in CE TK 02 45 040	4,5 x 40	500	5.000
in CE TK 02 45 045	4,5 x 45	200	2.000
in CE TK 02 45 050	4,5 x 50	200	2.000
in CE TK 02 45 060	4,5 x 60	200	2.000
CE TK 02 45 070	4,5 x 70 / 60	200	2.000
in CE TK 02 45 080	4,5 x 80 / 60	200	2.000
Ø 5 / Pz 2			
CE TK 02 50 020	5 x 20	500	5.000
CE TK 02 50 025	5 x 25	500	5.000
in CE TK 02 50 030	5 x 30	500	5.000
CE TK 02 50 035	5 x 35	500	5.000
in CE TK 02 50 040	5 x 40	200	2.000
CE TK 02 50 045	5 x 45	200	2.000
in CE TK 02 50 050	5 x 50	200	2.000
in CE TK 02 50 060	5 x 60	200	2.000
in CE TK 02 50 070	5 x 70 / 60	200	2.000
in CE TK 02 50 080	5 x 80 / 60	200	2.000
CE TK 02 50 090	5 x 90 / 60	100	1.000
CE TK 02 50 100	5 x 100 / 60	100	1.000
CE TK 02 50 110	5 x 110 / 70	100	1.000
Ø 6 / Pz 3			
CE TK 02 60 030	6 x 30	200	2.000
in CE TK 02 60 040	6 x 40	200	2.000
in CE TK 02 60 050	6 x 50	200	2.000
in CE TK 02 60 060	6 x 60	200	2.000
CE TK 02 60 070	6 x 70 / 60	200	2.000
in CE TK 02 60 080	6 x 80 / 60	200	2.000
CE TK 02 60 090	6 x 90 / 60	100	1.000
in CE TK 02 60 100	6 x 100 / 60	100	1.000

CE CE Certified / Certifié CE / CE Zulassung / Certificado CE / Сертификат CE
 Fire Reaction A1 / Réaction au feu A1 / Brandverhalten A1 / Reacción al fuego A1 / Реакция на огонь A1

"Gold type - CrVI free" special coating



The new Tecfi "Gold type - CrVI free" coating, is a very appreciated deep yellow zinc plating, totally in compliance with REACH Regulation. For more info, please see technical introduction on page 15.

Usage / Utilisation / Benutzung
 Uso / Применение



Tecfi Anchor Design Software
www.tecfi.it/tads

DoP



Box / Boîte / Verpackung / Caja
 Упаковка



TK 03

Flat CSK head with ribs cross type Z recess chipboard screw with special patented thread, brass plated and waxed

- Vis à tête fraisée plate avec nervures pour panneaux de particules, empreinte cruciforme Type Z, avec filetage breveté, en acier cémenté, laitonnée et cirée
- Senkkopf- Spanplattenschraube mit Fräsrippen, Kreuzschlitz Z, Gewinde patentiert, vermessingt und mit Wachs
- Tornillo para aglomerado, cabeza avellanada cruz tipo Z con estrías avellanadoras, especial rosca patentada, latonado y encerado
- Запатентованный латунный шуруп по дереву из закаленной стали с плоской потайной головкой с насечками с крестообразным шлицем типа Z, со специальным восковым покрытием

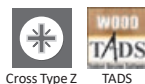
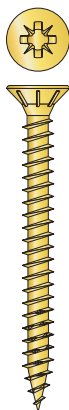

CE Certified according to the EN 14592:2008+A1:2012, for structural timber applications.
Nominal diameter and technical details in:
DoP n. P1210/13-630-1-TK

Item code	Screw size Ø x L / L ₁ (mm)	Pcs. per box	Pcs. per carton
Ø 2,5 / Pz 1			
CE TK 03 25 010	2,5 x 10	500	5.000
CE TK 03 25 012	2,5 x 12	500	5.000
CE TK 03 25 016	2,5 x 16	500	5.000
CE TK 03 25 020	2,5 x 20	500	5.000
CE TK 03 25 025	2,5 x 25	500	5.000
CE TK 03 25 030	2,5 x 30	500	5.000
Ø 3 / Pz 1			
CE TK 03 30 016	3 x 16	500	5.000
CE TK 03 30 020	3 x 20	500	5.000
CE TK 03 30 025	3 x 25	500	5.000
CE TK 03 30 030	3 x 30	500	5.000
CE TK 03 30 035	3 x 35	500	5.000
CE TK 03 30 040	3 x 40	500	5.000
Ø 3,5 / Pz 2			
CE TK 03 35 016	3,5 x 16	500	5.000
CE TK 03 35 020	3,5 x 20	500	5.000
CE TK 03 35 025	3,5 x 25	500	5.000
CE TK 03 35 030	3,5 x 30	500	5.000
CE TK 03 35 035	3,5 x 35	500	5.000
CE TK 03 35 040	3,5 x 40	500	5.000
CE TK 03 35 050	3,5 x 50	500	5.000
Ø 4 / Pz 2			
CE TK 03 40 016	4 x 16	500	5.000
CE TK 03 40 020	4 x 20	500	5.000
CE TK 03 40 025	4 x 25	500	5.000
CE TK 03 40 030	4 x 30	500	5.000
CE TK 03 40 035	4 x 35	500	5.000
CE TK 03 40 040	4 x 40	500	5.000
CE TK 03 40 045	4 x 45	200	2.000
CE TK 03 40 050	4 x 50	200	2.000
CE TK 03 40 060	4 x 60	200	2.000
CE TK 03 40 070	4 x 70 / 60	200	2.000
Ø 4,5 / Pz 2			
CE TK 03 45 020	4,5 x 20	500	5.000
CE TK 03 45 025	4,5 x 25	500	5.000
CE TK 03 45 030	4,5 x 30	500	5.000
CE TK 03 45 035	4,5 x 35	500	5.000
CE TK 03 45 040	4,5 x 40	500	5.000
CE TK 03 45 045	4,5 x 45	200	2.000
CE TK 03 45 050	4,5 x 50	200	2.000
CE TK 03 45 060	4,5 x 60	200	2.000
CE TK 03 45 070	4,5 x 70 / 60	200	2.000

CE Certified / Certifié CE / CE Zulassung / Certificado CE / Сертификат CE >>>
Fire Reaction A1 / Réaction au feu A1 / Brandverhalten A1 / Reacción al fuego A1 / Реакция на огонь A1

TK 03

Flat CSK head with ribs cross type Z recess chipboard screw with special patented thread, brass plated and waxed

- Vis à tête fraisée plate avec nervures pour panneaux de particules, empreinte cruciforme Type Z, avec filetage breveté, en acier cémenté, laitonée et cirée
- Senkkopf- Spanplattenschraube mit Fräsrippen, Kreuzschlitz Z, Gewinde patentiert, vermessingt und mit Wachs
- Tornillo para aglomerado, cabeza avellanada cruz tipo Z con estrías avellanadoras, especial rosca patentada, latonado y encerado
- Запатентованный латунный шуруп по дереву из закаленной стали с плоской потайной головкой с насечками с крестообразным шлицем типа Z, со специальным восковым покрытием

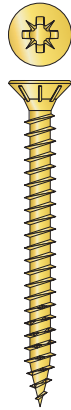

CE Certified according to the EN 14592:2008+A1:2012, for structural timber applications.
Nominal diameter and technical details in:
DoP n. P1210/13-630-1-TK

Item code	Screw size Ø x L / L ₁ (mm)	Pcs. per box	Pcs. per carton
Ø 5 / Pz 2			
CE TK 03 50 020	5 x 20	500	5.000
CE TK 03 50 030	5 x 30	500	5.000
CE TK 03 50 035	5 x 35	500	5.000
CE TK 03 50 040	5 x 40	200	2.000
CE TK 03 50 045	5 x 45	200	2.000
CE TK 03 50 050	5 x 50	200	2.000
CE TK 03 50 060	5 x 60	200	2.000
CE TK 03 50 070	5 x 70 / 60	200	2.000
CE TK 03 50 080	5 x 80 / 60	200	2.000
CE TK 03 50 090	5 x 90 / 60	100	1.000
CE TK 03 50 100	5 x 100 / 60	100	1.000
CE TK 03 50 110	5 x 110 / 70	100	1.000
Ø 6 / Pz 3			
CE TK 03 60 030	6 x 30	200	2.000
CE TK 03 60 040	6 x 40	200	2.000
CE TK 03 60 050	6 x 50	200	2.000
CE TK 03 60 060	6 x 60	200	2.000
CE TK 03 60 070	6 x 70 / 60	200	2.000
CE TK 03 60 080	6 x 80 / 60	200	2.000
CE TK 03 60 090	6 x 90 / 60	100	1.000
CE TK 03 60 100	6 x 100 / 60	100	1.000
CE TK 03 60 110	6 x 110 / 70	100	1.000
CE TK 03 60 120	6 x 120 / 70	100	1.000
CE TK 03 60 140	6 x 140 / 70	100	1.000

CE Certified / Certifié CE / CE Zulassung / Certificado CE / Сертификат CE
 Fire Reaction A1 / Réaction au feu A1 / Brandverhalten A1 / Reacción al fuego A1 / Реакция на огонь A1

Usage / Utilisation / Benutzung
 Uso / Применение



Included in TADS - Tecfi Anchor Design Software for computer aided design of Anchorage.

Tecfi Anchor Design Software
www.tecfi.it/tads

DoP



Box / Boîte / Verpackung / Caja
 Упаковка



TK 04

Flat CSK head with ribs cross type Z recess chipboard screw with special patented thread, bronze plated and waxed

- Vis à tête fraisée plate avec nervures pour panneaux de particules, empreinte cruciforme Type Z, avec filetage breveté, en acier cémenté, bronzée et cirée
- Senkkopf- Spanplattenschraube mit Fräsrippen, Kreuzschlitz Z, Gewinde patentiert, bronziert und mit Wachs
- Tornillo para aglomerado, cabeza avellanada cruz tipo Z con estrías avellanadoras, especial rosca patentada, bronceado y encerado
- Запатентованный бронзовый шуруп по дереву с плоской потайной головкой с насечками с крестообразным шлицем типа Z под головкой из закаленной стали, со специальным восковым покрытием

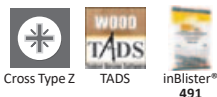
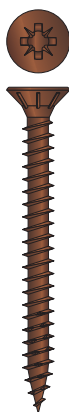

CE Certified according to the EN 14592:2008+A1:2012, for structural timber applications.
Nominal diameter and technical details in:
DoP n. P1210/13-630-1-TK

Item code	Screw size Ø x L / L ₁ (mm)	Pcs. per box	Pcs. per carton
Ø 2,5 / Pz 1			
CE TK 04 25 010	2,5 x 10	500	5.000
CE TK 04 25 012	2,5 x 12	500	5.000
CE TK 04 25 016	2,5 x 16	500	5.000
CE TK 04 25 018	2,5 x 18	500	5.000
CE TK 04 25 020	2,5 x 20	500	5.000
CE TK 04 25 025	2,5 x 25	500	5.000
CE TK 04 25 030	2,5 x 30	500	5.000
Ø 3 / Pz 1			
TK 04 30 010	3 x 10	500	5.000
CE TK 04 30 012	3 x 12	500	5.000
in CE TK 04 30 016	3 x 16	500	5.000
CE TK 04 30 018	3 x 18	500	5.000
in CE TK 04 30 020	3 x 20	500	5.000
in CE TK 04 30 025	3 x 25	500	5.000
in CE TK 04 30 030	3 x 30	500	5.000
in CE TK 04 30 035	3 x 35	500	5.000
CE TK 04 30 040	3 x 40	500	5.000
CE TK 04 30 045	3 x 45	500	5.000
Ø 3,5 / Pz 2			
in CE TK 04 35 016	3,5 x 16	500	5.000
in CE TK 04 35 018	3,5 x 18	500	5.000
in CE TK 04 35 020	3,5 x 20	500	5.000
in CE TK 04 35 025	3,5 x 25	500	5.000
in CE TK 04 35 030	3,5 x 30	500	5.000
in CE TK 04 35 035	3,5 x 35	500	5.000
in CE TK 04 35 040	3,5 x 40	500	5.000
CE TK 04 35 045	3,5 x 45	500	5.000
in CE TK 04 35 050	3,5 x 50	500	5.000
Ø 4 / Pz 2			
in CE TK 04 40 016	4 x 16	500	5.000
CE TK 04 40 018	4 x 18	500	5.000
in CE TK 04 40 020	4 x 20	500	5.000
in CE TK 04 40 025	4 x 25	500	5.000
in CE TK 04 40 030	4 x 30	500	5.000
in CE TK 04 40 035	4 x 35	500	5.000
in CE TK 04 40 040	4 x 40	500	5.000
in CE TK 04 40 045	4 x 45	200	2.000
in CE TK 04 40 050	4 x 50	200	2.000
in CE TK 04 40 060	4 x 60	200	2.000
in CE TK 04 40 070	4 x 70 / 60	200	2.000
CE TK 04 40 080	4 x 80 / 60	200	2.000
Ø 4,5 / Pz 2			
CE TK 04 45 020	4,5 x 20	500	5.000
CE TK 04 45 025	4,5 x 25	500	5.000
in CE TK 04 45 030	4,5 x 30	500	5.000
in CE TK 04 45 035	4,5 x 35	500	5.000
in CE TK 04 45 040	4,5 x 40	500	5.000
in CE TK 04 45 045	4,5 x 45	200	2.000
in CE TK 04 45 050	4,5 x 50	200	2.000
in CE TK 04 45 060	4,5 x 60	200	2.000
CE TK 04 45 070	4,5 x 70 / 60	200	2.000
in CE TK 04 45 080	4,5 x 80 / 60	200	2.000

CE CE Certified / Certifié CE / CE Zulassung / Certificado CE / Сертификат CE >>>

Fire Reaction A1 / Réaction au feu A1 / Brandverhalten A1 / Reacción al fuego A1 / Реакция на огонь A1

TK 04

Flat CSK head with ribs cross type Z recess chipboard screw with special patented thread, bronze plated and waxed

- Vis à tête fraisée plate avec nervures pour panneaux de particules, empreinte cruciforme Type Z, avec filetage breveté, en acier cémenté, bronzée et cirée
- Senkkopf- Spanplattenschraube mit Fräsrippen, Kreuzschlitz Z, Gewinde patentiert, bronziert und mit Wachs
- Tornillo para aglomerado, cabeza avellanada cruz tipo Z con estrías avellanadoras, especial rosca patentada, bronceado y encerado
- Запатентованный бронзовый шуруп по дереву с плоской потайной головкой с насечками с крестообразным шлицем типа Z под головкой из закаленной стали, со специальным восковым покрытием

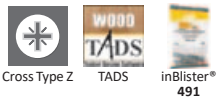
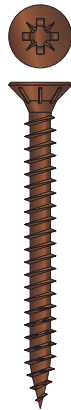

CE Certified according to the EN 14592:2008+A1:2012, for structural timber applications.
Nominal diameter and technical details in:
DoP n. P1210/13-630-1-TK

Item code	Screw size Ø x L / L ₁ (mm)	Pcs. per box	Pcs. per carton
Ø 5 / Pz 2			
CE TK 04 50 020	5 x 20	500	5.000
CE TK 04 50 025	5 x 25	500	5.000
in CE TK 04 50 030	5 x 30	500	5.000
CE TK 04 50 035	5 x 35	500	5.000
in CE TK 04 50 040	5 x 40	200	2.000
CE TK 04 50 045	5 x 45	200	2.000
in CE TK 04 50 050	5 x 50	200	2.000
in CE TK 04 50 060	5 x 60	200	2.000
in CE TK 04 50 070	5 x 70 / 60	200	2.000
in CE TK 04 50 080	5 x 80 / 60	200	2.000
CE TK 04 50 090	5 x 90 / 60	100	1.000
CE TK 04 50 100	5 x 100 / 60	100	1.000
CE TK 04 50 120	5 x 120 / 70	100	1.000

Ø 6 / Pz 3			
in CE TK 04 60 040	6 x 40	200	2.000
in CE TK 04 60 050	6 x 50	200	2.000
in CE TK 04 60 060	6 x 60	200	2.000
CE TK 04 60 070	6 x 70 / 60	200	2.000
in CE TK 04 60 080	6 x 80 / 60	200	2.000
CE TK 04 60 090	6 x 90 / 60	100	1.000
in CE TK 04 60 100	6 x 100 / 60	100	1.000
CE TK 04 60 110	6 x 110 / 70	100	1.000
in CE TK 04 60 120	6 x 120 / 70	100	1.000
CE TK 04 60 130	6 x 130 / 70	100	1.000
CE TK 04 60 140	6 x 140 / 70	100	1.000
CE TK 04 60 150	6 x 150 / 70	100	1.000
CE TK 04 60 160	6 x 160 / 70	100	1.000
CE TK 04 60 180	6 x 180 / 70	100	1.000
CE TK 04 60 200	6 x 200 / 70	100	1.000

CE CE Certified / Certifié CE / CE Zulassung / Certificado CE / Сертификат CE
 Fire Reaction A1 / Réaction au feu A1 / Brandverhalten A1 / Reacción al fuego A1 / Реакция на огонь A1

Usage / Utilisation / Benutzung
 Uso / Применение



Included in TADS - Tecfi Anchor Design Software for computer aided design of Anchorage.

Tecfi Anchor Design Software
www.tecfi.it/tads

DoP



Box / Boîte / Verpackung / Caja
 Упаковка



TF 01 ^{NEW}

- 🇬🇧 **Flat CSK head with ribs cross type Z recess chipboard screw, with special patented thread (partial thread), zinc plated and waxed**
- 🇫🇷 Vis à tête fraisée plate avec nervures pour panneaux de particules, empreinte cruciforme Type Z, avec filetage breveté partiel, en acier cémenté, zinguée et cirée
- 🇩🇪 Senkkopf- Spanplattenschraube mit Fräsrippen, Kreuzschlitz Z, Teilgewinde patentiert, verzinkt und gewachst
- 🇪🇸 Tornillo para aglomerado, cabeza avellanada cruz tipo Z con estrías avellanadoras, especial rosca parcial patentada, cincado y encerado
- 🇷🇺 Оцинкованный шуруп по ДСП с плоской потайной головкой со специальной запатентованной резьбой (частичная резьба) из закаленной стали с крестообразным шлицем типа Z, со специальным восковым покрытием

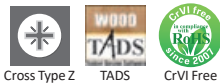
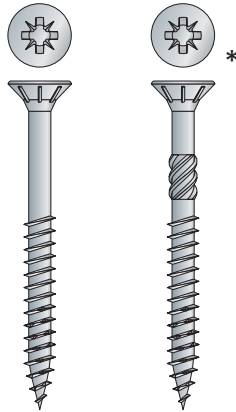

- ✂️ * With reamer starting from 50 mm length (Ø 4 mm)
- 🇫🇷 * Avec alésoir à partir de la longueur 50 mm (Ø 4 mm)
- 🇩🇪 * Mit Reibahle von der Länge 50 mm (Ø 4 mm)
- 🇪🇸 * Con fresa a partir de la largueza 50 mm (Ø 4 mm)
- 🇷🇺 * С накаткой для размера 50 мм и выше (Ø 4 мм)



CE Certified according to the EN 14592:2008+A1:2012, for structural timber applications. Nominal diameter and technical details in: DoP n. TF/19-001

DoP



One bit free per box



- ✂️ **one bit free per box**
- 🇫🇷 Un embout gratuit dans chaque boîte
- 🇩🇪 Zu jeder Verpackung ein Bit kostenlos
- 🇪🇸 Una punta de atornillar en cada caja
- 🇷🇺 Один бесплатный бит в каждой упаковке

Box / Boîte / Verpackung
Caja / Упаковка

Usage / Utilisation / Benutzung
Uso / Применение



Included in TADS - Tecfi Anchor Design Software for computer aided design of Anchorage.

Tecfi Anchor Design Software
www.tecfi.it/tads

Item code	Screw size Ø x L / L ₁ (mm)	Pcs. per box	Pcs. per carton
Ø 3,5 / Pz 2			
CE TF 01 35 030	3,5 x 30 / 18	500	5.000
CE TF 01 35 035	3,5 x 35 / 21	500	5.000
CE TF 01 35 040	3,5 x 40 / 25	500	5.000
CE TF 01 35 045	3,5 x 45 / 28	500	5.000
CE TF 01 35 050	3,5 x 50 / 30	500	5.000
Ø 4 / Pz 2			
CE TF 01 40 030	4,0 x 30 / 18	500	5.000
CE TF 01 40 035	4,0 x 35 / 21	500	5.000
CE TF 01 40 040	4,0 x 40 / 25	500	5.000
CE TF 01 40 045	4,0 x 45 / 28	200	2.000
CE TF 01 40 050	4,0 x 50 / 30	200	2.000
CE TF 01 40 060	4,0 x 60 / 35	200	2.000
CE TF 01 40 070	4,0 x 70 / 45	200	2.000
CE TF 01 40 080	4,0 x 80 / 48	200	2.000
Ø 4,5 / Pz 2			
CE TF 01 45 035	4,5 x 35 / 21	500	5.000
CE TF 01 45 040	4,5 x 40 / 25	500	5.000
CE TF 01 45 045	4,5 x 45 / 28	200	2.000
CE TF 01 45 050	4,5 x 50 / 30	200	2.000
CE TF 01 45 060	4,5 x 60 / 35	200	2.000
CE TF 01 45 070	4,5 x 70 / 45	200	2.000
CE TF 01 45 080	4,5 x 80 / 48	200	2.000
CE TF 01 45 100	4,5 x 100 / 60	100	1.000
Ø 5 / Pz 2			
CE TF 01 50 040	5 x 40 / 25	200	2.000
CE TF 01 50 045	5 x 45 / 28	200	2.000
CE TF 01 50 050	5 x 50 / 30	200	2.000
CE TF 01 50 060	5 x 60 / 35	200	2.000
CE TF 01 50 070	5 x 70 / 45	200	2.000
CE TF 01 50 080	5 x 80 / 48	200	2.000
CE TF 01 50 090	5 x 90 / 48	100	1.000
CE TF 01 50 100	5 x 100 / 60	100	1.000
CE TF 01 50 120	5 x 120 / 70	100	1.000
CE TF 01 50 140	5 x 140 / 70	100	1.000
Ø 6 / Pz 3			
CE TF 01 60 050	6 x 50 / 30	200	2.000
CE TF 01 60 060	6 x 60 / 35	200	2.000
CE TF 01 60 070	6 x 70 / 45	200	2.000
CE TF 01 60 080	6 x 80 / 48	100	1.000
CE TF 01 60 100	6 x 100 / 60	100	1.000
CE TF 01 60 120	6 x 120 / 70	100	1.000
CE TF 01 60 140	6 x 140 / 70	100	1.000
CE TF 01 60 160	6 x 160 / 70	100	1.000
CE TF 01 60 180	6 x 180 / 70	100	1.000
CE TF 01 60 200	6 x 200 / 70	100	1.000

CE Certified / Certifié CE / CE Zulassung / Certificado CE / Сертификат CE
 Fire Reaction A1 / Réaction au feu A1 / Brandverhalten A1 / Reacción al fuego A1 / Реакция на огонь A1

TF 02 ^{NEW}

✳️ **Flat CSK head with ribs cross type Z recess chipboard screw with special patented thread (partial thread), GOLD yellow ZP (CrVI free) and waxed**

- 🇫🇷 Vis à tête fraisée plate avec nervures pour panneaux de particules, empreinte cruciforme Type Z, avec filetage breveté partiel, en acier cémenté, zingué jaune or (sans CrVI) et cirée
- 🇩🇪 Senkkopf- Spanplattenschraube mit Fräsrippen, Kreuzschlitz Z, Teilgewinde patentiert, GOLD gelb ZP (CrVI frei) verzinkt und gewachst
- 🇪🇸 Tornillo para aglomerado, cabeza avellanada cruz tipo Z con estrías avellanadoras, especial rosca parcial patentada, bicromatado (efecto dorado – libre de CrVI) y encerado
- 🇷🇺 Оцинкованный шуруп по ДСП золотого цвета (GOLD без содержания Cr6) с плоской потайной головкой со специальной запатентованной резьбой (частичная резьба) из закаленной стали с крестообразным шлицем типа Z, со специальным восковым покрытием

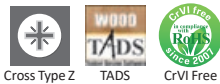
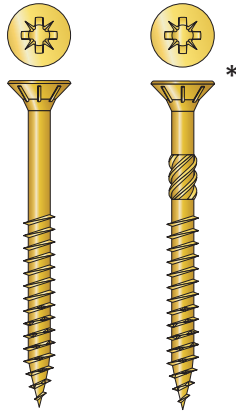

- ✳️ * With reamer starting from 50 mm length (Ø 4 mm)
- 🇫🇷 * Avec alésoir à partir de la longueur 50 mm (Ø 4 mm)
- 🇩🇪 * Mit Reibahle von der Länge 50 mm (Ø 4 mm)
- 🇪🇸 * Con fresa a partir de la largueza 50 mm (Ø 4 mm)
- 🇷🇺 * С накаткой для размера 50 мм и выше (Ø 4 мм)



CE Certified according to the EN 14592:2008+A1:2012, for structural timber applications. Nominal diameter and technical details in: DoP n. TF/19-001

DoP



“Gold type - CrVI free” special coating



The new Tecfi “Gold type - CrVI free” coating, is a very appreciated deep yellow zinc plating, totally in compliance with REACH Regulation. For more info, please see technical introduction on page 15.

One bit free per box



- ✳️ **one bit free per box**
- 🇫🇷 Un embout gratuit dans chaque boîte
- 🇩🇪 Zu jeder Verpackung ein Bit kostenlos
- 🇪🇸 Una punta de atornillar en cada caja
- 🇷🇺 Один бесплатный бит в каждой упаковке

Box / Boîte / Verpackung
Caja / Упаковка

Usage / Utilisation / Benutzung
Uso / Применение



Included in TADS - Tecfi Anchor Design Software for computer aided design of Anchorage.

Tecfi Anchor Design Software
www.tecfi.it/tads

Item code	Screw size Ø x L / L ₁ (mm)	Pcs. per box	Pcs. per carton
Ø 3,5 / Pz 2			
CE TF 02 35 030	3,5 x 30 / 18	500	5.000
CE TF 02 35 035	3,5 x 35 / 21	500	5.000
CE TF 02 35 040	3,5 x 40 / 25	500	5.000
CE TF 02 35 045	3,5 x 45 / 28	500	5.000
CE TF 02 35 050	3,5 x 50 / 30	500	5.000
Ø 4 / Pz 2			
CE TF 02 40 030	4,0 x 30 / 18	500	5.000
CE TF 02 40 035	4,0 x 35 / 21	500	5.000
CE TF 02 40 040	4,0 x 40 / 25	500	5.000
CE TF 02 40 045	4,0 x 45 / 28	200	2.000
CE TF 02 40 050	4,0 x 50 / 30	200	2.000
CE TF 02 40 060	4,0 x 60 / 35	200	2.000
CE TF 02 40 070	4,0 x 70 / 45	200	2.000
CE TF 02 40 080	4,0 x 80 / 48	200	2.000
Ø 4,5 / Pz 2			
CE TF 02 45 035	4,5 x 35 / 21	500	5.000
CE TF 02 45 040	4,5 x 40 / 25	500	5.000
CE TF 02 45 045	4,5 x 45 / 28	200	2.000
CE TF 02 45 050	4,5 x 50 / 30	200	2.000
CE TF 02 45 060	4,5 x 60 / 35	200	2.000
CE TF 02 45 070	4,5 x 70 / 45	200	2.000
CE TF 02 45 080	4,5 x 80 / 48	200	2.000
CE TF 02 45 100	4,5 x 100 / 60	100	1.000
Ø 5 / Pz 2			
CE TF 02 50 040	5 x 40 / 25	200	2.000
CE TF 02 50 045	5 x 45 / 28	200	2.000
CE TF 02 50 050	5 x 50 / 30	200	2.000
CE TF 02 50 060	5 x 60 / 35	200	2.000
CE TF 02 50 070	5 x 70 / 45	200	2.000
CE TF 02 50 080	5 x 80 / 48	200	2.000
CE TF 02 50 090	5 x 90 / 48	100	1.000
CE TF 02 50 100	5 x 100 / 60	100	1.000
CE TF 02 50 120	5 x 120 / 70	100	1.000
CE TF 02 50 140	5 x 140 / 70	100	1.000
Ø 6 / Pz 3			
CE TF 02 60 050	6 x 50 / 30	200	2.000
CE TF 02 60 060	6 x 60 / 35	200	2.000
CE TF 02 60 070	6 x 70 / 45	200	2.000
CE TF 02 60 080	6 x 80 / 48	100	1.000
CE TF 02 60 100	6 x 100 / 60	100	1.000
CE TF 02 60 120	6 x 120 / 70	100	1.000
CE TF 02 60 140	6 x 140 / 70	100	1.000
CE TF 02 60 160	6 x 160 / 70	100	1.000
CE TF 02 60 180	6 x 180 / 70	100	1.000
CE TF 02 60 200	6 x 200 / 70	100	1.000

CE CE Certified / Certifié CE / CE Zulassung / Certificado CE / Сертификат CE

🔥 Fire Reaction A1 / Réaction au feu A1 / Brandverhalten A1 / Reacción al fuego A1 / Реакция на огонь A1

TF 04 ^{NEW}

- 🇬🇧 **Flat CSK head with ribs cross type Z recess chipboard screw, with special patented thread (partial thread), bronze plated and waxed**
- 🇫🇷 Vis à tête fraisée plate avec nervures pour panneaux de particules, empreinte cruciforme Type Z, avec filetage breveté partiel, en acier cémenté, bronzée et cirée
- 🇩🇪 Senkkopf- Spanplattenschraube mit Fräsrippen, Kreuzschlitz Z, Teilgewinde patentiert, bronziert und gewachst
- 🇪🇸 Tornillo para aglomerado, cabeza avellanada cruz tipo Z con estrías avellanadoras, especial rosca parcial patentada, bronceado y encerado
- 🇷🇺 Бронзовый шуруп по ДСП с плоской потайной головкой со специальной запатентованной резьбой (частичная резьба) из закаленной стали с крестообразным шлицем типа Z, со специальным восковым покрытием

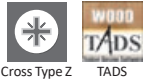
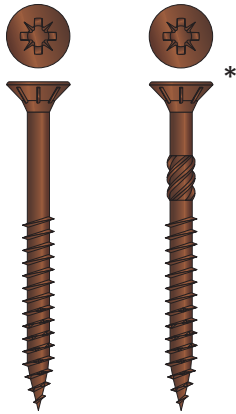

- * With reamer starting from 50 mm length (Ø 4 mm)
- 🇫🇷 * Avec alésoir à partir de la longueur 50 mm (Ø 4 mm)
- 🇩🇪 * Mit Reibahle von der Länge 50 mm (Ø 4 mm)
- 🇪🇸 * Con fresa a partir de la largueza 50 mm (Ø 4 mm)
- 🇷🇺 * С накаткой для размера 50 мм и выше (Ø 4 mm)



CE Certified according to the EN 14592:2008+A1:2012, for structural timber applications. Nominal diameter and technical details in: DoP n. TF/19-001

DoP



One bit free per box



- 🇬🇧 **one bit free per box**
- 🇫🇷 Un embout gratuit dans chaque boîte
- 🇩🇪 Zu jeder Verpackung ein Bit kostenlos
- 🇪🇸 Una punta de atornillar en cada caja
- 🇷🇺 Один бесплатный бит в каждой упаковке

Box / Boîte / Verpackung
Caja / УпаковкаUsage / Utilisation / Benutzung
Uso / Применение

Included in TADS - Tecfi Anchor Design Software for computer aided design of Anchorage.

Tecfi Anchor Design Software
www.tecfi.it/tads

Item code	Screw size Ø x L / L ₁ (mm)	Pcs. per box	Pcs. per carton
Ø 3,5 / Pz 2			
CE TF 04 35 030	3,5 x 30 / 18	500	5.000
CE TF 04 35 035	3,5 x 35 / 21	500	5.000
CE TF 04 35 040	3,5 x 40 / 25	500	5.000
CE TF 04 35 045	3,5 x 45 / 28	500	5.000
CE TF 04 35 050	3,5 x 50 / 30	500	5.000
Ø 4 / Pz 2			
CE TF 04 40 030	4,0 x 30 / 18	500	5.000
CE TF 04 40 035	4,0 x 35 / 21	500	5.000
CE TF 04 40 040	4,0 x 40 / 25	500	5.000
CE TF 04 40 045	4,0 x 45 / 28	200	2.000
CE TF 04 40 050	4,0 x 50 / 30	200	2.000
CE TF 04 40 060	4,0 x 60 / 35	200	2.000
CE TF 04 40 070	4,0 x 70 / 45	200	2.000
CE TF 04 40 080	4,0 x 80 / 48	200	2.000
Ø 4,5 / Pz 2			
CE TF 04 45 035	4,5 x 35 / 21	500	5.000
CE TF 04 45 040	4,5 x 40 / 25	500	5.000
CE TF 04 45 045	4,5 x 45 / 28	200	2.000
CE TF 04 45 050	4,5 x 50 / 30	200	2.000
CE TF 04 45 060	4,5 x 60 / 35	200	2.000
CE TF 04 45 070	4,5 x 70 / 45	200	2.000
CE TF 04 45 080	4,5 x 80 / 48	200	2.000
CE TF 04 45 100	4,5 x 100 / 60	100	1.000
Ø 5 / Pz 2			
CE TF 04 50 040	5 x 40 / 25	200	2.000
CE TF 04 50 045	5 x 45 / 28	200	2.000
CE TF 04 50 050	5 x 50 / 30	200	2.000
CE TF 04 50 060	5 x 60 / 35	200	2.000
CE TF 04 50 070	5 x 70 / 45	200	2.000
CE TF 04 50 080	5 x 80 / 48	200	2.000
CE TF 04 50 090	5 x 90 / 48	100	1.000
CE TF 04 50 100	5 x 100 / 60	100	1.000
CE TF 04 50 120	5 x 120 / 70	100	1.000
CE TF 04 50 140	5 x 140 / 70	100	1.000
Ø 6 / Pz 3			
CE TF 04 60 050	6 x 50 / 30	200	2.000
CE TF 04 60 060	6 x 60 / 35	200	2.000
CE TF 04 60 070	6 x 70 / 45	200	2.000
CE TF 04 60 080	6 x 80 / 48	100	1.000
CE TF 04 60 100	6 x 100 / 60	100	1.000
CE TF 04 60 120	6 x 120 / 70	100	1.000
CE TF 04 60 140	6 x 140 / 70	100	1.000
CE TF 04 60 160	6 x 160 / 70	100	1.000
CE TF 04 60 180	6 x 180 / 70	100	1.000
CE TF 04 60 200	6 x 200 / 70	100	1.000

CE Certified / Certifié CE / CE Zulassung / Certificado CE / Сертификат CE

Fire Reaction A1 / Réaction au feu A1 / Brandverhalten A1 / Reacción al fuego A1 / Реакция на огонь A1

Woodpecker®

Screws & wood accessories

More than **1.000** screws
for wood carpentry,
in **STEEL** and **STAINLESS STEEL**,
CE CERTIFIED

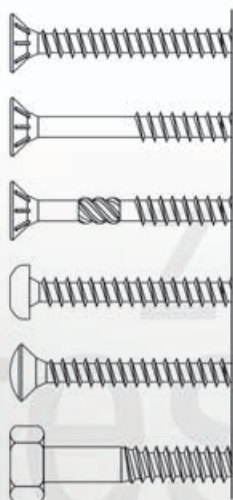

- ▶ CE certified according to EN 14592
- ▶ Patented thread for a quick, easy and safe installation even in the hardest woods and close to edges
- ▶ Coatings: zinc plated
yellow zinc plated "Gold type - CrVI free"
black zinc plated
bronze plated
brassed
- ▶ CSK head, Pan head, Raised (oval) CSK head, Hex head with partial thread or full threaded
- ▶ Wide and deep range: from $\varnothing 2,5$ to $\varnothing 12$ mm



TJ 01

Flat CSK head with ribs 6-lobe recess chipboard screw with reamer and special patented thread, zinc plated and waxed

- 🇫🇷 Vis à tête fraisée plate avec nervures pour panneaux de particules, empreinte six lobes X, avec filetage breveté, en acier cémenté, zinguée et cirée
- 🇩🇪 Senkkopf- Spanplattenschraube mit Fräsrippen, Innensechsrund, Gewinde patentiert, verzinkt und mit Wachs
- 🇪🇸 Tornillo para aglomerado, cabeza avellanada 6 lóbulos internos con estrías avellanadoras, con fresa y especial rosca patentada, cincado y encerado
- 🇷🇺 Зпатентованный оцинкованный шуруп по дереву из закаленной стали с плоской потайной головкой с шестигранным шлицем, со спиральной накаткой на стержне и специальным восковым покрытием

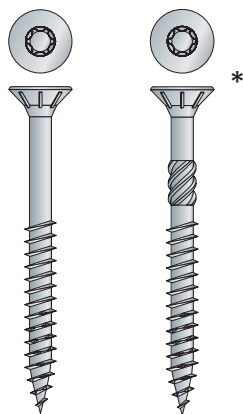

- * With reamer starting from 50 mm length (Ø 4 mm)
- 🇫🇷 * Avec alésoir à partir de la longueur 50 mm (Ø 4 mm)
- 🇩🇪 * Mit Reibahle von der Länge 50 mm (Ø 4 mm)
- 🇪🇸 * Con fresa a partir de la largueza 50 mm (Ø 4 mm)
- 🇷🇺 * С накаткой для размера 50 мм и выше (Ø 4 mm)



CE Certified according to the **EN 14592:2008+A1:2012**, for structural timber applications.
Nominal diameter and technical details in:
DoP n. P1210/13-630-1-TJ

Item code	Screw size Ø x L / L ₁ (mm)	Pcs. per box	Pcs. per carton
Ø 3 / T-10			
TJ 01 30 010	3 x 10	500	5.000
☑️ TJ 01 30 012	3 x 12	500	5.000
☑️ TJ 01 30 016	3 x 16	500	5.000
☑️ TJ 01 30 020	3 x 20	500	5.000
☑️ TJ 01 30 025	3 x 25 / 18	500	5.000
☑️ TJ 01 30 030	3 x 30 / 18	500	5.000
☑️ TJ 01 30 035	3 x 35 / 21	500	5.000
☑️ TJ 01 30 040	3 x 40 / 25	500	5.000
☑️ TJ 01 30 045	3 x 45 / 28	500	5.000
Ø 3,5 / T-15			
TJ 01 35 012	3,5 x 12	500	5.000
☑️ TJ 01 35 016	3,5 x 16	500	5.000
☑️ TJ 01 35 018	3,5 x 18	500	5.000
☑️ TJ 01 35 020	3,5 x 20	500	5.000
☑️ TJ 01 35 025	3,5 x 25 / 18	500	5.000
☑️ TJ 01 35 030	3,5 x 30 / 18	500	5.000
☑️ TJ 01 35 035	3,5 x 35 / 21	500	5.000
☑️ TJ 01 35 040	3,5 x 40 / 25	500	5.000
☑️ TJ 01 35 045	3,5 x 45 / 28	500	5.000
☑️ TJ 01 35 050	3,5 x 50 / 30	500	5.000
Ø 4 / T-20			
☑️ TJ 01 40 016	4 x 16	500	5.000
☑️ TJ 01 40 018	4 x 18	500	5.000
☑️ TJ 01 40 020	4 x 20	500	5.000
☑️ TJ 01 40 025	4 x 25 / 18	500	5.000
☑️ TJ 01 40 030	4 x 30 / 18	500	5.000
☑️ TJ 01 40 035	4 x 35 / 21	500	5.000
☑️ TJ 01 40 040	4 x 40 / 25	500	5.000
☑️ TJ 01 40 045	4 x 45 / 28	200	2.000
☑️ TJ 01 40 050	4 x 50 / 30	200	2.000
☑️ TJ 01 40 060	4 x 60 / 35	200	2.000
☑️ TJ 01 40 070	4 x 70 / 45	200	2.000
Ø 4,5 / T-20			
☑️ TJ 01 45 020	4,5 x 20	500	5.000
☑️ TJ 01 45 025	4,5 x 25 / 18	500	5.000
☑️ TJ 01 45 030	4,5 x 30 / 18	500	5.000
☑️ TJ 01 45 035	4,5 x 35 / 21	500	5.000
☑️ TJ 01 45 040	4,5 x 40 / 25	500	5.000
☑️ TJ 01 45 045	4,5 x 45 / 28	200	2.000
☑️ TJ 01 45 050	4,5 x 50 / 30	200	2.000
☑️ TJ 01 45 060	4,5 x 60 / 35	200	2.000
☑️ TJ 01 45 070	4,5 x 70 / 45	200	2.000
☑️ TJ 01 45 080	4,5 x 80 / 48	200	2.000

☑️ CE Certified / Certifié CE / CE Zulassung / Certificado CE / Сертификат CE >>>
🔥 Fire Reaction A1 / Réaction au feu A1 / Brandverhalten A1 / Reacción al fuego A1 / Реакция на огонь A1

TJ 01

Flat CSK head with ribs 6-lobe recess chipboard screw with reamer and special patented thread, zinc plated and waxed

- Vis à tête fraisée plate avec nervures pour panneaux de particules, empreinte six lobes X, avec filetage breveté, en acier cémenté, zinguée et cirée
- Senkkopf- Spanplattenschraube mit Fräsrillen, Innensechsrund, Gewinde patentiert, verzinkt und mit Wachs
- Tornillo para aglomerado, cabeza avellanada 6 lóbulos internos con estrías avellanadoras, con fresa y especial rosca patentada, cincado y encerado
- Запатентованный оцинкованный шуруп по дереву из закаленной стали с плоской потайной головкой с шестигранным шлицем, со спиральной накаткой на стержне и специальным восковым покрытием

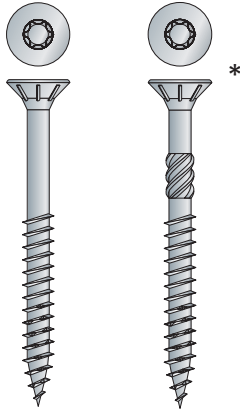

- * With reamer starting from 50 mm length (Ø 4 mm)
- * Avec alésoir à partir de la longueur 50 mm (Ø 4 mm)
- * Mit Reibahle von der Länge 50 mm (Ø 4 mm)
- * Con fresa a partir de la largueza 50 mm (Ø 4 mm)
- * С накаткой для размера 50 мм и выше (Ø 4 мм)



CE Certified according to the **EN 14592:2008+A1:2012**, for structural timber applications.
Nominal diameter and technical details in: DoP n. P1210/13-630-1-TJ

Item code	Screw size Ø x L / L ₁ (mm)	Pcs. per box	Pcs. per carton
Ø 5 / T-25			
CE TJ 01 50 020	5 x 20	500	5.000
CE TJ 01 50 025	5 x 25 / 18	500	5.000
CE TJ 01 50 030	5 x 30 / 18	500	5.000
CE TJ 01 50 035	5 x 35 / 21	500	5.000
CE TJ 01 50 040	5 x 40 / 25	200	2.000
CE TJ 01 50 045	5 x 45 / 28	200	2.000
CE TJ 01 50 050	5 x 50 / 30	200	2.000
CE TJ 01 50 060	5 x 60 / 35	200	2.000
CE TJ 01 50 070	5 x 70 / 45	200	2.000
CE TJ 01 50 080	5 x 80 / 48	200	2.000
CE TJ 01 50 090	5 x 90 / 48	100	1.000
CE TJ 01 50 100	5 x 100 / 60	100	1.000
CE TJ 01 50 120	5 x 120 / 70	100	1.000
CE TJ 01 50 140	5 x 140 / 70	100	1.000

Ø 6 / T-30			
CE TJ 01 60 030	6 x 30 / 18	200	2.000
CE TJ 01 60 040	6 x 40 / 25	200	2.000
CE TJ 01 60 050	6 x 50 / 30	200	2.000
CE TJ 01 60 060	6 x 60 / 35	200	2.000
CE TJ 01 60 070	6 x 70 / 45	200	2.000
CE TJ 01 60 080	6 x 80 / 48	100	1.000
CE TJ 01 60 100	6 x 100 / 60	100	1.000
CE TJ 01 60 120	6 x 120 / 70	100	1.000
CE TJ 01 60 140	6 x 140 / 70	100	1.000
CE TJ 01 60 160	6 x 160 / 70	100	1.000
CE TJ 01 60 180	6 x 180 / 70	100	1.000
CE TJ 01 60 200	6 x 200 / 70	100	1.000

CE Certified / Certifié CE / CE Zulassung / Certificado CE / Сертификат CE
Fire Reaction A1 / Réaction au feu A1 / Brandverhalten A1 / Reacción al fuego A1 / Реакция на огонь A1

Usage / Utilisation / Benutzung
Uso / Применение



Included in TADS - Tecfi Anchor Design Software for computer aided design of Anchorage.

Tecfi Anchor Design Software
www.tecfi.it/tads

DoP



One bit free per box



- one bit free per box (FM01)
- Un embout gratuit dans chaque boîte (FM01)
- Zu jeder Verpackung ein Bit kostenlos (FM01)
- Una punta de atornillar en cada caja (FM01)
- Один бесплатный бит в каждой упаковке (FM01)

Box / Boîte / Verpackung / Caja
Упаковка



TJ 02

🇬🇧 Flat CSK head with ribs 6-lobe recess chipboard screw with reamer and special patented thread, GOLD yellow ZP (CrVI free) and waxed

🇫🇷 Vis à tête fraisée plate avec nervures pour panneaux de particules, empreinte six lobes X, avec filetage breveté, en acier cémenté, zingué jaune or (sans CrVI) et cirée

🇩🇪 Senkkopf- Spanplattenschraube mit Fräsrippen, Innensechsrund, Gewinde patentiert, GOLD gelb ZP (CrVI frei) verzinkt und gewachst

🇪🇸 Tornillo para aglomerado, cabeza avellanada 6 lóbulos internos con estrías avellanadoras, con fresa y especial rosca patentada, bicromatado (efecto dorado – libre de CrVI) y encerado

🇷🇺 Запатентованный оцинкованный шуруп по дереву золотого цвета (GOLD без содержания Cr6) с плоской потайной головкой с шестигранным шлицем, со спиральной накаткой на стержне и специальным восковым покрытием

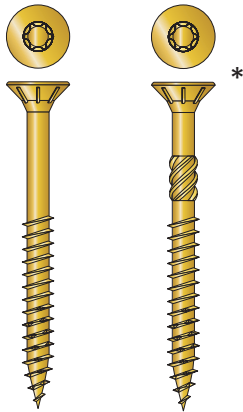

- 🇬🇧 * With reamer starting from 50 mm length (Ø 4 mm)
- 🇫🇷 * Avec alésoir à partir de la longueur 50 mm (Ø 4 mm)
- 🇩🇪 * Mit Reibahle von der Länge 50 mm (Ø 4 mm)
- 🇪🇸 * Con fresa a partir de la largueza 50 mm (Ø 4 mm)
- 🇷🇺 * С накаткой для размера 50 мм и выше (Ø 4 mm)



CE Certified according to the EN 14592:2008+A1:2012, for structural timber applications.
Nominal diameter and technical details in: DoP n. P1210/13-630-1-TJ

Item code	Screw size Ø x L / L ₁ (mm)	Pcs. per box	Pcs. per carton
Ø 3 / T-10			
TJ 02 30 010	3 x 10	500	5.000
CE TJ 02 30 012	3 x 12	500	5.000
IN CE TJ 02 30 016	3 x 16	500	5.000
IN CE TJ 02 30 020	3 x 20	500	5.000
IN CE TJ 02 30 025	3 x 25 / 18	500	5.000
IN CE TJ 02 30 030	3 x 30 / 18	500	5.000
IN CE TJ 02 30 035	3 x 35 / 21	500	5.000
CE TJ 02 30 040	3 x 40 / 25	500	5.000
CE TJ 02 30 045	3 x 45 / 28	500	5.000
Ø 3,5 / T-15			
TJ 02 35 012	3,5 x 12	500	5.000
IN CE TJ 02 35 016	3,5 x 16	500	5.000
CE TJ 02 35 018	3,5 x 18	500	5.000
IN CE TJ 02 35 020	3,5 x 20	500	5.000
IN CE TJ 02 35 025	3,5 x 25 / 18	500	5.000
IN CE TJ 02 35 030	3,5 x 30 / 18	500	5.000
IN CE TJ 02 35 035	3,5 x 35 / 21	500	5.000
IN CE TJ 02 35 040	3,5 x 40 / 25	500	5.000
CE TJ 02 35 045	3,5 x 45 / 28	500	5.000
IN CE TJ 02 35 050	3,5 x 50 / 30	500	5.000
CE TJ 02 35 060	3,5 x 60 / 35	200	2.000
CE TJ 02 35 070	3,5 x 70 / 45	200	2.000
Ø 4 / T-20			
IN CE TJ 02 40 016	4 x 16	500	5.000
CE TJ 02 40 018	4 x 18	500	5.000
IN CE TJ 02 40 020	4 x 20	500	5.000
IN CE TJ 02 40 025	4 x 25 / 18	500	5.000
IN CE TJ 02 40 030	4 x 30 / 18	500	5.000
IN CE TJ 02 40 035	4 x 35 / 21	500	5.000
IN CE TJ 02 40 040	4 x 40 / 25	500	5.000
IN CE TJ 02 40 045	4 x 45 / 28	200	2.000
IN CE TJ 02 40 050	4 x 50 / 30	200	2.000
IN CE TJ 02 40 060	4 x 60 / 35	200	2.000
CE TJ 02 40 070	4 x 70 / 45	200	2.000
Ø 4,5 / T-20			
CE TJ 02 45 020	4,5 x 20	500	5.000
CE TJ 02 45 025	4,5 x 25 / 18	500	5.000
IN CE TJ 02 45 030	4,5 x 30 / 18	500	5.000
IN CE TJ 02 45 035	4,5 x 35 / 21	500	5.000
IN CE TJ 02 45 040	4,5 x 40 / 25	500	5.000
IN CE TJ 02 45 045	4,5 x 45 / 28	200	2.000
IN CE TJ 02 45 050	4,5 x 50 / 30	200	2.000
IN CE TJ 02 45 060	4,5 x 60 / 35	200	2.000
IN CE TJ 02 45 070	4,5 x 70 / 45	200	2.000
IN CE TJ 02 45 080	4,5 x 80 / 48	200	2.000

CE CE Certified / Certifié CE / CE Zulassung / Certificado CE / Сертификат CE

🔥 Fire Reaction A1 / Réaction au feu A1 / Brandverhalten A1 / Reacción al fuego A1 / Реакция на огонь A1 >>>

TJ 02

🇬🇧 Flat CSK head with ribs 6-lobe recess chipboard screw with reamer and special patented thread, GOLD yellow ZP (CrVI free) and waxed

🇫🇷 Vis à tête fraisée plate avec nervures pour panneaux de particules, empreinte six lobes X, avec filetage breveté, en acier cémenté, zingué jaune or (sans CrVI) et cirée

🇩🇪 Senkkopf- Spanplattenschraube mit Fräsrippen, Innensechsrund, Gewinde patentiert, GOLD gelb ZP (CrVI frei) verzinkt und gewachst

🇪🇸 Tornillo para aglomerado, cabeza avellanada 6 lóbulos internos con estrías avellanadoras, con fresa y especial rosca patentada, bicromatado (efecto dorado – libre de CrVI) y encerado

🇷🇺 Запатентованный оцинкованный шуруп по дереву золотого цвета (GOLD без содержания Cr6) с плоской потайной головкой с шестигранным шлицем, со спиральной накаткой на стержне и специальным восковым покрытием

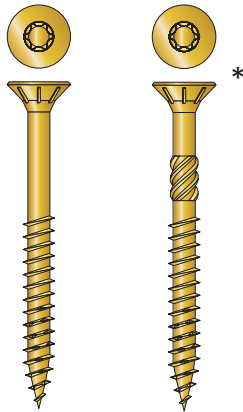

- 🇬🇧 * With reamer starting from 50 mm length (Ø 4 mm)
- 🇫🇷 * Avec alésoir à partir de la longueur 50 mm (Ø 4 mm)
- 🇩🇪 * Mit Reibahle von der Länge 50 mm (Ø 4 mm)
- 🇪🇸 * Con fresa a partir de la largueza 50 mm (Ø 4 mm)
- 🇷🇺 * С накаткой для размера 50 мм и выше (Ø 4 мм)



CE Certified according to the EN 14592:2008+A1:2012, for structural timber applications.
Nominal diameter and technical details in:
DoP n. P1210/13-630-1-TJ

Item code	Screw size Ø x L / L ₁ (mm)	Pcs. per box	Pcs. per carton
Ø 5 / T-25			
🇬🇧 🇪🇸 TJ 02 50 020	5 x 20	500	5.000
🇬🇧 🇪🇸 TJ 02 50 025	5 x 25	500	5.000
🇬🇧 🇪🇸 TJ 02 50 030	5 x 30 / 18	500	5.000
🇬🇧 🇪🇸 TJ 02 50 035	5 x 35 / 21	500	5.000
🇮🇹 🇬🇧 🇪🇸 TJ 02 50 040	5 x 40 / 25	200	2.000
🇬🇧 🇪🇸 TJ 02 50 045	5 x 45 / 28	200	2.000
🇮🇹 🇬🇧 🇪🇸 TJ 02 50 050	5 x 50 / 30	200	2.000
🇮🇹 🇬🇧 🇪🇸 TJ 02 50 060	5 x 60 / 35	200	2.000
🇮🇹 🇬🇧 🇪🇸 TJ 02 50 070	5 x 70 / 45	200	2.000
🇮🇹 🇬🇧 🇪🇸 TJ 02 50 080	5 x 80 / 48	200	2.000
🇮🇹 🇬🇧 🇪🇸 TJ 02 50 090	5 x 90 / 48	100	1.000
🇮🇹 🇬🇧 🇪🇸 TJ 02 50 100	5 x 100 / 60	100	1.000
🇬🇧 🇪🇸 TJ 02 50 110	5 x 110 / 70	100	1.000
🇮🇹 🇬🇧 🇪🇸 TJ 02 50 120	5 x 120 / 70	100	1.000
🇬🇧 🇪🇸 TJ 02 50 140	5 x 140 / 70	100	1.000
Ø 6 / T-30			
🇬🇧 🇪🇸 TJ 02 60 030	6 x 30 / 18	200	2.000
🇬🇧 🇪🇸 TJ 02 60 040	6 x 40 / 25	200	2.000
🇮🇹 🇬🇧 🇪🇸 TJ 02 60 050	6 x 50 / 30	200	2.000
🇮🇹 🇬🇧 🇪🇸 TJ 02 60 060	6 x 60 / 35	200	2.000
🇮🇹 🇬🇧 🇪🇸 TJ 02 60 070	6 x 70 / 45	200	2.000
🇮🇹 🇬🇧 🇪🇸 TJ 02 60 080	6 x 80 / 48	100	1.000
🇬🇧 🇪🇸 TJ 02 60 090	6 x 90 / 48	100	1.000
🇮🇹 🇬🇧 🇪🇸 TJ 02 60 100	6 x 100 / 60	100	1.000
🇬🇧 🇪🇸 TJ 02 60 110	6 x 110 / 70	100	1.000
🇮🇹 🇬🇧 🇪🇸 TJ 02 60 120	6 x 120 / 70	100	1.000
🇬🇧 🇪🇸 TJ 02 60 140	6 x 140 / 70	100	1.000
🇬🇧 🇪🇸 TJ 02 60 160	6 x 160 / 70	100	1.000
🇬🇧 🇪🇸 TJ 02 60 180	6 x 180 / 70	100	1.000
🇬🇧 🇪🇸 TJ 02 60 200	6 x 200 / 70	100	1.000

🇬🇧 🇪🇸 CE Certified / Certifié CE / CE Zulassung / Certificado CE / Сертификат CE
🔥 Fire Reaction A1 / Réaction au feu A1 / Brandverhalten A1 / Reacción al fuego A1 / Реакция на огонь A1

"Gold type - CrVI free" special coating



The new Tecfi "Gold type - CrVI free" coating, is a very appreciated deep yellow zinc plating, totally in compliance with REACH Regulation. For more info, please see technical introduction on page 15.

Usage / Utilisation / Benutzung
Uso / Применение



Tecfi Anchor Design Software
www.tecfi.it/tads

DoP



Box / Boîte / Verpackung / Caja
Упаковка



TJ 04

Flat CSK head with ribs 6-lobe recess chipboard screw with reamer and special patented thread, bronze plated and waxed

Vis à tête fraisée plate avec nervures pour panneaux de particules, empreinte six lobes X, avec filetage breveté, en acier cémenté, cémenté, bronzée et cirée

Senkkopf- Spanplattenschraube mit Fräsrippen, Innensechsrund, Gewinde patentiert, bronziert und mit Wachs

Tornillo para aglomerado, cabeza avellanada 6 lóbulos internos con estrías avellanadoras, con fresa y especial rosca patentada, bronceado y encerado

Запатентованный бронзовый шуруп по дереву из закаленной стали с плоской потайной головкой с шестигранным шлицем, со спиральной накаткой на стержне и специальным восковым покрытием

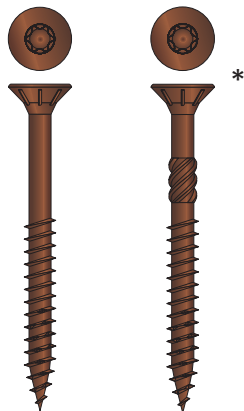

- * With reamer starting from 50 mm length (Ø 4 mm)
- * Avec alésair à partir de la longueur 50 mm (Ø 4 mm)
- * Mit Reibahle von der Länge 50 mm (Ø 4 mm)
- * Con fresa a partir de la largueza 50 mm (Ø 4 mm)
- * С накаткой для размера 50 мм и выше (Ø 4 mm)



Item code	Screw size Ø x L / L _i (mm)	Pcs. per box	Pcs. per carton
Ø 3 / T-10			
TJ 04 30 010	3 x 10	500	5.000
CE TJ 04 30 012	3 x 12	500	5.000
CE TJ 04 30 016	3 x 16	500	5.000
CE TJ 04 30 020	3 x 20	500	5.000
CE TJ 04 30 025	3 x 25 / 18	500	5.000
CE TJ 04 30 030	3 x 30 / 18	500	5.000
CE TJ 04 30 035	3 x 35 / 21	500	5.000
CE TJ 04 30 040	3 x 40 / 25	500	5.000
CE TJ 04 30 045	3 x 45 / 28	500	5.000
Ø 3,5 / T-15			
TJ 04 35 012	3,5 x 12	500	5.000
CE TJ 04 35 016	3,5 x 16	500	5.000
CE TJ 04 35 018	3,5 x 18	500	5.000
CE TJ 04 35 020	3,5 x 20	500	5.000
CE TJ 04 35 025	3,5 x 25 / 18	500	5.000
CE TJ 04 35 030	3,5 x 30 / 18	500	5.000
CE TJ 04 35 035	3,5 x 35 / 21	500	5.000
CE TJ 04 35 040	3,5 x 40 / 25	500	5.000
CE TJ 04 35 045	3,5 x 45 / 28	500	5.000
CE TJ 04 35 050	3,5 x 50 / 30	500	5.000
Ø 4 / T-20			
CE TJ 04 40 016	4 x 16	500	5.000
CE TJ 04 40 018	4 x 18	500	5.000
CE TJ 04 40 020	4 x 20	500	5.000
CE TJ 04 40 025	4 x 25 / 18	500	5.000
CE TJ 04 40 030	4 x 30 / 18	500	5.000
CE TJ 04 40 035	4 x 35 / 21	500	5.000
CE TJ 04 40 040	4 x 40 / 25	500	5.000
CE TJ 04 40 045	4 x 45 / 28	200	2.000
CE TJ 04 40 050	4 x 50 / 30	200	2.000
CE TJ 04 40 060	4 x 60 / 35	200	2.000
CE TJ 04 40 070	4 x 70 / 45	200	2.000
Ø 4,5 / T-20			
CE TJ 04 45 020	4,5 x 20	500	5.000
CE TJ 04 45 025	4,5 x 25 / 18	500	5.000
CE TJ 04 45 030	4,5 x 30 / 18	500	5.000
CE TJ 04 45 035	4,5 x 35 / 21	500	5.000
CE TJ 04 45 040	4,5 x 40 / 25	500	5.000
CE TJ 04 45 045	4,5 x 45 / 28	200	2.000
CE TJ 04 45 050	4,5 x 50 / 30	200	2.000
CE TJ 04 45 060	4,5 x 60 / 35	200	2.000
CE TJ 04 45 070	4,5 x 70 / 45	200	2.000
CE TJ 04 45 080	4,5 x 80 / 48	200	2.000

CE CE Certified / Certifié CE / CE Zulassung / Certificado CE / Сертификат CE >>>
 Fire Reaction A1 / Réaction au feu A1 / Brandverhalten A1 / Reacció al fuego A1 / Реакция на огонь A1

TJ 04

Flat CSK head with ribs 6-lobe recess chipboard screw with reamer and special patented thread, bronze plated and waxed

Vis à tête fraisée plate avec nervures pour panneaux de particules, empreinte six lobes X, avec filetage breveté, en acier cémenté, cémenté, bronzée et cirée

Senkkopf- Spanplattenschraube mit Fräsrippen, Innensechsrund, Gewinde patentiert, bronziert und mit Wachs

Tornillo para aglomerado, cabeza avellanada 6 lóbulos internos con estrías avellanadoras, con fresa y especial rosca patentada, bronceado y encerado

Запатентованный бронзовый шуруп по дереву из закаленной стали с плоской потайной головкой с шестигранным шлицем, со спиральной накаткой на стержне и специальным восковым покрытием

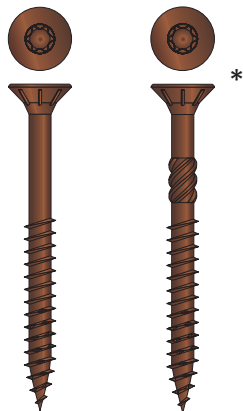

- * With reamer starting from 50 mm length (Ø 4 mm)
- * Avec alésair à partir de la longueur 50 mm (Ø 4 mm)
- * Mit Reibahle von der Länge 50 mm (Ø 4 mm)
- * Con fresa a partir de la largueza 50 mm (Ø 4 mm)
- * С накаткой для размера 50 мм и выше (Ø 4 мм)



CE Certified according to the EN 14592:2008+A1:2012, for structural timber applications.
Nominal diameter and technical details in: DoP n. P1210/13-630-1-TJ

Item code	Screw size Ø x L / L _i (mm)	Pcs. per box	Pcs. per carton
Ø 5 / T-25			
CE TJ 04 50 020	5 x 20	500	5.000
CE TJ 04 50 025	5 x 25	500	5.000
CE TJ 04 50 030	5 x 30 / 18	500	5.000
CE TJ 04 50 035	5 x 35 / 21	500	5.000
CE TJ 04 50 040	5 x 40 / 25	200	2.000
CE TJ 04 50 045	5 x 45 / 28	200	2.000
CE TJ 04 50 050	5 x 50 / 30	200	2.000
CE TJ 04 50 060	5 x 60 / 35	200	2.000
CE TJ 04 50 070	5 x 70 / 45	200	2.000
CE TJ 04 50 080	5 x 80 / 48	200	2.000
CE TJ 04 50 090	5 x 90 / 48	100	1.000
CE TJ 04 50 100	5 x 100 / 60	100	1.000
CE TJ 04 50 110	5 x 110 / 70	100	1.000
CE TJ 04 50 120	5 x 120 / 70	100	1.000
CE TJ 04 50 140	5 x 140 / 70	100	1.000
Ø 6 / T-30			
CE TJ 04 60 030	6 x 30 / 18	200	2.000
CE TJ 04 60 040	6 x 40 / 25	200	2.000
CE TJ 04 60 050	6 x 50 / 30	200	2.000
CE TJ 04 60 060	6 x 60 / 35	200	2.000
CE TJ 04 60 070	6 x 70 / 45	200	2.000
CE TJ 04 60 080	6 x 80 / 48	100	1.000
CE TJ 04 60 090	6 x 90 / 48	100	1.000
CE TJ 04 60 100	6 x 100 / 60	100	1.000
CE TJ 04 60 110	6 x 110 / 70	100	1.000
CE TJ 04 60 120	6 x 120 / 70	100	1.000
CE TJ 04 60 140	6 x 140 / 70	100	1.000
CE TJ 04 60 160	6 x 160 / 70	100	1.000
CE TJ 04 60 180	6 x 180 / 70	100	1.000
CE TJ 04 60 200	6 x 200 / 70	100	1.000

CE Certified / Certifié CE / CE Zulassung / Certificado CE / Сертификат CE
Fire Reaction A1 / Réaction au feu A1 / Brandverhalten A1 / Reacción al fuego A1 / Реакция на огонь A1

Usage / Utilisation / Benutzung
Uso / Применение



Included in TADS - Tecfi Anchor Design Software for computer aided design of Anchorage.

Tecfi Anchor Design Software
www.tecfi.it/tads

DoP



One bit free per box



- one bit free per box (FM01)
- Un embout gratuit dans chaque boîte (FM01)
- Zu jeder Verpackung ein Bit kostenlos (FM01)
- Una punta de atornillar en cada caja (FM01)
- Один бесплатный бит в каждой упаковке (FM01)

Box / Boîte / Verpackung / Caja
Упаковка



🇬🇧 (AISI 304) A2 stainless steel Flat CSK head cross type Z recess chipboard screw, passivated and waxed

- 🇫🇷 Vis acier inox A2 (AISI 304) à tête fraisée plate avec nervures pour panneaux de particules, empreinte cruciforme Type Z, avec filetage breveté
- 🇩🇪 Edelstahl A2 (AISI 304) Senkkopf- Spanplattenschraube mit Fräsrippen, Kreuzschlitz Z, Gewinde patentiert, mit Wachs
- 🇪🇸 Tornillo para aglomerado, cabeza avellanada cruz tipo Z, de acero inoxidable A2 (AISI 304), pasivado y encerado
- 🇷🇺 Шуруп по дереву из нержавеющей стали A2 (AISI 304) с плоской потайной головкой с насечками с крестообразным шлицем типа Z, со специальным восковым покрытием

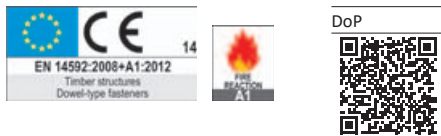
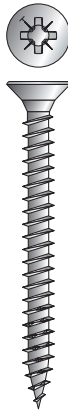

CE Certified according to the **EN 14592:2008+A1:2012**, for structural timber applications. Nominal diameter and technical details in: DoP n. P1210/13-630-1-FT

Usage / Utilisation / Benutzung
Usò / Применение

Box / Boîte / Verpackung /
Caja / Упаковка







Tecfi Anchor Design Software
www.tecfi.it/tads





Item code	Screw size Ø x L / L ₁ (mm)	Pcs. per box	Pcs. per carton
Ø 3 / Pz 1			
CE FT 01 30 012	3 x 12	500	5.000
CE FT 01 30 016	3 x 16	500	5.000
CE FT 01 30 018	3 x 18	500	5.000
IN CE FT 01 30 020	3 x 20	500	5.000
CE FT 01 30 025	3 x 25	500	5.000
IN CE FT 01 30 030	3 x 30	500	5.000
CE FT 01 30 035	3 x 35	500	5.000
CE FT 01 30 040	3 x 40	500	5.000
CE FT 01 30 045	3 x 45	500	5.000
Ø 3,5 / Pz 2			
FT 01 35 012	3,5 x 12	500	5.000
CE FT 01 35 016	3,5 x 16	500	5.000
CE FT 01 35 018	3,5 x 18	500	5.000
CE FT 01 35 020	3,5 x 20	500	5.000
CE FT 01 35 025	3,5 x 25	500	5.000
CE FT 01 35 030	3,5 x 30	500	5.000
CE FT 01 35 035	3,5 x 35	500	5.000
IN CE FT 01 35 040	3,5 x 40	500	5.000
CE FT 01 35 045	3,5 x 45	500	5.000
IN CE FT 01 35 050	3,5 x 50	500	5.000
Ø 4 / Pz 2			
CE FT 01 40 016	4 x 16	500	5.000
CE FT 01 40 018	4 x 18	500	5.000
CE FT 01 40 020	4 x 20	500	5.000
CE FT 01 40 025	4 x 25	500	5.000
CE FT 01 40 030	4 x 30	500	5.000
CE FT 01 40 035	4 x 35	500	5.000
IN CE FT 01 40 040	4 x 40	500	5.000
CE FT 01 40 045	4 x 45	200	2.000
IN CE FT 01 40 050	4 x 50	200	2.000
IN CE FT 01 40 060	4 x 60	200	2.000
CE FT 01 40 070	4 x 70	200	2.000
Ø 4,5 / Pz 2			
CE FT 01 45 020	4,5 x 20	500	5.000
CE FT 01 45 025	4,5 x 25	500	5.000
CE FT 01 45 030	4,5 x 30	500	5.000
CE FT 01 45 035	4,5 x 35	500	5.000
IN CE FT 01 45 040	4,5 x 40	500	5.000
CE FT 01 45 045	4,5 x 45	200	2.000
IN CE FT 01 45 050	4,5 x 50	200	2.000
IN CE FT 01 45 060	4,5 x 60	200	2.000
CE FT 01 45 070	4,5 x 70	200	2.000
CE FT 01 45 080	4,5 x 80 / 60	200	2.000
Ø 5 / Pz 2			
CE FT 01 50 020	5 x 20	500	5.000
CE FT 01 50 025	5 x 25	500	5.000
CE FT 01 50 030	5 x 30	500	5.000
CE FT 01 50 035	5 x 35	500	5.000
IN CE FT 01 50 040	5 x 40	200	2.000
CE FT 01 50 045	5 x 45	200	2.000
IN CE FT 01 50 050	5 x 50	200	2.000
IN CE FT 01 50 060	5 x 60	200	2.000
IN CE FT 01 50 070	5 x 70	200	2.000
CE FT 01 50 080	5 x 80 / 60	200	2.000
CE FT 01 50 100	5 x 100 / 60	100	1.000
Ø 6 / Pz 3			
CE FT 01 60 030	6 x 30	200	2.000
CE FT 01 60 040	6 x 40	200	2.000
IN CE FT 01 60 050	6 x 50	200	2.000
IN CE FT 01 60 060	6 x 60	200	2.000
IN CE FT 01 60 070	6 x 70	200	2.000
CE FT 01 60 080	6 x 80 / 60	200	2.000
CE FT 01 60 100	6 x 100 / 60	100	1.000

CE Certified / Certifié CE / CE Zulassung / Certificado CE / Сертификат CE
Fire Reaction A1 / Réaction au feu A1 / Brandverhalten A1 / Reacción al fuego A1 / Реакция на огонь A1

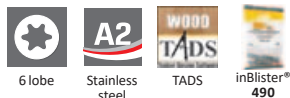
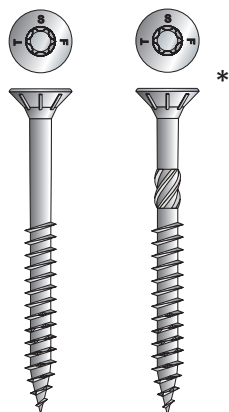
(AISI 304) A2 stainless steel Flat CSK head 6-lobe recess chipboard screw, passivated and waxed

-  Vis acier inox A2 (AISI 304) à tête fraisée plate avec nervures pour panneaux de particules, empreinte à six lobes X, avec filetage breveté, en acier cémenté, cirée
-  Edelstahl A2 (AISI 304) Senkkopf- Spanplattenschraube mit Fräsrippen, Innensechsrund, Gewinde patentiert, mit Wachs
-  Tornillo para aglomerado, cabeza avellanada 6 lóbulos internos, con fresa y especial rosca patentada, de acero inoxidable A2 (AISI 304), pasivado y encerado
-  Запатентованный шуруп по дереву из нержавеющей стали A2 (AISI 304) с плоской потайной головкой с шестигранным шлицем, со спиральной накаткой на стержне и специальным восковым покрытием



-  * With reamer starting from 50 mm length
-  * Avec alésoir à partir de la longueur 50 mm
-  * Mit Reibahle von der Länge 50 mm
-  * Con fresa a partir de la largueza 50 mm
-  * С накаткой для размера 50 мм и выше



CE Certified according to the EN 14592:2008+A1:2012, for structural timber applications. Nominal diameter and technical details in:

DoP n. P1210/13-630-1-FJ

Usage / Utilisation / Benutzung
Uso / Применение































































































































Box / Boîte / Verpackung /
Caja / Упаковка



Included in TADS - Tecfi Anchor Design Software for computer aided design of Anchorage.



Tecfi Anchor Design Software
www.tecfi.it/tads

Item code	Screw size Ø x L / L ₁ (mm)	Pcs. per box	Pcs. per carton
Ø 3 / T-10			
  FJ 01 30 012	3 x 12	500	5.000
  FJ 01 30 016	3 x 16	500	5.000
  FJ 01 30 018	3 x 18	500	5.000
   FJ 01 30 020	3 x 20	500	5.000
  FJ 01 30 025	3 x 25 / 18	500	5.000
   FJ 01 30 030	3 x 30 / 18	500	5.000
  FJ 01 30 035	3 x 35 / 21	500	5.000
  FJ 01 30 040	3 x 40 / 25	500	5.000
  FJ 01 30 045	3 x 45 / 28	500	5.000
Ø 3,5 / T-15			
  FJ 01 35 012	3,5 x 12	500	5.000
  FJ 01 35 016	3,5 x 16	500	5.000
  FJ 01 35 018	3,5 x 18	500	5.000
  FJ 01 35 020	3,5 x 20	500	5.000
  FJ 01 35 025	3,5 x 25 / 18	500	5.000
  FJ 01 35 030	3,5 x 30 / 18	500	5.000
  FJ 01 35 035	3,5 x 35 / 21	500	5.000
   FJ 01 35 040	3,5 x 40 / 25	500	5.000
  FJ 01 35 045	3,5 x 45 / 28	500	5.000
   FJ 01 35 050	3,5 x 50 / 30	500	5.000
Ø 4 / T-20			
  FJ 01 40 016	4 x 16	500	5.000
  FJ 01 40 020	4 x 20	500	5.000
  FJ 01 40 025	4 x 25 / 18	500	5.000
  FJ 01 40 030	4 x 30 / 18	500	5.000
  FJ 01 40 035	4 x 35 / 21	500	5.000
   FJ 01 40 040	4 x 40 / 25	500	5.000
  FJ 01 40 045	4 x 45 / 28	200	2.000
   FJ 01 40 050	4 x 50 / 30	200	2.000
   FJ 01 40 060	4 x 60 / 35	200	2.000
Ø 4,5 / T-20			
  FJ 01 45 020	4,5 x 20	500	5.000
  FJ 01 45 025	4,5 x 25 / 18	500	5.000
  FJ 01 45 030	4,5 x 30 / 18	500	5.000
  FJ 01 45 035	4,5 x 35 / 21	500	5.000
   FJ 01 45 040	4,5 x 40 / 25	500	5.000
  FJ 01 45 045	4,5 x 45 / 28	200	2.000
   FJ 01 45 050	4,5 x 50 / 30	200	2.000
   FJ 01 45 060	4,5 x 60 / 35	200	2.000
  FJ 01 45 070	4,5 x 70 / 45	200	2.000
Ø 5 / T-25			
  FJ 01 50 020	5 x 20	500	5.000
  FJ 01 50 025	5 x 25 / 18	500	5.000
  FJ 01 50 030	5 x 30 / 18	500	5.000
  FJ 01 50 035	5 x 35 / 21	500	5.000
   FJ 01 50 040	5 x 40 / 25	200	2.000
  FJ 01 50 045	5 x 45 / 28	200	2.000
   FJ 01 50 050	5 x 50 / 30	200	2.000
   FJ 01 50 060	5 x 60 / 35	200	2.000
   FJ 01 50 070	5 x 70 / 45	200	2.000
  FJ 01 50 080	5 x 80 / 48	200	2.000
  FJ 01 50 100	5 x 100 / 60	100	1.000
Ø 6 / T-30			
  FJ 01 60 030	6 x 30 / 18	200	2.000
  FJ 01 60 040	6 x 40 / 25	200	2.000
   FJ 01 60 050	6 x 50 / 30	200	2.000
   FJ 01 60 060	6 x 60 / 35	200	2.000
   FJ 01 60 070	6 x 70 / 45	200	2.000
  FJ 01 60 080	6 x 80 / 48	200	2.000
 FJ 01 60 100	6 x 100 / 60	100	1.000

 **CE Certified** / Certifié CE / CE Zulassung / Certificado CE / Сертификат CE

 **Fire Reaction A1** / Réaction au feu A1 / Brandverhalten A1 / Reacción al fuego A1 / Реакция на огонь

XP

Reduced flat CSK head with ribs 6-lobe recess chipboard screw with reduced self drilling point and with reamer

- Vis tête fraisée plate réduite pour panneaux de particules avec aisoir, empreinte 6 lobes, pointe auto-perceuse réduite, en acier cémenté, zingué blanc et ciré
- Spanplatten Schraube mit Fräsrippen und reduziertem CSK Senkkopf, Innensechsrund, mit reduziertem Selbstbohrpunkt, passiviert, mit Wachs
- Tornillo para aglomerado con broca reducida y fresa, cabeza avellanada reducida con 6 lóbulos internos y estrías avellanadoras, acero cementado
- Винт с уменьшенной потайной головкой для ДСП с расширителем, с шестигранным шлицем, уменьшенный наконечник для самосверления, из закаленной стали, воском покрытым

XP 01 zinc plated and waxed / zinguée / verzinkt / cincado y encerado / Оцинкованный

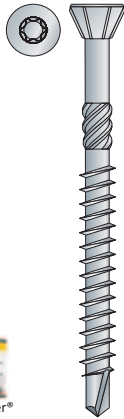

Item code	Screw size Ø x L / L ₁ (mm)	Fixture Thickness (t _{fix})		Pcs. per box	Pcs. per carton
		A (mm)	B (mm)		
Ø 3,2 / T-10					
* CE XP 01 32 020	3,2 x 20 / 16	4	3	500	5.000
CE XP 01 32 025	3,2 x 25 / 16	9	6	500	5.000
CE XP 01 32 030	3,2 x 30 / 16	14	10	500	5.000
CE XP 01 32 035	3,2 x 35 / 16	19	13	500	5.000
CE XP 01 32 040	3,2 x 40 / 26	14	10	500	5.000
CE XP 01 32 045	3,2 x 45 / 26	19	13	500	5.000
CE XP 01 32 050	3,2 x 50 / 26	24	17	500	5.000
Ø 4 / T-15					
CE XP 01 40 040	4 x 40 / 30	10	7	500	5.000
CE XP 01 40 050	4 x 50 / 30	20	14	200	2.000
CE XP 01 40 060	4 x 60 / 36	24	17	200	2.000
CE XP 01 40 070	4 x 70 / 36	34	24	200	2.000
CE XP 01 40 080	4 x 80 / 46	44	31	200	2.000



* Without reamer / Mesures sans Alésoir / Maßnahmen ohne Reibahle / Medidas sin Escariador / Размеры без накатки
 CE Certified / Certifié CE / CE Zulassung / Certificado CE / Сертификат CE
 Fire Reaction A1 / Réaction au feu A1 / Brandverhalten A1 / Reacción al fuego A1 / Реакция на огонь A1

Box / Boîte / Verpackung / Caja / Упаковка



XP 02 GOLD yellow ZP (CrVI free) and waxed / zinguée jaune or (sans CrVI) / GOLD gelb ZP (CrVI frei) verzinkt und gewachst / bicromatado (efecto dorado – libre de CrVI) y encerado / золотого цвета (GOLD без содержания Cr6)

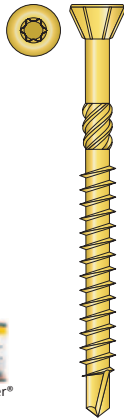

Item code	Screw size Ø x L / L ₁ (mm)	Fixture Thickness (t _{fix})		Pcs. per box	Pcs. per carton
		A (mm)	B (mm)		
Ø 3,2 / T-10					
* CE XP 02 32 020	3,2 x 20 / 16	4	3	500	5.000
CE XP 02 32 025	3,2 x 25 / 16	9	6	500	5.000
CE XP 02 32 030	3,2 x 30 / 16	14	10	500	5.000
CE XP 02 32 035	3,2 x 35 / 16	19	13	500	5.000
CE XP 02 32 040	3,2 x 40 / 26	14	10	500	5.000
CE XP 02 32 045	3,2 x 45 / 26	19	13	500	5.000
CE XP 02 32 050	3,2 x 50 / 26	24	17	500	5.000
Ø 4 / T-15					
CE XP 02 40 040	4 x 40 / 30	10	7	500	5.000
CE XP 02 40 050	4 x 50 / 30	20	14	200	2.000
CE XP 02 40 060	4 x 60 / 36	24	17	200	2.000
CE XP 02 40 070	4 x 70 / 36	34	24	200	2.000
CE XP 02 40 080	4 x 80 / 46	44	31	200	2.000

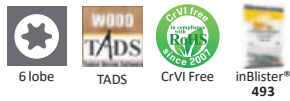

* Without reamer / Mesures sans Alésoir / Maßnahmen ohne Reibahle / Medidas sin Escariador / Размеры без накатки
 CE Certified / Certifié CE / CE Zulassung / Certificado CE / Сертификат CE
 Fire Reaction A1 / Réaction au feu A1 / Brandverhalten A1 / Reacción al fuego A1 / Реакция на огонь A1

“Gold type - CrVI free” special coating
 The new Tecfi “Gold type - CrVI free” coating, is a very appreciated deep yellow zinc plating, totally in compliance with REACH Regulation. For more info, please see technical introduction on page 15.

Box / Boîte / Verpackung / Caja / Упаковка



XP

Reduced flat CSK head with ribs 6-lobe recess chipboard screw with reduced self drilling point and with reamer

- Vis tête fraisée plate réduite pour panneaux de particules avec aisoir, empreinte 6 lobes, pointe auto-perceuse réduite, en acier cementé, zingué blanc et ciré
- Spanplatten Schraube mit Fräsrippen und reduziertem CSK Senkkopf, Innensechsrund, mit reduziertem Selbstbohrpunkt, passiviert, mit Wachs
- Tornillo para aglomerado con broca reducida y fresa, cabeza avellanada reducida con 6 lóbulos internos y estrías avellanadoras, acero cementado
- Винт с уменьшенной потайной головкой для ДСП с расширителем, с шестигранным шлицем, уменьшенный наконечник для самосверления, из закаленной стали, воском покрыт

XP 04 bronze plated and waxed / bronzé et ciré / bronziert / bronceado y encerado / бронзовый

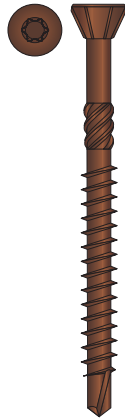

Item code	Screw size Ø x L / L ₁ (mm)	Fixture Thickness (t _{fix})		Pcs. per box	Pcs. per carton
		A (mm)	B (mm)		
Ø 3,2 / T-10					
* CE XP 04 32 020	3,2 x 20 / 16	4	3	500	5.000
CE XP 04 32 025	3,2 x 25 / 16	9	6	500	5.000
CE XP 04 32 030	3,2 x 30 / 16	14	10	500	5.000
CE XP 04 32 035	3,2 x 35 / 16	19	13	500	5.000
CE XP 04 32 040	3,2 x 40 / 26	14	10	500	5.000
CE XP 04 32 045	3,2 x 45 / 26	19	13	500	5.000
CE XP 04 32 050	3,2 x 50 / 26	24	17	500	5.000
Ø 4 / T-15					
CE XP 04 40 040	4 x 40 / 30	10	7	500	5.000
CE XP 04 40 050	4 x 50 / 30	20	14	200	2.000
CE XP 04 40 060	4 x 60 / 36	24	17	200	2.000
CE XP 04 40 070	4 x 70 / 36	34	24	200	2.000
CE XP 04 40 080	4 x 80 / 46	44	31	200	2.000

* Without reamer / Mesures sans Alésoir / Maßnahmen ohne Reibahle / Medidas sin Escariador / Размеры без накатки

CE Certified / Certifié CE / CE Zulassung / Certificado CE / Сертификат CE

Fire Reaction A1 / Réaction au feu A1 / Brandverhalten A1 / Reacción al fuego A1 / Реакция на огонь A1



DoP



One bit free per box



one bit free per box

- Un embout gratuit dans chaque boîte
- Zu jeder Verpackung ein Bit kostenlos
- Una punta de atornillar en cada caja
- Один бесплатный бит в каждой упаковке

Usage / Utilisation / Benutzung / Uso / Применение

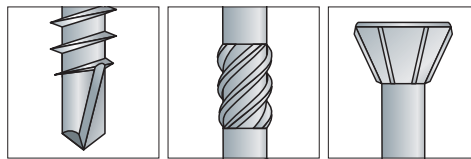

Thanks to the reduced self drilling point, to the reamer and to the special shape of the reduced head, this screw is particularly suitable for very hard and thin wood (avoiding edge splitting), e.g. glazing beads, grooved boards for wooden flooring, decking, etc.

Installation sequence / Instructions de mise en oeuvre / Setzanweisung / Secuencia de instalación / Порядок монтажа

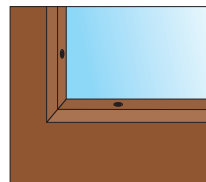
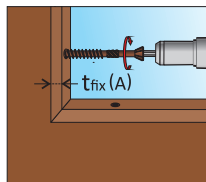
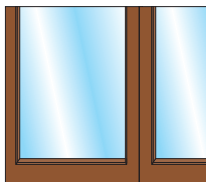

tfix (A): thickness of the fixture with orthogonal driving.

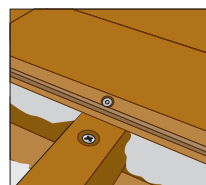
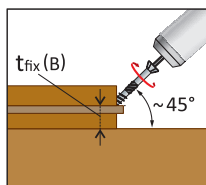
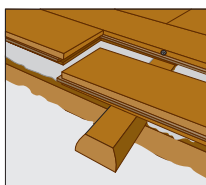

tfix (B): thickness of the fixture calculated with 45° driving.

Box / Boîte / Verpackung / Caja / Упаковка



TM 02

🇬🇧 Pan head cross type Z recess chipboard screw with special patented thread, GOLD yellow ZP (CrVI free) and waxed

🇫🇷 Vis tête cylindrique pour panneaux de particules, empreinte cruciforme type Z, filetage breveté, zingué jaune or (sans CrVI) et cirée

🇩🇪 Spanplatte- Halbrundkopfschraube, Kreuzschlitz Z, Gewinde patentiert, GOLD gelb ZP (CrVI frei) verzinkt und gewachst

🇪🇸 Tornillo para aglomerado, cabeza cilíndrica cruz tipo Z, especial rosca patentada, bicromatado (efecto dorado – libre de CrVI) y encerado

🇷🇺 Запатентованный оцинкованный шуруп по дереву золотого цвета (GOLD без содержания Cr6) с цилиндрической скругленной головкой с крестообразным шлицем типа Z, со специальным восковым покрытием

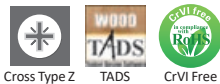
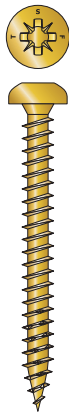

CE Certified according to the EN 14592:2008+A1:2012, for structural timber applications. Nominal diameter and technical details in: DoP n. P1210/13-630-1-TM

DoP



"Gold type - CrVI free" special coating



The new Tecfi "Gold type - CrVI free" coating, is a very appreciated deep yellow zinc plating, totally in compliance with REACH Regulation. For more info, please see technical introduction on page 15.

Box / Boîte / Verpackung
Caja / Упаковка

Usage / Utilisation / Benutzung
Uso / Применение



Included in TADS - Tecfi Anchor Design Software for computer aided design of Anchorage.

Tecfi Anchor Design Software
www.tecfi.it/tads

Item code	Screw size Ø x L / L ₁ (mm)	Pcs. per box	Pcs. per carton
Ø 3 / Pz 1			
TM 02 30 010	3 x 10	500	5.000
CE TM 02 30 012	3 x 12	500	5.000
CE TM 02 30 016	3 x 16	500	5.000
CE TM 02 30 018	3 x 18	500	5.000
CE TM 02 30 020	3 x 20	500	5.000
CE TM 02 30 025	3 x 25	500	5.000
CE TM 02 30 030	3 x 30	500	5.000
Ø 3,5 / Pz 2			
TM 02 35 012	3,5 x 12	500	5.000
CE TM 02 35 016	3,5 x 16	500	5.000
CE TM 02 35 018	3,5 x 18	500	5.000
CE TM 02 35 020	3,5 x 20	500	5.000
CE TM 02 35 025	3,5 x 25	500	5.000
CE TM 02 35 030	3,5 x 30	500	5.000
CE TM 02 35 035	3,5 x 35	500	5.000
CE TM 02 35 040	3,5 x 40	500	5.000
Ø 4 / Pz 2			
CE TM 02 40 016	4 x 16	500	5.000
CE TM 02 40 020	4 x 20	500	5.000
CE TM 02 40 025	4 x 25	500	5.000
CE TM 02 40 030	4 x 30	500	5.000
CE TM 02 40 035	4 x 35	500	5.000
CE TM 02 40 040	4 x 40	500	5.000
CE TM 02 40 045	4 x 45	200	2.000
CE TM 02 40 050	4 x 50	200	2.000
CE TM 02 40 060	4 x 60	200	2.000
Ø 4,5 / Pz 2			
CE TM 02 45 020	4,5 x 20	500	5.000
CE TM 02 45 025	4,5 x 25	500	5.000
CE TM 02 45 030	4,5 x 30	500	5.000
CE TM 02 45 035	4,5 x 35	500	5.000
CE TM 02 45 040	4,5 x 40	500	5.000
CE TM 02 45 045	4,5 x 45	200	2.000
CE TM 02 45 050	4,5 x 50	200	2.000
CE TM 02 45 060	4,5 x 60	200	2.000
Ø 5 / Pz 2			
CE TM 02 50 020	5 x 20	500	5.000
CE TM 02 50 025	5 x 25	500	5.000
CE TM 02 50 030	5 x 30	500	5.000
CE TM 02 50 035	5 x 35	500	5.000
CE TM 02 50 040	5 x 40	200	2.000
CE TM 02 50 045	5 x 45	200	2.000
CE TM 02 50 050	5 x 50	200	2.000
CE TM 02 50 060	5 x 60	200	2.000
CE TM 02 50 070	5 x 70 / 60	200	2.000
CE TM 02 50 080	5 x 80 / 60	200	2.000
CE TM 02 50 090	5 x 90 / 70	100	1.000
Ø 6 / Pz 3			
CE TM 02 60 040	6 x 40	200	2.000
CE TM 02 60 050	6 x 50	200	2.000
CE TM 02 60 060	6 x 60	100	1.000
CE TM 02 60 080	6 x 80 / 60	100	1.000
CE TM 02 60 100	6 x 100 / 70	100	1.000

CE CE Certified / Certifié CE / CE Zulassung / Certificado CE / Сертификат CE

🔥 Fire Reaction A1 / Réaction au feu A1 / Brandverhalten A1 / Reacción al fuego A1 / Реакция на огонь A1

TM 05

UK Pan head cross type Z recess chipboard screw with special patented thread, black zinc plated and waxed

FR Vis tête cylindrique pour panneaux de particules, empreinte cruciforme type Z, filetage breveté, zinguée noire et cirée

DE Spanplatte - Halbrundkopfschraube, Kreuzschlitz Z, Gewinde patentiert, schwarz verzinkt und mit Wachs

ES Tornillo para aglomerado, cabeza cilíndrica cruz tipo Z, especial rosca patentada, cincado negro y encerado

RU Запатентованный оцинкованный шуруп по дереву черного цвета с цилиндрической скругленной головкой с крестообразным шлицем типа Z из закаленной стали со специальным восковым покрытием

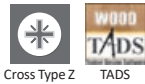
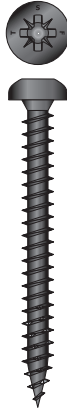

CE Certified according to the EN 14592:2008+A1:2012, for structural timber applications. Nominal diameter and technical details in: DoP n. P1210/13-630-1-TM

DoP



Box / Boîte / Verpackung
Caja / Упаковка

Usage / Utilisation / Benutzung
Uso / Применение



Included in TADS - Tecfi Anchor Design Software for computer aided design of Anchorage.

Tecfi Anchor Design Software
www.tecfi.it/tads

Item code	Screw size Ø x L / L ₁ (mm)	Pcs. per box	Pcs. per carton
Ø 3 / Pz 1			
TM 05 30 010	3 x 10	500	5.000
CE TM 05 30 012	3 x 12	500	5.000
CE TM 05 30 016	3 x 16	500	5.000
CE TM 05 30 018	3 x 18	500	5.000
CE TM 05 30 020	3 x 20	500	5.000
CE TM 05 30 025	3 x 25	500	5.000
CE TM 05 30 030	3 x 30	500	5.000
Ø 3,5 / Pz 2			
TM 05 35 012	3,5 x 12	500	5.000
CE TM 05 35 016	3,5 x 16	500	5.000
CE TM 05 35 018	3,5 x 18	500	5.000
CE TM 05 35 020	3,5 x 20	500	5.000
CE TM 05 35 025	3,5 x 25	500	5.000
CE TM 05 35 030	3,5 x 30	500	5.000
CE TM 05 35 035	3,5 x 35	500	5.000
CE TM 05 35 040	3,5 x 40	500	5.000
Ø 4 / Pz 2			
CE TM 05 40 016	4 x 16	500	5.000
CE TM 05 40 020	4 x 20	500	5.000
CE TM 05 40 025	4 x 25	500	5.000
CE TM 05 40 030	4 x 30	500	5.000
CE TM 05 40 035	4 x 35	500	5.000
CE TM 05 40 040	4 x 40	500	5.000
CE TM 05 40 045	4 x 45	200	2.000
CE TM 05 40 050	4 x 50	200	2.000
CE TM 05 40 060	4 x 60	200	2.000
Ø 4,5 / Pz 2			
CE TM 05 45 020	4,5 x 20	500	5.000
CE TM 05 45 025	4,5 x 25	500	5.000
CE TM 05 45 030	4,5 x 30	500	5.000
CE TM 05 45 035	4,5 x 35	500	5.000
CE TM 05 45 040	4,5 x 40	500	5.000
CE TM 05 45 045	4,5 x 45	200	2.000
CE TM 05 45 050	4,5 x 50	200	2.000
CE TM 05 45 060	4,5 x 60	200	2.000
Ø 5 / Pz 2			
CE TM 05 50 020	5 x 20	500	5.000
CE TM 05 50 025	5 x 25	500	5.000
CE TM 05 50 030	5 x 30	500	5.000
CE TM 05 50 035	5 x 35	500	5.000
CE TM 05 50 040	5 x 40	200	2.000
CE TM 05 50 045	5 x 45	200	2.000
CE TM 05 50 050	5 x 50	200	2.000
CE TM 05 50 060	5 x 60	200	2.000
CE TM 05 50 070	5 x 70 / 60	200	2.000
CE TM 05 50 080	5 x 80 / 60	200	2.000
CE TM 05 50 090	5 x 90 / 70	100	1.000
Ø 6 / Pz 3			
CE TM 05 60 040	6 x 40	200	2.000
CE TM 05 60 050	6 x 50	200	2.000
CE TM 05 60 060	6 x 60	200	2.000
CE TM 05 60 080	6 x 80 / 60	200	2.000
CE TM 05 60 100	6 x 100 / 70	100	1.000

CE CE Certified / Certifié CE / CE Zulassung / Certificado CE / Сертификат CE

Fire Reaction A1 / Réaction au feu A1 / Brandverhalten A1 / Reacción al fuego A1 / Реакция на огонь A1

TM 11

- 🇬🇧 **Pan head 6-lobe recess chipboard screw with special patented thread and reamer (over 100mm), zinc plated and waxed**
- 🇫🇷 Vis tête cylindrique pour panneaux de particules, empreinte à six lobes, avec filetage breveté et alésoir (au-dessus de 100 mm), zinguée et cirée
- 🇩🇪 Spanplatte - Halbrundkopfschraube, Innensechsrund, Gewinde patentiert und Reibahle (ab 100mm), verzinkt und mit Wachs
- 🇪🇸 Tornillo para aglomerado, cabeza cilíndrica 6 lóbulos internos, especial rosca patentada y fresa (a partir de 100mm de longitud), cincado y encerado
- 🇷🇺 Запатентованный оцинкованный шуруп по дереву из закаленной стали с цилиндрической скругленной головкой с шестигранным шлицем, с накаткой (для размеров свыше 100 мм), со специальным восковым покрытием

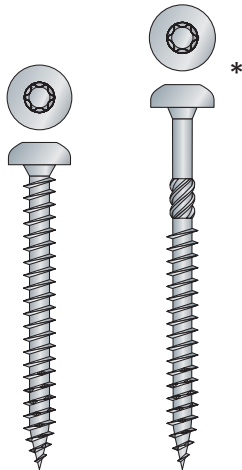

Item code	Screw size Ø x L / L ₁ (mm)	Pcs. per box	Pcs. per carton
Ø 5 / T-25			
CE 🔥 TM 11 50 020	5 x 20	500	5.000
CE 🔥 TM 11 50 025	5 x 25	500	5.000
CE 🔥 TM 11 50 030	5 x 30	500	5.000
CE 🔥 TM 11 50 035	5 x 35	500	5.000
CE 🔥 TM 11 50 040	5 x 40	200	2.000
CE 🔥 TM 11 50 045	5 x 45	200	2.000
CE 🔥 TM 11 50 050	5 x 50	200	2.000
CE 🔥 TM 11 50 060	5 x 60	200	2.000
CE 🔥 TM 11 50 070	5 x 70 / 60	200	2.000
CE 🔥 TM 11 50 080	5 x 80 / 60	200	2.000
CE 🔥 TM 11 50 100	5 x 100 / 70	100	1.000
CE 🔥 TM 11 50 120	5 x 120 / 70	100	1.000
CE 🔥 TM 11 50 140	5 x 140 / 70	100	1.000

CE 🔥 CE Certified / Certifié CE / CE Zulassung / Certificado CE / Сертификат CE
 🔥 Fire Reaction A1 / Réaction au feu A1 / Brandverhalten A1 / Reacción al fuego A1 / Реакция на огонь A1



- 🇬🇧 * With reamer starting from 100 mm length (Ø 5 mm)
- 🇫🇷 * Avec alésoir à partir de la longueur 100 mm (Ø 5 mm)
- 🇩🇪 * Mit Reibahle von der Länge 100 mm (Ø 5 mm)
- 🇪🇸 * Con fresa a partir de la longitud 100 mm (Ø 5 mm)
- 🇷🇺 * С накаткой для размера 100 мм и выше (Ø 5 мм)



CE Certified according to the EN 14592:2008+A1:2012, for structural timber applications. Nominal diameter and technical details in: DoP n. P1210/13-630-1-TM

DoP



One bit free per box



- 🇬🇧 **one bit free per box**
- 🇫🇷 Un embout gratuit dans chaque boîte
- 🇩🇪 Zu jeder Verpackung ein Bit kostenlos
- 🇪🇸 Una punta de atornillar en cada caja
- 🇷🇺 Один бесплатный бит в каждой упаковке

Box / Boîte / Verpackung
Caja / Упаковка

Usage / Utilisation / Benutzung
Uso / Применение



Included in TADS - Tecfi Anchor Design Software for computer aided design of Anchorage.

Tecfi Anchor Design Software
www.tecfi.it/tads

TL

Raised (oval) CSK head with ribs cross type Z recess chipboard screw with special patented thread, waxed

Vis tête fraisée bombée pour panneaux de particules, empreinte cruciforme Type Z, filetage breveté, cirée

Linsensenkopfschraube für Spanplatte, Kreuzschlitz Z, Gewinde patentiert, mit Wachs

Tornillo para aglomerado, cabeza avellanada abombada cruz tipo Z con estrías avellanadoras, especial rosca patentada, encerado

Запатентованный шуруп по дереву из закаленной стали с полупотайной головкой с насечками с крестообразным шлицем типа Z, со специальным восковым покрытием

TL 01 zinc plated / zinguée / verzinkt / cincado / Оцинкованный

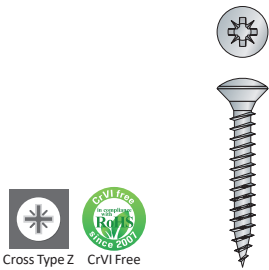

Item code	Screw size Ø x L (mm)	Pcs. per box	Pcs. per carton
Ø 3 / Pz 1			
TL 01 30 016	3 x 16	500	5.000
TL 01 30 020	3 x 20	500	5.000
TL 01 30 025	3 x 25	500	5.000
TL 01 30 030	3 x 30	500	5.000

TL 03 brass plated / laitonée / vermessingt / latonado / латунный

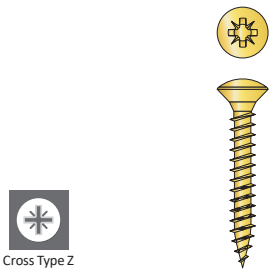

Item code	Screw size Ø x L (mm)	Pcs. per box	Pcs. per carton
Ø 2,5 / Pz 1			
TL 03 25 016	2,5 x 16	500	5.000
TL 03 25 020	2,5 x 20	500	5.000
Ø 3 / Pz 1			
TL 03 30 016	3 x 16	500	5.000
TL 03 30 020	3 x 20	500	5.000
TL 03 30 025	3 x 25	500	5.000
TL 03 30 030	3 x 30	500	5.000
Ø 3,5 / Pz 2			
TL 03 35 020	3,5 x 20	500	5.000
TL 03 35 025	3,5 x 25	500	5.000
TL 03 35 030	3,5 x 30	500	5.000

TL 04 bronze plated / bronzée / bronziert / bronceado / бронзовый

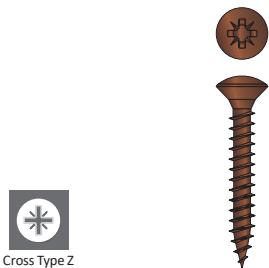

Item code	Screw size Ø x L (mm)	Pcs. per box	Pcs. per carton
Ø 3 / Pz 1			
TL 04 30 016	3 x 16	500	5.000
TL 04 30 020	3 x 20	500	5.000
TL 04 30 025	3 x 25	500	5.000
TL 04 30 030	3 x 30	500	5.000

Box / Boîte / Verpackung / Caja / Упаковка

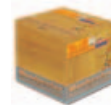

TL 01



TL 03



TL 04

AAA 01

Flat CSK head cross type Z recess chipboard screw, waxed

- Vis tête fraisée plate pour panneaux de particules, empreinte cruciforme type Z, cirée
- Spanplatte-Senkkopfschraube Kreuzschlitz Z, mit Wachs
- Tornillo para aglomerado, cabeza avellanada cruz tipo Z, de acero cementado, encerado, a granel
- Оцинкованный шуруп из закаленной стали с плоской потайной головкой с крестообразным шлицем типа Z, со специальным восковым покрытием

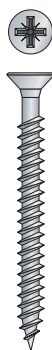

Item code	Screw size Ø x L / L ₁ (mm)	Pcs. per carton
Ø 3,5 / Pz 2		
AAA 01 35 030	3,5 x 30	10.000
AAA 01 35 045	3,5 x 45	5.000
AAA 01 35 050	3,5 x 50	5.000
Ø 4 / Pz 2		
AAA 01 40 018	4 x 18	10.000
AAA 01 40 020	4 x 20	10.000
AAA 01 40 035	4 x 35	5.000
AAA 01 40 040	4 x 40	5.000
AAA 01 40 045	4 x 45	5.000
Ø 4,5 / Pz 2		
AAA 01 45 025	4,5 x 25	10.000
AAA 01 45 040	4,5 x 40	5.000
AAA 01 45 045	4,5 x 45	5.000
AAA 01 45 050	4,5 x 50	5.000
AAA 01 45 055	4,5 x 55	5.000
AAA 01 45 060	4,5 x 60	5.000
Ø 5 / Pz 2		
AAA 01 50 050	5 x 50	5.000
AAA 01 50 060	5 x 60	5.000
AAA 01 50 070	5 x 70 / 60	3.000
Ø 6 / Pz 3		
AAA 01 60 060	6 x 60	3.000
AAA 01 60 070	6 x 70 / 60	3.000
AAA 01 60 080	6 x 80 / 60	3.000

⚠ **Until stockout** / Jusqu'à épuisement des stocks / Solange der Vorrat reicht / Hasta agotar existencias / до окончания стока

Until stockout / Jusqu'à épuisement des stocks / Solange der Vorrat reicht / Hasta agotar existencias / до окончания стока

AAA 02 yellow zinc plated / zingué jaune / gelb Verzinkt / bicromatado / оцинкованный желтого цвета

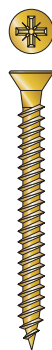

Item code	Screw size Ø x L / L ₁ (mm)	Pcs. per carton
Ø 3,5 / Pz 2		
AAA 02 35 025	3,5 x 25	5.000
Ø 4 / Pz 2		
AAA 02 40 050	4 x 50	5.000

Box / Boîte / Verpackung / Caja / Упаковка



AAD 01

Pan washer head cross type Z recess chipboard screw, waxed

 Vis tête cylindrique pour panneaux de particules, avec rondelle intégrée, empreinte cruciforme type Z, cirée

 Spanplatte- Tellerkopfschraube, Kreuzschlitz Z, mit Wachs

 Tornillo para aglomerado, cabeza cilíndrica cruz tipo Z con arandela estampada, encerado

 Оцинкованный шуруп с полукруглой головкой с пресс-шайбой с крестообразным шлицем типа Z, со специальным восковым покрытием

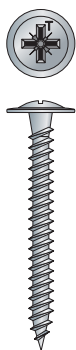

Item code	Screw size $\varnothing \times L / L_1$ (mm)	Pcs. per carton
$\varnothing 3,5 / Pz 2$		
AAD 01 35 030	3,5 x 30	5.000
$\varnothing 4 / Pz 2$		
AAD 01 40 040	4 x 40	5.000
AAD 01 40 045	4 x 45	5.000
$\varnothing 4,5 / Pz 2$		
AAD 01 45 035	4,5 x 35	5.000
AAD 01 45 040	4,5 x 40	5.000
AAD 01 45 045	4,5 x 45	5.000
AAD 01 45 050	4,5 x 50	5.000
AAD 01 45 055	4,5 x 55	5.000
AAD 01 45 060	4,5 x 60	5.000
$\varnothing 5 / Pz 3$		
AAD 01 50 040	5 x 40	5.000
AAD 01 50 045	5 x 45	5.000
AAD 01 50 050	5 x 50	5.000
AAD 01 50 060	5 x 60	3.000
AAD 01 50 070	5 x 70	3.000
$\varnothing 6 / Pz 3$		
AAD 01 60 060	6 x 60	3.000
AAD 01 60 070	6 x 70	3.000
AAD 01 60 080	6 x 80	3.000

Technical
Data Sheet



Box / Boîte / Verpackung / Caja / Упаковка



BA 01

DIN 571 - Hexagonal head wood screw, zinc plated

DIN 571 - Vis à bois tête hexagonale, zinguée

DIN 571 - Sechskant- Holzschraube, verzinkt

DIN 571 - Tornillo para madera, cabeza hexagonal, de acero cincado

DIN 571 - Оцинкованный шуруп с шестигранной головкой

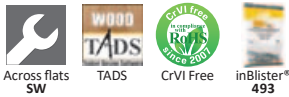
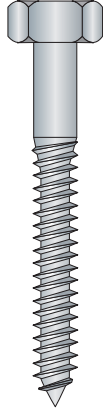

CE Certified according to the **EN 14592:2008+A1:2012**, for structural timber applications. Nominal diameter and technical details in: DoP n. P1210/13-630-1-BA

DoP



Usage / Utilisation / Benutzung / Uso / Применение

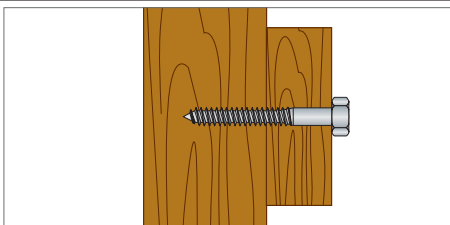

Box / Boîte / Verpackung
Saja / Упаковка

Usage / Utilisation / Benutzung
Uso / Применение



Included in **TADS - Tecfi Anchor Design Software** for computer aided design of Anchorage.

Tecfi Anchor Design Software
www.tecfi.it/tads

Item code	Screw size Ø x L (mm)	Pcs. per box	Pcs. per carton
Ø 6 / SW: 10			
BA 01 06 030	6 x 30	200	2.000
BA 01 06 040	6 x 40	200	2.000
BA 01 06 050	6 x 50	200	2.000
BA 01 06 060	6 x 60	100	1.000
BA 01 06 070	6 x 70	100	1.000
BA 01 06 080	6 x 80	100	1.000
BA 01 06 090	6 x 90	100	1.000
BA 01 06 100	6 x 100	100	1.000
BA 01 06 110	6 x 110	100	1.000
BA 01 06 120	6 x 120	100	1.000
Ø 7 / SW: 12			
BA 01 07 030	7 x 30	200	2.000
BA 01 07 040	7 x 40	200	2.000
BA 01 07 050	7 x 50	100	1.000
BA 01 07 060	7 x 60	100	1.000
BA 01 07 070	7 x 70	100	1.000
BA 01 07 080	7 x 80	100	1.000
BA 01 07 090	7 x 90	100	1.000
BA 01 07 100	7 x 100	100	1.000
BA 01 07 110	7 x 110	100	1.000
BA 01 07 120	7 x 120	100	500
BA 01 07 130	7 x 130	100	500
BA 01 07 150	7 x 150	100	500
Ø 8 / SW: 13			
BA 01 08 040	8 x 40	200	1.000
BA 01 08 050	8 x 50	200	1.000
BA 01 08 060	8 x 60	100	1.000
BA 01 08 070	8 x 70	100	1.000
BA 01 08 080	8 x 80	100	1.000
BA 01 08 090	8 x 90	100	500
BA 01 08 100	8 x 100	100	500
BA 01 08 110	8 x 110	100	500
BA 01 08 120	8 x 120	50	500
BA 01 08 130	8 x 130	50	500
BA 01 08 140	8 x 140	50	500
BA 01 08 150	8 x 150	50	250
BA 01 08 160	8 x 160	50	250
BA 01 08 180	8 x 180	50	250
BA 01 08 200	8 x 200	50	250
BA 01 08 220	8 x 220	50	250
BA 01 08 240	8 x 240	50	250
BA 01 08 250	8 x 250	50	250
Ø 10 / SW: 17			
BA 01 10 050	10 x 50	100	500
BA 01 10 060	10 x 60	100	500
BA 01 10 070	10 x 70	100	500
BA 01 10 080	10 x 80	50	500
BA 01 10 090	10 x 90	50	500
BA 01 10 100	10 x 100	50	250
BA 01 10 120	10 x 120	50	250
BA 01 10 140	10 x 140	50	250
BA 01 10 150	10 x 150	50	250
BA 01 10 160	10 x 160	50	250
BA 01 10 180	10 x 180	50	250
BA 01 10 200	10 x 200	50	250
BA 01 10 220	10 x 220	50	250
BA 01 10 240	10 x 240	-	50
BA 01 10 260	10 x 260	-	50
BA 01 10 280	10 x 280	-	50
BA 01 10 300	10 x 300	-	50
Ø 12 / SW: 19			
BA 01 12 080	12 x 80	50	250
BA 01 12 100	12 x 100	50	250
BA 01 12 120	12 x 120	50	250
BA 01 12 140	12 x 140	50	250
BA 01 12 150	12 x 150	50	250
BA 01 12 160	12 x 160	25	125
BA 01 12 180	12 x 180	25	125
BA 01 12 200	12 x 200	25	125
BA 01 12 260	12 x 260	-	25
BA 01 12 300	12 x 300	-	25
BA 01 12 360	12 x 360	-	20
BA 01 12 400	12 x 400	-	15

CE Certified / *Certifié CE* / *CE Zulassung* / *Certificado CE* / *Сертификат CE*

Fire Reaction A1 / *Réaction au feu A1* / *Brandverhalten A1* / *Reacción al fuego A1* / *Реакция на огонь A1*

BA 02

DIN 571 - Hexagonal head SPECIAL wood screw, zinc plated

DIN 571 - Vis à bois tête hexagonale avec filet SPÉCIAL, zinguée

DIN 571 - Sechskant-Holzschraube mit Spezialgewinde, verzinkt

DIN 571 - Tornillo ESPECIAL para madera, cabeza hexagonal, de acero cincado

DIN 571 - Оцинкованный шуруп с шестигранной головкой со СПЕЦИАЛЬНОЙ резьбой

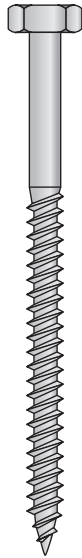

Item code	Screw size Ø x L / L ₁ (mm)	Pcs. per box	Pcs. per carton
Ø 5,5 / SW: 10			
BA 02 55 065	5,5 x 65 / 39	100	1.000
BA 02 55 085	5,5 x 85 / 51	100	1.000
BA 02 55 105	5,5 x 105 / 63	100	1.000
BA 02 55 125	5,5 x 125 / 72	100	1.000
BA 02 55 140	5,5 x 140 / 72	100	1.000
Ø 7 / SW: 12			
BA 02 07 085	7 x 85 / 51	100	1.000
BA 02 07 105	7 x 105 / 63	100	500
BA 02 07 120	7 x 120 / 72	50	500
BA 02 07 140	7 x 140 / 72	50	500
BA 02 07 165	7 x 165 / 72	50	500
BA 02 07 205	7 x 205 / 72	50	500

Usage / Utilisation / Benutzung / Uso / Применение

Box / Boîte / Verpackung / Caja / Упаковка

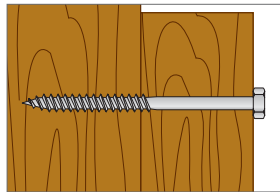

Across flats
SW



CrVI Free
since 2001

BA 03

DIN 571 - Hexagonal head SPECIAL wood screw, hardened, zinc plated

DIN 571 - Vis à bois tête hexagonale avec filet SPÉCIAL, zinguée

DIN 571 - Sechskant- Holzschraube mit Spezialgewinde, verzinkt

DIN 571 - Tornillo ESPECIAL para madera, cabeza hexagonal, de acero cementado, cincado

DIN 571 - Оцинкованный шуруп из закаленной стали с шестигранной головкой со СПЕЦИАЛЬНОЙ резьбой

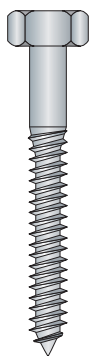

Item code	Screw size Ø x L / L ₁ (mm)	Pcs. per box	Pcs. per carton
Ø 6 / SW: 10			
BA 03 06 050	6 x 50 / 39	200	2.000
Ø 7 / SW: 12			
BA 03 07 065	7 x 65 / 50	100	1.000
Ø 8 / SW: 13			
BA 03 08 070	8 x 70 / 59	100	1.000
Ø 10 / SW: 17			
BA 03 10 100	10 x 100 / 75	50	500
BA 03 10 120	10 x 120 / 85	50	250
Ø 12 / SW: 19			
BA 03 12 100	12 x 100 / 75	50	250

Usage / Utilisation / Benutzung / Uso / Применение

Box / Boîte / Verpackung / Caja / Упаковка

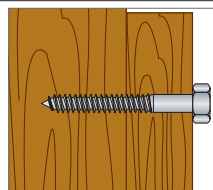

Across flats
SW



CrVI Free
since 2001

AAC 01

Flat countersunk head cross type Z recess wood screw, zinc plated

- 🇫🇷 Vis à bois tête fraisée plate empreinte cruciforme type Z, zinguée
- 🇩🇪 Senkkopf- Holzschraube, Kreuzschlitz Z, verzinkt
- 🇵🇪 Tornillo para madera, cabeza avellanada cruz tipo Z, de acero cincado
- 🇷🇺 Оцинкованный шуруп с плоской потайной головкой с крестообразным шлицем типа Z

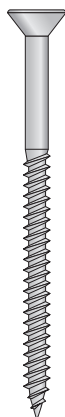

Item code	Screw size Ø x L (mm)	Pcs. per box	Pcs. per carton
Ø 4 / Pz 2			
AAC 01 40 045	4 x 45	200	2.000
AAC 01 40 065	4 x 65	200	2.000
AAC 01 40 085	4 x 85	200	2.000
Ø 5,5 / Pz 3			
AAC 01 55 065	5,5 x 65	200	2.000
AAC 01 55 085	5,5 x 85	200	2.000
AAC 01 55 105	5,5 x 105	100	1.000
AAC 01 55 125	5,5 x 125	100	1.000
AAC 01 55 140	5,5 x 140	100	1.000
Ø 7 / Pz 4			
AAC 01 70 065	7 x 65	100	1.000
AAC 01 70 085	7 x 85	100	1.000
AAC 01 70 105	7 x 105	100	500
AAC 01 70 120	7 x 120	100	500
AAC 01 70 140	7 x 140	50	500
AAC 01 70 165	7 x 165	50	500
AAC 01 70 205	7 x 205	50	500

Box / Boîte / Verpackung / Caja / Упаковка



AAC 03

Flat countersunk head 6-lobe recess wood screw, zinc plated

- 🇫🇷 Vis à bois tête fraisée plate empreinte à six lobes, zinguée
- 🇩🇪 Senkkopf- Holzschraube mit Innensechsrund, verzinkt
- 🇵🇪 Tornillo para madera, cabeza avellanada 6 lóbulos internos, de acero cincado
- 🇷🇺 Оцинкованный шуруп с плоской потайной головкой с шестигранным шлицем

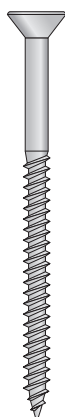

Item code	Screw size Ø x L (mm)	Pcs. per box	Pcs. per carton
Ø 5,5 / T-30			
AAC 03 55 065	5,5 x 65	200	2.000
AAC 03 55 085	5,5 x 85	200	2.000
AAC 03 55 105	5,5 x 105	100	1.000
AAC 03 55 125	5,5 x 125	100	1.000
AAC 03 55 140	5,5 x 140	100	1.000
Ø 7 / T-40			
AAC 03 70 085	7 x 85	100	1.000
AAC 03 70 105	7 x 105	100	500
AAC 03 70 120	7 x 120	100	500
AAC 03 70 140	7 x 140	50	500
AAC 03 70 165	7 x 165	50	500
AAC 03 70 205	7 x 205	50	500

Box / Boîte / Verpackung / Caja / Упаковка



LD 01

🇬🇧 Mushroom head 6-lobe recess special and hardened wood screw, zinc plated

- 🇫🇷 Vis spéciale à bois tête bombée à six lobes, en acier cimenté, zinguée
- 🇩🇪 Spezielle Rundkopf- Holzschraube mit Innensechsrund, einsatzgehärtet, verzinkt
- 🇪🇸 Tornillo especial para madera, cabeza abombada 6 lóbulos internos, de acero cementado, cincado
- 🇷🇺 Оцинкованный шуруп из закаленной стали с низкой полукруглой головкой с шестигранным шлицем

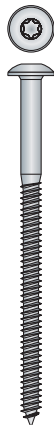

Item code	Screw size Ø x L / L ₁ (mm)	Pcs. per box	Pcs. per carton
Ø 7 / T-40			
LD 01 70 065	7 x 65 / 39	100	1.000
LD 01 70 085	7 x 85 / 51	100	1.000
LD 01 70 105	7 x 105 / 63	100	1.000
LD 01 70 120	7 x 120 / 72	50	500
LD 01 70 140	7 x 140 / 84	50	500
LD 01 70 165	7 x 165 / 99	50	500
LD 01 70 205	7 x 205 / 99	50	500

LD 02 with T-40 6-lobe shaped small cap to be hammered
avec cache-tête à six lobes X T-40 à marteler / mit T-40 Einschlagstern / con tapón clavable T-40 / с ударным колпачком -заглушкой T-40 под шестигранный шлиц



Item code	Screw size Ø x L / L ₁ (mm)	Pcs. per box	Pcs. per carton
Ø 7 / T-40			
LD 02 70 065	7 x 65 / 39	100	1.000
LD 02 70 085	7 x 85 / 51	100	1.000
LD 02 70 105	7 x 105 / 63	100	1.000
LD 02 70 120	7 x 120 / 72	50	500
LD 02 70 140	7 x 140 / 84	50	500
LD 02 70 165	7 x 165 / 99	50	500
LD 02 70 205	7 x 205 / 99	50	500

Box / Boîte / Verpackung / Caja / Упаковка



LB 01

🇬🇧 T-30 and T-40 6-lobe shaped small cap fitting 6-lobe recessed screw, to be hammered

- 🇫🇷 Cache-tête à six lobes X T-30 et T-40 pour vis à six lobes, à marteler
- 🇩🇪 T-30 und T-40 Einschlagstern
- 🇪🇸 Tapón clavable para tornillos con cabeza 6 lóbulos internos T-30 y T-40
- 🇷🇺 Ударный колпачок-заглушка T-30 и T-40 под шестигранный шлиц



Item code	Size	Pcs. per bag	Pcs. per box
LB 01 00 030	T-30	100	5.000
LB 01 00 040	T-40	50	2.500

Box / Boîte / Verpackung / Caja / Упаковка



IV 01 - IX 01 - IW 01

 **Special wood screw for VS-Handyplug® anchors, zinc plated**

 Vis à bois spéciale pour chevilles VS-Handyplug®, zinguée

 Spezielle verzinkte Holzschraube für VS-Handyplug® Nylondübel

 Tornillo especial para madera, para tacos VS-Handyplug®, cincado

 Специальный оцинкованный шуруп для дюбелей VS-Handyplug®

IV 01 6-lobe recess flat countersunk head / Tête fraisée empreinte six lobes X / Senkkopf mit Innensechsrund / cabeza avellanada 6 lóbulos internos / шуруп с плоской потайной головкой и шестигранным шлицем

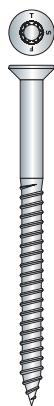

Item code	Screw size Ø x L / L ₁ (mm)	Pcs. per box	Pcs. per carton
Ø 8 / T-30			
IV 01 60 085	6 x 85 / 75	200	1.000
IV 01 60 105	6 x 105 / 75	100	500
IV 01 60 125	6 x 125 / 75	100	500
IV 01 60 145	6 x 145 / 75	100	500
Ø 10 / T-40			
IV 01 70 085	7 x 85 / 75	100	500
IV 01 70 105	7 x 105 / 75	100	500
IV 01 70 125	7 x 125 / 75	100	500
IV 01 70 145	7 x 145 / 75	50	500
IV 01 70 165	7 x 165 / 75	50	250
IV 01 70 205	7 x 205 / 75	50	250
IV 01 70 235	7 x 235 / 75	25	250

IX 01 6-lobe recess hexagonal washer head / Tête hexagonale empreinte six lobes X / Sechskantkopf mit Innensechsrund / cabeza hexagonal arandela estampada 6 lóbulos internos / шуруп с шестигранной головкой и шестигранным шлицем

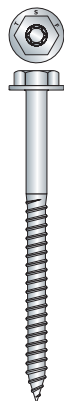

Item code	Screw size Ø x L / L ₁ (mm)	Pcs. per box	Pcs. per carton
Ø 8 / SW: 10 / T-30			
IX 01 60 085	6 x 85 / 75	100	1.000
IX 01 60 105	6 x 105 / 75	100	500
IX 01 60 125	6 x 125 / 75	50	500
IX 01 60 145	6 x 145 / 75	50	500
Ø 10 / SW: 13 / T-40			
IX 01 70 085	7 x 85 / 75	100	500
IX 01 70 105	7 x 105 / 75	100	500
IX 01 70 125	7 x 125 / 75	50	500
IX 01 70 145	7 x 145 / 75	50	250
IX 01 70 165	7 x 165 / 75	50	250
IX 01 70 205	7 x 205 / 75	50	250
IX 01 70 235	7 x 235 / 75	25	250

IW 01 6-lobe recess mushroom head / Tête ronde empreinte six lobes X / Rundkopf mit Innensechsrund / cabeza abombada 6 lóbulos internos / Шуруп с низкой полукруглой головкой с шестигранным шлицем

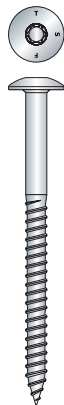

Item code	Screw size Ø x L / L ₁ (mm)	Pcs. per box	Pcs. per carton
Ø 8 / T-30			
IW 01 60 085	6 x 85 / 75	100	1.000
IW 01 60 105	6 x 105 / 75	100	500
IW 01 60 125	6 x 125 / 75	50	500
IW 01 60 145	6 x 145 / 75	50	500
Ø 10 / T-40			
IW 01 70 085	7 x 85 / 75	100	500
IW 01 70 105	7 x 105 / 75	100	500
IW 01 70 125	7 x 125 / 75	50	250
IW 01 70 145	7 x 145 / 75	50	250
IW 01 70 165	7 x 165 / 75	50	250
IW 01 70 205	7 x 205 / 75	50	250

RN 01- PX 01

 **Special wood screw for VS-Handyplug® anchors, zinc plated**

 Vis à bois spéciale pour chevilles VS-Handyplug®, zinguée



 Spezielle verzinkte Holzschraube für VS-Handyplug® Nylondübel

 Tornillo especial para madera, para tacos VS-Handyplug®, cincado

 Специальный оцинкованный шуруп для дюбелей VS-Handyplug®

RN 01 socket recess dual thread (machine + special) screw / vis double filet (métrique et spécial) à six pans creux / Innensechskantschraube mit doppeltem Gewinde (metrisches und spezielles) / Tornillo doble rosca (métrica + especial), con huella hexagonal / Оцинкованный двухсторонний шуруп с внутренним шестигранником



Item code	Dual thread screw $\varnothing \times L / M \times L_m$ (mm)	Pcs. per box	Pcs. per carton
$\varnothing 6/M6 / SW: 10 /$ In hex (s): 3			
 RN 01 60 110	$\varnothing 6 \times 85 / M6 \times 21$	100	1.000
$\varnothing 7/M8 / SW: 13 /$ In hex (s): 4			
 RN 01 70 115	$\varnothing 7 \times 85 / M8 \times 25$	50	500

 with hex recess until stockout, then **WITHOUT hex recess** / à six pans creux jusqu'à épuisement de stock, après sans six pans creux / Mit Sechseckeinbuchtung bis Lagerende geliefert, danach ohne Sechseckeinbuchtung geliefert / con huella hexagonal hasta agotar existencias. Luego se entregará el producto sin huella / с внутренним шестигранником до конца стока, потом без внутреннего шестигр

PX 01 socket recess dual thread (machine + special) screw / vis double filet (métrique et spécial) à six pans creux / Innensechskantschraube mit Doppelgewinde (metrisch und spezial) / Tornillo doble rosca (métrica + especial), con huella hexagonal / Оцинкованный двухсторонний шуруп с внутренним шестигранником



Item code	Dual thread screw $\varnothing \times L / M \times L_m$ (mm)	Pcs. per box	Pcs. per carton
$\varnothing 7/M8 / SW: 13 /$ without In hex			
PX 01 70 165	$\varnothing 7 \times 165 / M8 \times 20$	50	500
PX 01 70 205	$\varnothing 7 \times 205 / M8 \times 20$	50	500

IV 71 - IX 71 - RN 71

🇬🇧 A4-70 (AISI 316) stainless steel special wood screw for VS-Handyplug® anchors

🇫🇷 Vis à bois spéciale pour chevilles VS-Handyplug®, en acier Inox A4-70 (AISI 316)

🇩🇪 Spezielle Holzschraube aus Edelstahl A4-70 (AISI 316) für VS-Handyplug® Nyldübel

🇪🇸 Tornillo especial para madera, para tacos VS-Handyplug®, de Acero Inoxidable A4-70 (AISI 316)

🇷🇺 Специальный шуруп из нержавеющей стали A4-70 (AISI 316) для дюбелей VS-Handyplug®

IV 71 6-lobe recess flat countersunk head / Tête fraisée empreinte six lobes X / Senkkopf mit Innensechsrund / cabeza avellanada 6 lóbulos internos / шуруп с плоской потайной головкой и шестигранным шлицем



Item code	Screw size Ø x L / L ₁ (mm)	Pcs. per box	Pcs. per carton
Ø 8 / T-30			
IV 71 60 085	6 x 85 / 75	200	1.000
IV 71 60 105	6 x 105 / 75	100	500
IV 71 60 125	6 x 125 / 75	100	500
IV 71 60 145	6 x 145 / 75	100	500
Ø 10 / T-40			
IV 71 70 085	7 x 85 / 75	100	500
IV 71 70 105	7 x 105 / 75	100	500
IV 71 70 125	7 x 125 / 75	100	500
IV 71 70 145	7 x 145 / 75	50	250
IV 71 70 165	7 x 165 / 75	50	250
IV 71 70 205	7 x 205 / 75	50	250
IV 71 70 235	7 x 235 / 75	25	250

IX 71 6-lobe recess hexagonal washer head / Tête hexagonale empreinte six lobes X / Sechskantkopf mit Innensechsrund / cabeza hexagonal arandela estampada 6 lóbulos internos / шуруп с шестигранной головкой и шестигранным шлицем



Item code	Screw size Ø x L / L ₁ (mm)	Pcs. per box	Pcs. per carton
Ø 8 / SW: 10 / T-30			
IX 71 60 085	6 x 85 / 75	100	1.000
IX 71 60 105	6 x 105 / 75	100	500
IX 71 60 125	6 x 125 / 75	50	500
IX 71 60 145	6 x 145 / 75	50	500
Ø 10 / SW: 13 / T-40			
IX 71 70 085	7 x 85 / 75	100	500
IX 71 70 105	7 x 105 / 75	100	500
IX 71 70 125	7 x 125 / 75	50	250
IX 71 70 145	7 x 145 / 75	50	250
IX 71 70 165	7 x 165 / 75	50	250
IX 71 70 205	7 x 205 / 75	50	250
IX 71 70 235	7 x 235 / 75	25	250



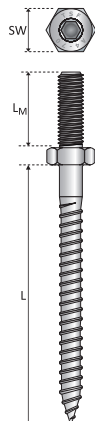

RN 71 socket recess dual thread (machine + special) screw / vis double filet (métrique et spécial) à six pans creux / Innensechskantschraube mit Doppelgewinde (metrisch und spezial) / Tornillo doble rosca (métrica + especial), con huella hexagonal / Оцинкованный двухсторонний шуруп с внутренним шестигранником



Item code	Screw size Ø x L / M x L _M (mm)	Pcs. per box	Pcs. per carton
Ø 6/M6 / SW: 10 / In hex (s): 3			
RN 71 60 110	Ø6 x 85 / M6 x 21	100	1.000
Ø 7/M8 / SW: 13 / In hex (s): 4			
RN 71 70 115	Ø7 x 85 / M8 x 25	50	500

EA 01

“L” shaped wood screw (undersized body), zinc plated

-  Vis crochet droit à bois, zinguée
-  Holzschraube mit Haken, verzinkt
-  Alcayata con rosca para madera, cincada
-  Оцинкованный костыль-шуруп

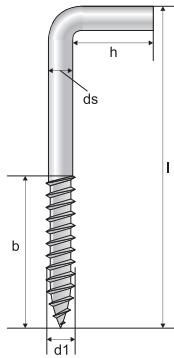





Box / Boîte / Verpackung / Caja / Упаковка



Item code	Size number	Wire Ø (ds) (mm)	Thread Ø (d1) (mm)	Length (l) (mm)	Thread length (b) (mm)	Height (h) (mm)	Pcs. per Box	Pcs. per carton
EA 01 14 025	14 x 25	2	2,5	15	10	6	500	5.000
EA 01 14 030	14 x 30	2	2,5	20	10	6	500	5.000
EA 01 16 030	16 x 30	2,25	3	20	10	7,5	500	5.000
EA 01 16 035	16 x 35	2,25	3	25	10	7,5	500	5.000
EA 01 17 030	17 x 30	2,5	3,3	20	10	8,5	200	2.000
EA 01 17 035	17 x 35	2,5	3,3	25	10	8,5	200	2.000
EA 01 17 040	17 x 40	2,5	3,3	30	10	8,5	200	2.000
EA 01 18 040	18 x 40	3	4,2	30	10	10	200	2.000
EA 01 18 045	18 x 45	3	4,2	35	15	10	200	2.000
EA 01 18 050	18 x 50	3	4,5	40	15	10	200	2.000
EA 01 19 050	19 x 50	3,5	4,5	35	15	12	200	2.000
EA 01 19 060	19 x 60	3,5	4,5	45	18	12	200	2.000
EA 01 20 050	20 x 50	4	5	35	15	13	200	2.000
EA 01 20 060	20 x 60	4	5	45	18	13	200	2.000
EA 01 20 070	20 x 70	4	5	55	21	13	200	2.000
EA 01 20 080	20 x 80	4	5	65	21	13	200	2.000
EA 01 21 060	21 x 60	4,5	5,5	45	18	14	200	2.000
EA 01 21 070	21 x 70	4,5	5,5	55	21	14	200	2.000
EA 01 21 080	21 x 80	4,5	5,5	60	21	14	200	2.000
EA 01 21 100	21 x 100	4,5	5,5	80	24	14	100	1.000
EA 01 22 070	22 x 70	5	6	50	21	17	100	1.000
EA 01 22 080	22 x 80	5	6	60	21	17	100	1.000
EA 01 22 100	22 x 100	5	6	80	24	17	100	1.000
EA 01 23 080	23 x 80	6	7,5	60	24	20	100	1.000
EA 01 23 100	23 x 100	6	7,5	80	30	20	100	1.000
EA 01 23 120	23 x 120	6	7,5	100	30	20	100	1.000

FU 01

Hook wood screw (undersized body), zinc plated

-  Vis crochet rond à bois, zinguée
-  Holzschraube mit Rundhaken, verzinkt
-  Hembrilla abierta con rosca para madera, cincada
-  Оцинкованное полукольцо-шуруп

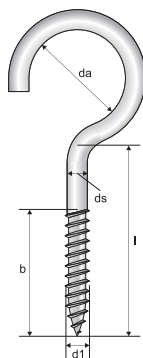

Box / Boîte / Verpackung / Caja / Упаковка



Item code	Size number	Wire Ø (ds) (mm)	Thread Ø (d1) (mm)	Length (l) (mm)	Thread length (b) (mm)	Ø Hook (da) (mm)	Pcs. per Box	Pcs. per carton
FU 01 14 025	14 x 25	2	2,5	10	8	4	500	5.000
FU 01 14 030	14 x 30	2	2,5	15	8	5	500	5.000
FU 01 16 030	16 x 30	2,25	3	10	8	5	500	5.000
FU 01 17 035	17 x 35	2,5	3,3	12	8	7	200	2.000
FU 01 17 040	17 x 40	2,5	3,3	16	10	7	200	2.000
FU 01 18 050	18 x 50	3	4,2	20	10	12	200	2.000
FU 01 18 060	18 x 60	3	4,2	25	15	12	200	2.000
FU 01 19 060	19 x 60	3,5	4,5	20	12	12	200	2.000
FU 01 19 070	19 x 70	3,5	4,5	25	15	12	200	2.000
FU 01 19 080	19 x 80	3,5	4,5	30	15	17	200	2.000
FU 01 20 070	20 x 70	4	5	25	15	14	200	2.000
FU 01 20 080	20 x 80	4	5	30	18	17	200	2.000
FU 01 20 090	20 x 90	4	5	35	18	17	200	2.000
FU 01 21 080	21 x 80	4,5	5,5	30	18	19	200	2.000
FU 01 21 090	21 x 90	4,5	5,5	35	18	19	100	1.000
FU 01 21 100	21 x 100	4,5	5,5	40	24	19	100	1.000
FU 01 22 090	22 x 90	5	6	30	18	21	100	1.000
FU 01 22 100	22 x 100	5	6	35	18	21	100	1.000
FU 01 22 120	22 x 120	5	6	50	30	23	100	1.000

GG 01

Eye wood screw (undersized body), zinc plated

Vis oeillet à bois, zinguée

Holzschraube mit Auge, verzinkt

Hembrilla cerrada con rosca para madera, cincada

Оцинкованное кольцо-шуруп

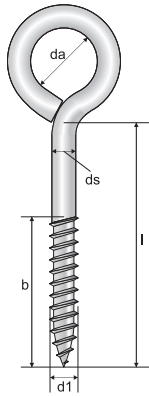

Box / Boîte / Verpackung / Caja / Упаковка



Item code	Size number	Wire Ø (ds) (mm)	Thread Ø (d1) (mm)	Length (l) (mm)	Thread length (b) (mm)	Eye Ø (da) (mm)	Pcs. per Box	Pcs. per carton
GG 01 14 025	14 x 25	2	2,5	10	8	4	500	5.000
GG 01 14 030	14 x 30	2	2,5	12	8	5	500	5.000
GG 01 16 030	16 x 30	2,25	3	12	8	5	500	5.000
GG 01 17 035	17 x 35	2,5	3,3	12	8	6	200	2.000
GG 01 17 040	17 x 40	2,5	3,3	16	10	6	200	2.000
GG 01 17 050	17 x 50	2,5	3,3	20	13	8	200	2.000
GG 01 18 040	18 x 40	3	4,2	16	10	7	200	2.000
GG 01 18 050	18 x 50	3	4,2	20	10	9	200	2.000
GG 01 18 060	18 x 60	3	4,2	25	15	9	200	2.000
GG 01 19 050	19 x 50	3,5	4,5	20	12	9	200	2.000
GG 01 19 060	19 x 60	3,5	4,5	25	15	9	200	2.000
GG 01 19 070	19 x 70	3,5	4,5	30	18	10	200	2.000
GG 01 20 060	20 x 60	4	5	20	15	10	200	2.000
GG 01 20 070	20 x 70	4	5	25	15	10	200	2.000
GG 01 20 080	20 x 80	4	5	30	18	10	200	2.000
GG 01 20 090	20 x 90	4	5	35	18	12	200	2.000
GG 01 21 070	21 x 70	4,5	5,5	25	18	12	200	2.000
GG 01 21 080	21 x 80	4,5	5,5	30	18	12	200	2.000
GG 01 21 090	21 x 90	4,5	5,5	35	18	12	200	2.000
GG 01 22 080	22 x 80	5	6	30	18	14	100	1.000
GG 01 22 100	22 x 100	5	6	40	24	14	100	1.000
GG 01 22 120	22 x 120	5	6	50	30	14	100	1.000
GG 01 23 080	23 x 80	6	7,5	25	18	14	100	1.000
GG 01 23 100	23 x 100	6	7,5	40	24	16	100	1.000
GG 01 23 120	23 x 120	6	7,5	50	30	16	100	1.000
GG 01 23 140	23 x 140	6	7,5	60	36	16	50	500

GG 03

Eye wood screw (undersized body), brass plated

Vis oeillet à bois, bronzée

Holzschraube mit Auge, bronziert

Hembrilla cerrada con rosca para madera, latonada

Латунное кольцо-шуруп

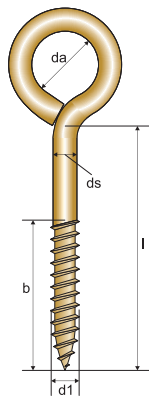





Item code	Size number	Wire Ø (ds) (mm)	Thread Ø (d1) (mm)	Length (l) (mm)	Thread length (b) (mm)	Eye Ø (da) (mm)	Pcs. per Box	Pcs. per carton
GG 03 00 020	n.d.	1,65	2	9	6	3	500	5.000
GG 03 14 025	14 x 25	2	2,5	10	8	4	500	5.000
GG 03 14 030	14 x 30	2	2,5	12	8	5	500	5.000
GG 03 17 035	17 x 35	2,5	3,3	12	8	6	500	5.000
GG 03 17 040	17 x 40	2,5	3,3	16	10	6	500	5.000
GG 03 17 050	17 x 50	2,5	3,3	20	13	8	500	5.000
GG 03 18 040	18 x 40	3	4,2	16	10	7	200	2.000
GG 03 18 050	18 x 50	3	4,2	20	10	9	200	2.000

Box / Boîte / Verpackung / Caja / Упаковка



LI 03

Special "L" shaped wood screw with ring, brass plated

-  Vis crochet droit spéciale à bois avec anneau, bronzée
-  Spezielle Holzschraube mit Haken und Ring, bronziert
-  Alcayata especial con rosca para madera, con anillo, latonada
-  Латунный костыль-шуруп специальной формы с кольцом

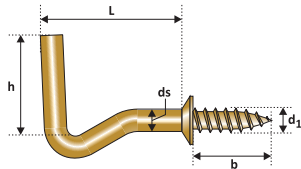





Item code	Wire Ø (ds) (mm)	Thread Ø (d1) (mm)	Length (l) (mm)	Thread length (b) (mm)	Height (h) (mm)	Pcs. per Box	Pcs. per carton
LI 03 24 007	2,5	3	15	7	11	500	5.000
LI 03 24 010	2,5	3	17	10	11	500	5.000

Box / Boîte / Verpackung / Caja / Упаковка



HJI - HWI - JWI - FWI

Special screw with ring, bulk packing

-  Vis spéciale avec anneau, emballage vrac
-  Spezielle Schraube mit Ring, lose Verpackung
-  Tornillo especial con anillo, a granel
-  Специальный шуруп, в индустриальной упаковке

HJI 01 short "L" screw / crochet droit court / Kurzer Haken / gancho corto / с коротким крюком

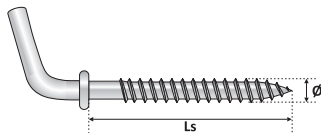

Item code	Screw size Ø x L (mm)	Bags per carton
HJI 01 45 035	4,5 x 35	1.000

HWI 01 medium "L" screw / crochet droit longueur moyenne / Mittelhaken / gancho medio / с крюком

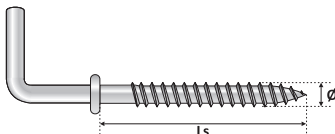

Item code	Screw size Ø x L (mm)	Bags per carton
HWI 01 45 035	4,5 x 35	1.000

JWI 01 hook screw / crochet rond / Rundhaken / gancho curvo / с потолочным крюком

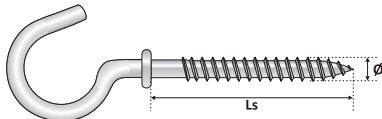

Item code	Screw size Ø x L (mm)	Bags per carton
JWI 01 45 035	4,5 x 35	1.000

FWI 01 eye screw / oeillet / Augenschraube / argolla / с замкнутым крюком

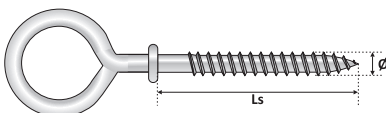

Item code	Screw size Ø x L (mm)	Bags per carton
FWI 01 45 035	4,5 x 35	1.000

Box / Boîte / Verpackung / Caja / Упаковка



JN 01

 Adhesive coloured round cover for screw

 Adhésif coloré pour vis

 Gefärbte Aufkleber für Schrauben

 Tapón adhesivo colorado para tornillos

 Цветная круглая наклейка для шурупов



JN 01 xx 013

Ø 13 mm



JN 01 xx 020

Ø 20 mm



JN 01 xx 025

Ø 25 mm

Box / Boîte / Verpackung / Caja / Упаковка

















Item code	Diameter Ø (mm)	Finishing	Pcs. per box	Pcs. per carton
Diameter: 13 mm				
JN 01 01 013	13	White	1.000	10.000
JN 01 02 013	13	Black	1.000	10.000
JN 01 03 013	13	Brown	1.000	10.000
JN 01 04 013	13	Light grey	1.000	10.000
JN 01 05 013	13	Grey RAL 9006	1.000	10.000
JN 01 06 013	13	Ivory	1.000	10.000
JN 01 07 013	13	Light Cherry	1.000	10.000
JN 01 08 013	13	Dark Cherry	1.000	10.000
JN 01 09 013	13	Hazel	1.000	10.000
JN 01 10 013	13	Beech	1.000	10.000
JN 01 11 013	13	Wenge	1.000	10.000
JN 01 12 013	13	Oak	1.000	10.000
JN 01 13 013	13	Whitened Oak	1.000	10.000
JN 01 14 013	13	Light Ash	1.000	10.000
JN 01 15 013	13	Fir Tree	1.000	10.000
JN 01 16 013	13	Mahogany	1.000	10.000
JN 01 17 013	13	Pear Tree	1.000	10.000
JN 01 18 013	13	Dark Walnut	1.000	10.000
JN 01 19 013	13	Rosewood	1.000	10.000
JN 01 20 013	13	Teak	1.000	10.000
Diameter: 20 mm				
JN 01 01 020	20	White	450	4.500
JN 01 02 020	20	Black	450	4.500
JN 01 03 020	20	Brown	450	4.500
JN 01 04 020	20	Light grey	450	4.500
JN 01 05 020	20	Grey RAL 9006	450	4.500
JN 01 06 020	20	Ivory	450	4.500
JN 01 07 020	20	Light Cherry	450	4.500
JN 01 08 020	20	Dark Cherry	450	4.500
JN 01 09 020	20	Hazel	450	4.500
JN 01 10 020	20	Beech	450	4.500
JN 01 11 020	20	Wenge	450	4.500
JN 01 12 020	20	Oak	450	4.500
JN 01 13 020	20	Whitened Oak	450	4.500
JN 01 14 020	20	Light Ash	450	4.500
JN 01 15 020	20	Fir Tree	450	4.500
JN 01 16 020	20	Mahogany	450	4.500
JN 01 17 020	20	Pear Tree	450	4.500
JN 01 18 020	20	Dark Walnut	450	4.500
JN 01 19 020	20	Rosewood	450	4.500
JN 01 20 020	20	Teak	450	4.500
Diameter: 25 mm				
JN 01 01 025	25	White	300	3.000
JN 01 02 025	25	Black	300	3.000
JN 01 03 025	25	Brown	300	3.000
JN 01 04 025	25	Light grey	300	3.000
JN 01 05 025	25	Grey RAL 9006	300	3.000
JN 01 06 025	25	Ivory	300	3.000
JN 01 07 025	25	Light Cherry	300	3.000
JN 01 08 025	25	Dark Cherry	300	3.000
JN 01 09 025	25	Hazel	300	3.000
JN 01 10 025	25	Beech	300	3.000
JN 01 11 025	25	Wenge	300	3.000
JN 01 12 025	25	Oak	300	3.000
JN 01 13 025	25	Whitened Oak	300	3.000
JN 01 14 025	25	Light Ash	300	3.000
JN 01 15 025	25	Fir Tree	300	3.000
JN 01 16 025	25	Mahogany	300	3.000
JN 01 17 025	25	Pear Tree	300	3.000
JN 01 18 025	25	Dark Walnut	300	3.000
JN 01 19 025	25	Rosewood	300	3.000
JN 01 20 025	25	Teak	300	3.000



▶ All colours are available in the diameters 13, 20 and 25 mm

ADHESIVE ROUND COLOURED SCREW COVERS

				
JN 01 01 - White	JN 01 02 - Black	JN 01 03 - Brown	JN 01 04 - Light Grey	JN 01 05 - Grey RAL 9006
				
JN 01 06 - Ivory	JN 01 07 - Light Cherry	JN 01 08 - Dark Cherry	JN 01 09 - Hazel	JN 01 10 - Beech
				
JN 01 11 - Wenge	JN 01 12 - Oak	JN 01 13 - Whitened Oak	JN 01 14 - Light Ash	JN 01 15 - Fir Tree
				
JN 01 16 - Mahogany	JN 01 17 - Pear Tree	JN 01 18 - Dark Walnut	JN 01 19 - Rosewood Tree	JN 01 20 - Teak

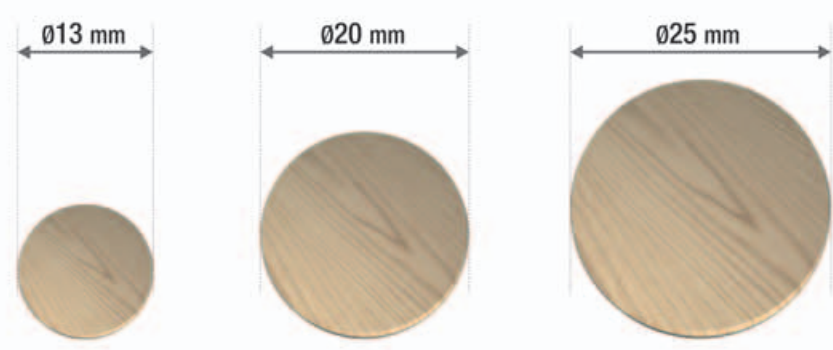

KT 2

Pre-galvanized steel Joist Hanger with Open Wings

- 🇫🇷 Sabot prézingué à ailes extérieures
- 🇩🇪 Vorverzinkte Balkenschuhe, einteilig, nach außen abgewickelt
- 🇪🇸 Soporte con alas exteriores para vigas de madera, de acero pregalvanizado
- 🇷🇺 Опора бруса раскрытая, оцинкованная

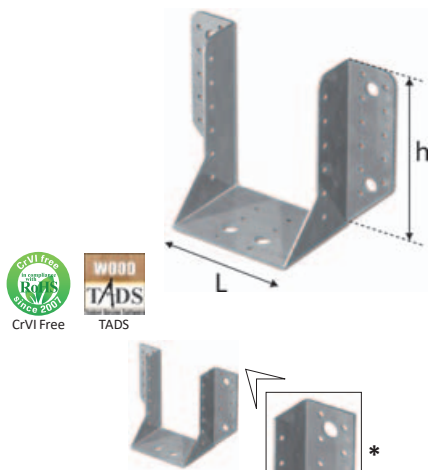

- * Some sizes without rounded edges
- 🇫🇷 Quelques mesures n'ont pas les angles arrondis
 - 🇩🇪 Einige Größe haben keine runde Winkel
 - 🇪🇸 Algunas medidas no tienen ángulos redondeados
 - 🇷🇺 Для некоторых размеров не предусматриваются закругленные углы



Item code	Size	Thickness* (mm)	Holes diameter (mm)		Pcs. per carton
	L x h (mm)				
KT 20 40 070	40 x 70	2	5	13	24
🇫🇷🇩🇪🇪🇸🇷🇺 KT 20 40 110	40 x 110	2	5	11	24
🇫🇷🇩🇪🇪🇸🇷🇺 KT 20 50 105	50 x 105	2	5	11	24
🇫🇷🇩🇪🇪🇸🇷🇺 KT 20 50 135	50 x 135	2	5	11	24
🇫🇷🇩🇪🇪🇸🇷🇺 KT 20 50 165	50 x 165	2	5	13	24
🇫🇷🇩🇪🇪🇸🇷🇺 KT 20 60 100	60 x 100	2	5	11	24
🇫🇷🇩🇪🇪🇸🇷🇺 KT 20 60 130	60 x 130	2	5	11	24
🇫🇷🇩🇪🇪🇸🇷🇺 KT 20 60 160	60 x 160	2	5	13	24
🇫🇷🇩🇪🇪🇸🇷🇺 KT 20 64 098	64 x 98	2	5	11	24
🇫🇷🇩🇪🇪🇸🇷🇺 KT 20 70 125	70 x 125	2	5	11	24
🇫🇷🇩🇪🇪🇸🇷🇺 KT 20 70 155	70 x 155	2	5	13	24
🇫🇷🇩🇪🇪🇸🇷🇺 KT 20 76 122	76 x 122	2	5	11	24
🇫🇷🇩🇪🇪🇸🇷🇺 KT 20 80 120	80 x 120	2	5	11	24
🇫🇷🇩🇪🇪🇸🇷🇺 KT 20 80 150	80 x 150	2	5	13	24
🇫🇷🇩🇪🇪🇸🇷🇺 KT 20 80 180	80 x 180	2	5	13	24
🇫🇷🇩🇪🇪🇸🇷🇺 KT 20 90 115	90 x 115	2	5	11	24
🇫🇷🇩🇪🇪🇸🇷🇺 KT 20 90 145	90 x 145	2	5	13	24
🇫🇷🇩🇪🇪🇸🇷🇺 KT 21 00 110	100 x 110	2	5	13	24
🇫🇷🇩🇪🇪🇸🇷🇺 KT 21 00 140	100 x 140	2	5	13	24
🇫🇷🇩🇪🇪🇸🇷🇺 KT 21 20 160	120 x 160	2	5	13	18
🇫🇷🇩🇪🇪🇸🇷🇺 KT 21 20 190	120 x 190	2	5	13	18
🇫🇷🇩🇪🇪🇸🇷🇺 KT 21 40 180	140 x 180	2	5	13	18

🇫🇷🇩🇪🇪🇸🇷🇺 ETA-CE Certified / Certifié ETA-CE / ETA-CE Zulassung / Certificado ETA-CE / Сертификат ETA-CE

🇫🇷🇩🇪🇪🇸🇷🇺 Fire Reaction A1 / Réaction au feu A1 / Brandverhalten A1 / Reacción al fuego A1 / Реакция на огонь A1

* 2,5 mm thickness available on request / Disponible sur demande (prix et délai de livraison à concorder) aussi avec épaisseur 2,5mm mit Dicke 2,5mm (Preise und Liefertermin zu vereinbaren) auf Anfrage / Grosor 2,5 mm disponible bajo solicitud, con precios y plazo de entrega a concordar / На заказ возможна также толщина в 2,5 мм

DoP



Usage / Utilisation / Benutzung / Uso / Применение

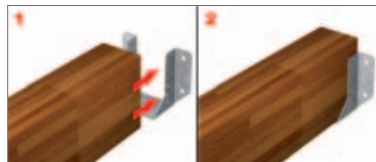

Box / Boîte / Verpackung / Caja / Упаковка



KY 02

Pre-galvanized steel adjustable joist hanger with open wings

- 🇫🇷 Sabot prézingué à deux éléments extérieures réglables
- 🇩🇪 Vorverzinkte Balkenschuhe, zweiteilig, nach außen regulierbar
- 🇪🇸 Par de soportes regulable con alas exteriores para vigas de madera, de acero pregalvanizado
- 🇷🇺 Регулируемая пара опоры бруса открытая, оцинкованная

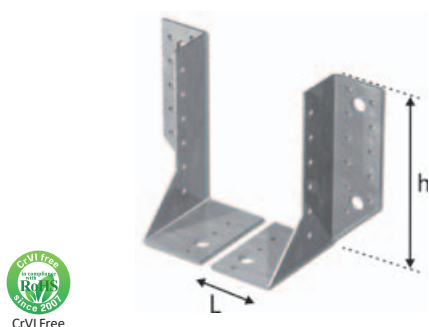

Item code	Size	Thickness* (mm)	Holes diameter (mm)		Pcs. per carton (set)
	L x h (mm)				
KY 02 30 100	30 x 100	2	5	11	24
KY 02 30 130	30 x 130	2	5	11	24
KY 02 40 150	40 x 150	2	5	13	24

* 2,5 mm thickness available on request / Disponible sur demande (prix et délai de livraison à concorder) aussi avec épaisseur 2,5mm mit Dicke 2,5mm (Preise und Liefertermin zu vereinbaren) auf Anfrage / Grosor 2,5 mm disponible bajo solicitud, con precios y plazo de entrega a concordar / На заказ возможна также толщина в 2,5 мм

Usage / Utilisation / Benutzung / Uso / Применение

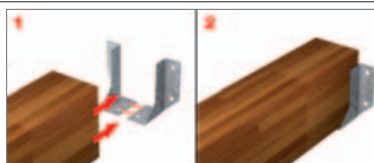

Box / Boîte / Verpackung / Caja / Упаковка



KW 2

Pre-galvanized steel Joist Hanger with Inner Folded Wings

- Sabot prézingué à ailes intérieures
- Vorverzinkte Balkenschuhe, einteilig, nach innen abgewickelt
- Soporte con alas interiores para vigas de madera, de acero pregalvanizado
- Опора бруса закрытая, оцинкованная

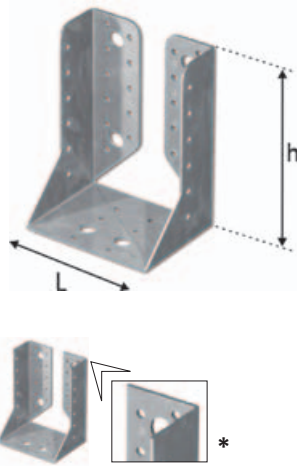

- * Some sizes without rounded edges
- Quelques mesures n'ont pas les angles arrondis
 - Einige Größe haben keine runde Winkel
 - Algunas medidas no tienen ángulos redondeados
 - Для некоторых размеров не предусматриваются закругленные углы



Item code	Size	Thickness* (mm)	Holes diameter (mm)		Pcs. per carton
	L x h (mm)				
KW 20 60 100	60 x 100	2	5	13	24
KW 20 60 160	60 x 160	2	5	13	24
KW 20 80 120	80 x 120	2	5	11	24
KW 20 80 150	80 x 150	2	5	13	24
KW 20 90 115	90 x 115	2	5	11	24
KW 20 90 145	90 x 145	2	5	13	24
KW 21 00 110	100 x 110	2	5	11	24
KW 21 00 140	100 x 140	2	5	13	24
KW 21 20 160	120 x 160	2	5	13	18
KW 21 20 190	120 x 190	2	5	13	18
KW 21 40 180	140 x 180	2	5	13	18

ETA-CE Certified / Certifié ETA-CE / ETA-CE Zulassung / Certificado ETA-CE / Сертификат ETA-CE
 Fire Reaction A1 / Réaction au feu A1 / Brandverhalten A1 / Reacción al fuego A1 / Реакция на огонь A1
 2,5 mm thickness available on request / Disponible sur demande (prix et délai de livraison à concorder) aussi avec épaisseur 2,5mm mit Dicke 2,5mm (Preise und Liefertermin zu vereinbaren) auf Anfrage / Grosor 2,5 mm disponible bajo solicitud, con precios y plazo de entrega a concordar / На заказ возможна также толщина в 2,5 мм

Usage / Utilisation / Benutzung / Uso / Применение



Box / Boîte / Verpackung / Caja / Упаковка



KO 02

Pre-galvanized steel adjustable joist hanger with inner folded wings

- Sabot prézingué à deux éléments intérieures réglables
- Vorverzinkte Balkenschuhe, zweiteilig, nach innen regulierbar
- Par de supports regulable con alas interiores para vigas de madera, de acero pregalvanizado
- Регулируемая пара опоры бруса закрытая, оцинкованная

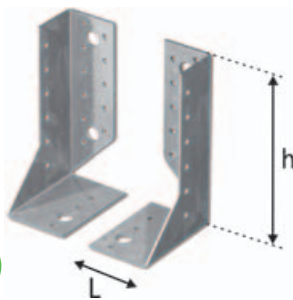

Item code	Size	Thickness* (mm)	Holes diameter (mm)		Pcs. per carton (set)
	L x h (mm)				
KO 02 40 120	40 x 120	2	5	11	24
KO 02 40 150	40 x 150	2	5	13	24

* 2,5 mm thickness available on request / Disponible sur demande (prix et délai de livraison à concorder) aussi avec épaisseur 2,5mm mit Dicke 2,5mm (Preise und Liefertermin zu vereinbaren) auf Anfrage / Grosor 2,5 mm disponible bajo solicitud, con precios y plazo de entrega a concordar / На заказ возможна также толщина в 2,5 мм

Usage / Utilisation / Benutzung / Uso / Применение

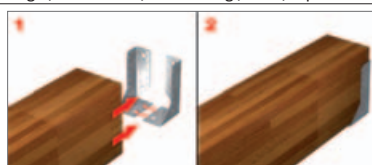





Box / Boîte / Verpackung / Caja / Упаковка









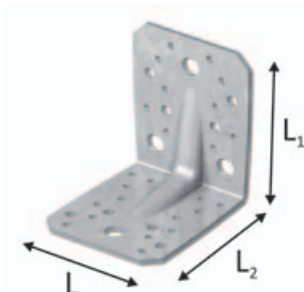





























KS 02

Pre-galvanized steel heavy angled bracket with rib

-  Equerre lourde nervurée, prézinguée
-  Vorverzinkter Schwer- Lochplattenwinkel mit Rippen
-  Escuadra pesada reforzada con nervadura, de acero pregalvanizado
-  Крепежный усиленный уголок, оцинкованный



Item code	Size $L_1 \times L_2 \times L$ (mm)	Thickness (mm)	Holes diameter (mm)			Pcs. per carton
			5	7,5	9	
    KS 02 05 020	50 x 50 x 40	2	5	7,5	9	60
    KS 02 05 025	50 x 50 x 40	2,5	5	7,5	9	60
    KS 02 07 020	70 x 70 x 55	2	5	7,5	11	60
    KS 02 07 025	70 x 70 x 55	2,5	5	7,5	11	60
    KS 02 09 020	90 x 90 x 65	2	5	7,5	11	30
    KS 02 09 025	90 x 90 x 65	2,5	5	7,5	11	30
    KS 02 10 520	105 x 105 x 90	2	5	7,5	13	20
    KS 02 10 525	105 x 105 x 90	2,5	5	7,5	13	20
    KS 02 10 530	105 x 105 x 90	3	5	7,5	13	20

 ETA-CE Certified / Certifié ETA-CE / ETA-CE Zulassung / Certificado ETA-CE / Сертификат ETA-CE

 Fire Reaction A1 / Réaction au feu A1 / Brandverhalten A1 / Reacción al fuego A1 / Реакция на огонь A1



DoP



Usage / Utilisation / Benutzung / Uso / Применение

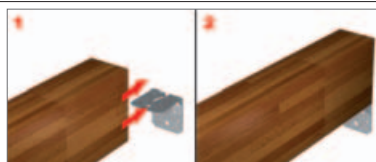





Box / Boîte / Verpackung / Caja / Упаковка











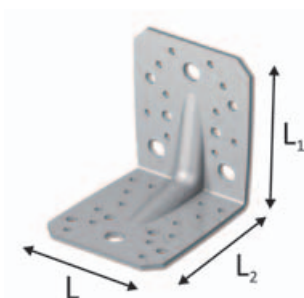
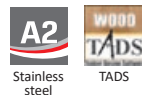







KS 21

INOX
Stainless Steel

A2 stainless steel heavy angled bracket with rib

-  Equerre lourde nervurée, en acier Inox A2
-  Schwer- Lochplattenwinkel mit Rippen aus Edelstahl A2
-  Escuadra pesada reforzada con nervadura, de acero inoxidable A2
-  Крепежный усиленный уголок из нержавеющей стали A2



Item code	Size $L_1 \times L_2 \times L$ (mm)	Thickness (mm)	Holes diameter (mm)			Pcs. per carton
			5	7,5	9	
    KS 21 05 020	50 x 50 x 40	2	5	7,5	9	60
    KS 21 07 020	70 x 70 x 55	2	5	7,5	11	60
    KS 21 09 020	90 x 90 x 65	2	5	7,5	11	30
    KS 21 10 520	105 x 105 x 90	2	5	7,5	13	20

 ETA-CE Certified / Certifié ETA-CE / ETA-CE Zulassung / Certificado ETA-CE / Сертификат ETA-CE

 Fire Reaction A1 / Réaction au feu A1 / Brandverhalten A1 / Reacción al fuego A1 / Реакция на огонь A1



DoP



Usage / Utilisation / Benutzung / Uso / Применение

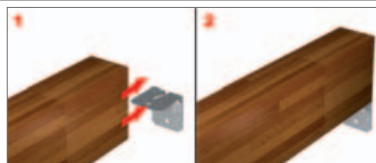

Box / Boîte / Verpackung / Caja / Упаковка



KZ 02

Pre-galvanized steel heavy angled bracket

- 🇫🇷 Equerre lourde prézinguée
- 🇩🇪 Vorverzinkter Schwer- Lochplattenwinkel
- 🇪🇸 Escuadra pesada, de acero pregalvanizado
- 🇷🇺 Крепежный равносторонний уголок, оцинкованный

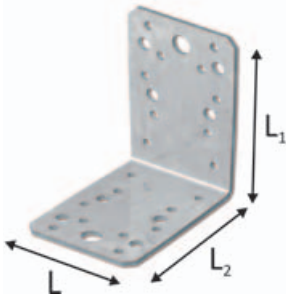

Item code	Size	Thickness (mm)	Holes diameter (mm)			Pcs. per carton
	L ₁ x L ₂ x L (mm)		5	7,5	9	
🔥 KZ 02 05 020	50 x 50 x 40	2	5	7,5	9	60
🔥 KZ 02 05 025	50 x 50 x 40	2,5	5	7,5	9	60
🔥 KZ 02 07 020	70 x 70 x 55	2	5	7,5	11	60
🔥 KZ 02 07 025	70 x 70 x 55	2,5	5	7,5	11	60
🔥 KZ 02 09 020	90 x 90 x 65	2	5	7,5	11	30
🔥 KZ 02 09 025	90 x 90 x 65	2,5	5	7,5	11	30
🔥 KZ 02 10 520	105 x 105 x 90	2	5	7,5	13	20
🔥 KZ 02 10 525	105 x 105 x 90	2,5	5	7,5	13	20
🔥 KZ 02 10 530	105 x 105 x 90	3	5	7,5	13	20

🔥 ETA-CE Certified / Certifié ETA-CE / ETA-CE Zulassung / Certificado ETA-CE / Сертификат ETA-CE

🔥 Fire Reaction A1 / Réaction au feu A1 / Brandverhalten A1 / Reacción al fuego A1 / Реакция на огонь A1



DoP



Usage / Utilisation / Benutzung / Uso / Применение

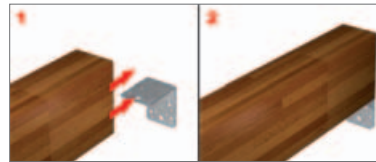

Box / Boîte / Verpackung / Caja / Упаковка



KZ 21

A2 stainless steel heavy angled bracket

- 🇫🇷 Equerre lourde, en acier Inox A2
- 🇩🇪 Schwer- Lochplattenwinkel aus Edelstahl A2
- 🇪🇸 Escuadra pesada, de acero inoxidable A2
- 🇷🇺 Крепежный равносторонний уголок из нержавеющей стали A2

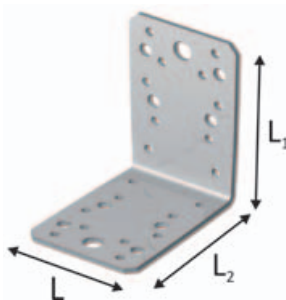

Item code	Size	Thickness (mm)	Holes diameter (mm)			Pcs. per carton
	L ₁ x L ₂ x L (mm)		5	7,5	9	
🔥 KZ 21 05 020	50 x 50 x 40	2	5	7,5	9	60
🔥 KZ 21 07 020	70 x 70 x 55	2	5	7,5	11	60
🔥 KZ 21 09 020	90 x 90 x 65	2	5	7,5	11	30
🔥 KZ 21 10 520	105 x 105 x 90	2	5	7,5	13	20

🔥 ETA-CE Certified / Certifié ETA-CE / ETA-CE Zulassung / Certificado ETA-CE / Сертификат ETA-CE

🔥 Fire Reaction A1 / Réaction au feu A1 / Brandverhalten A1 / Reacción al fuego A1 / Реакция на огонь A1



DoP



Usage / Utilisation / Benutzung / Uso / Применение

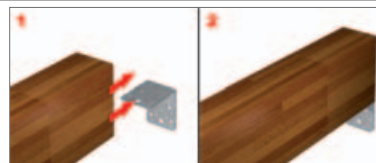





Box / Boîte / Verpackung / Caja / Упаковка



TD 02

Pre-galvanized steel heavy 135° angled bracket

-  Sabot lourd prézingué à angle de 135°
-  Vorverzinkter 135° Schwer- Lochplattenwinkel
-  Escuadra pesada a 135°, de acero pregalvanizado
-  Крепежный уголок под 135°, оцинкованный

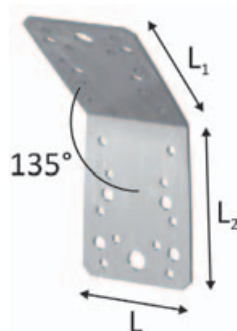

Item code	Size	Thickness (mm)	Holes diameter (mm)			Pcs. per carton
	L ₁ x L ₂ x L (mm)		5	7,5	9	
TD 02 05 020	50 x 50 x 40	2	5	7,5	9	60
TD 02 05 025	50 x 50 x 40	2,5	5	7,5	9	60
TD 02 07 020	70 x 70 x 55	2	5	7,5	11	60
TD 02 07 025	70 x 70 x 55	2,5	5	7,5	11	60
TD 02 09 020	90 x 90 x 65	2	5	7,5	11	30
TD 02 09 025	90 x 90 x 65	2,5	5	7,5	11	30
TD 02 10 520	105 x 105 x 90	2	5	7,5	13	20
TD 02 10 525	105 x 105 x 90	2,5	5	7,5	13	20
TD 02 10 530	105 x 105 x 90	3	5	7,5	13	20

Usage / Utilisation / Benutzung / Uso / Применение

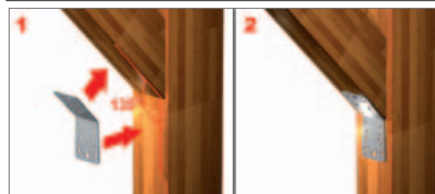





Box / Boîte / Verpackung / Caja / Упаковка



TD 21



A2 stainless steel heavy 135° angled bracket

-  Sabot lourd en acier Inox A2 à angle de 135°
-  135° Schwer- Lochplattenwinkel aus Edelstahl A2
-  Escuadra pesada a 135°, de acero inoxidable A2
-  Крепежный уголок под 135° из нержавеющей стали A2

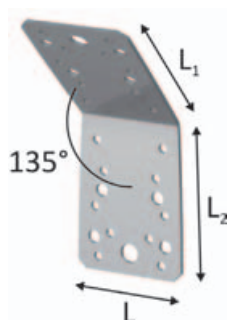

Item code	Size	Thickness (mm)	Holes diameter (mm)			Pcs. per carton
	L ₁ x L ₂ x L (mm)		5	7,5	9	
TD 21 05 020	50 x 50 x 40	2	5	7,5	9	60
TD 21 07 020	70 x 70 x 55	2	5	7,5	11	60
TD 21 09 020	90 x 90 x 65	2	5	7,5	11	30
TD 21 10 520	105 x 105 x 90	2	5	7,5	13	20

Usage / Utilisation / Benutzung / Uso / Применение



Box / Boîte / Verpackung / Caja / Упаковка



TA 2

Pre-galvanized steel rectangular heavy plate with nail and screw holes

- Plaque rectangulaire lourde, prézinguée, perforée pour clous et vis
- Vorverzinkte Schwer- Rechteckige Lochplatte für Nägel und Schrauben
- Pletina rectangular pesada con agujeros para puntas y tornillos, de acero pregalvanizado
- Крепежная пластина, оцинкованная

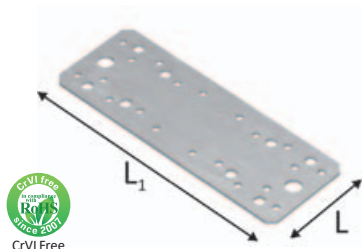

Item code	Size L x L ₁ (mm)	Thickness (mm)	Holes diameter (mm)			Pcs. per carton
			5	7,5	9	
CE TA 24 01 020	40 x 95	2	5	7,5	9	100
CE TA 24 01 025	40 x 95	2,5	5	7,5	9	100
CE TA 25 51 420	55 x 135	2	5	7,5	11	50
CE TA 25 51 425	55 x 135	2,5	5	7,5	11	50
CE TA 26 51 820	65 x 175	2	5	7,5	11	50
CE TA 26 51 825	65 x 175	2,5	5	7,5	11	50
CE TA 29 02 120	90 x 205	2	5	7,5	13	25
CE TA 29 02 125	90 x 205	2,5	5	7,5	13	25
CE TA 29 02 130	90 x 205	3	5	7,5	13	25

CE Certified / Certifié CE / CE Zulassung / Certificado CE / Сертификат CE

Fire Reaction A1 / Réaction au feu A1 / Brandverhalten A1 / Reacción al fuego A1 / Реакция на огонь A1



DoP



Usage / Utilisation / Benutzung / Uso / Применение

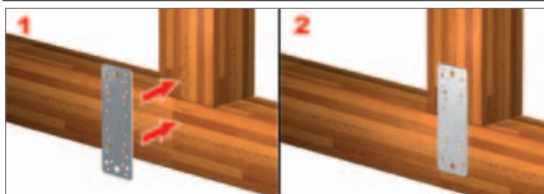

Box / Boîte / Verpackung / Caja / Упаковка



TA 6 **INOX WAVE** Stainless Steel

A2 (AISI 304) stainless steel rectangular heavy plate with nail and screw holes

- Plaque rectangulaire lourde, en acier inox A2 (AISI 304), perforée pour clous et vis
- Schwer-Rechteckige Lochplatte für Nägel und Schrauben, Edstahl A2 (AISI 304)
- Pletina rectangular pesada con agujeros para puntas y tornillos, de acero inoxidable A2 (AISI 304)
- Крепежная пластина, из нержавеющей стали A2 (AISI 304)

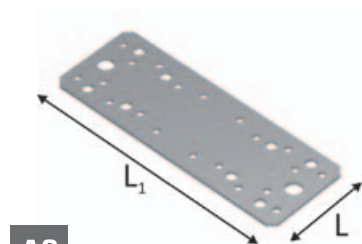

Item code	Size L x L ₁ (mm)	Thickness (mm)	Holes diameter (mm)			Pcs. per carton
			5	7,5	9	
CE TA 64 01 020	40 x 95	2	5	7,5	9	100
CE TA 65 51 420	55 x 135	2	5	7,5	11	50
CE TA 66 51 820	65 x 175	2	5	7,5	11	50
CE TA 69 02 120	90 x 205	2	5	7,5	13	25

CE Certified / Certifié CE / CE Zulassung / Certificado CE / Сертификат CE

Fire Reaction A1 / Réaction au feu A1 / Brandverhalten A1 / Reacción al fuego A1 / Реакция на огонь A1



DoP



Usage / Utilisation / Benutzung / Uso / Применение

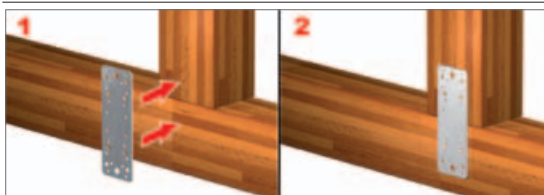

Box / Boîte / Verpackung / Caja / Упаковка



TN 02

🇬🇧 Pregalvanized steel couple of plates (left and right), for lateral wood beam fixing

🇫🇷 Platte prézinguée à deux éléments (droit et gauche), pour fixation latéral de poutre en bois

🇩🇪 Vorverzinkte zweiteilige Lochplatte (links und recht), für Seitenbefestigung von Holzbalken

🇪🇸 Par de soportes (izquierda y derecha), para la fijación lateral de vigas de madera, de acero pregalvanizado

🇷🇺 Пара крепежных оцинкованных пластин (правая и левая) для бокового крепления деревянных брусьев

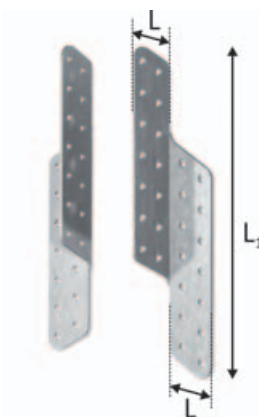

Item code	Size	Thickness* (mm)	Holes diameter (mm)	Pcs. per carton (set)
	L x L ₁ (mm)			
TN 02 17 020	35 x 170	2	5	50
TN 02 17 030	35 x 170	3	5	50
TN 02 21 020	35 x 210	2	5	50
TN 02 21 030	35 x 210	3	5	50

* 2,5 mm thickness available on request / Disponible sur demande (prix et délai de livraison à concorder) aussi avec épaisseur 2,5mm / mit Dicke 2,5mm (Preise und Liefertermin zu vereinbaren) auf Anfrage / Grosor 2,5 mm disponible bajo solicitud, con precios y plazo de entrega a concordar / На заказ возможна также толщина в 2,5 мм

Usage / Utilisation / Benutzung / Uso / Применение

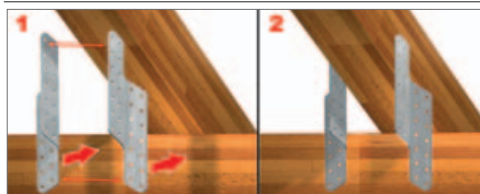

Box / Boîte / Verpackung / Caja / Упаковка



TN 21

INOX WAVE
Stainless Steel

🇬🇧 A2 (AISI 304) stainless steel couple of plates (left and right), for lateral wood beam fixing

🇫🇷 Platte en acier inox A2 (AISI 304) à deux éléments (droit et gauche), pour fixation latéral de poutre en bois

🇩🇪 Zweiteilige Lochplatte (links und recht) aus Edelstahl A2 (AISI 304), für Seitenbefestigung von Holzbalken

🇪🇸 Par de soportes (izquierda y derecha), para la fijación lateral de vigas de madera, de acero Inoxidable A2 (AISI 304)

🇷🇺 Пара крепежных пластин (правая и левая) из нержавеющей стали A2 (AISI 304) для бокового крепления деревянных брусьев

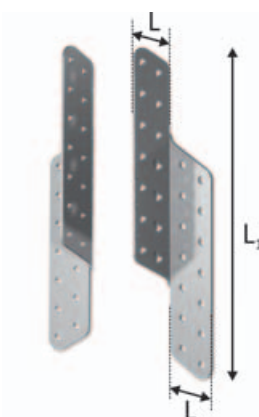

Item code	Size	Thickness (mm)	Holes diameter (mm)	Pcs. per carton (set)
	L x L ₁ (mm)			
TN 21 17 020	35 x 170	2	5	50
TN 21 21 020	35 x 210	2	5	50

Usage / Utilisation / Benutzung / Uso / Применение

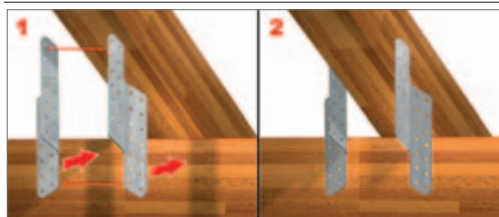

Box / Boîte / Verpackung / Caja / Упаковка



KJ 1

“U” shaped wood beam bracket, zinc plated

- Equerre en forme de “U”, zinguée
- U-förmiger Lochplattenwinkel, verzinkt
- Soporte en “U” para vigas de madera, de acero cincado
- Оцинкованный Кронштейн “U” для крепления наклонных балок

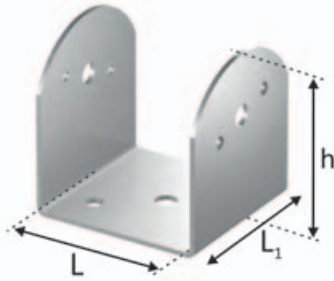

Item code	Size L x L1 x h (mm)	Thickness (mm)	Holes diameter		Pcs. per carton
			base (mm)	wings (mm)	
KJ 13 00 451	45 x 80 x 40	3	6,5 (2 holes)		20
KJ 13 00 601	60 x 60 x 85	3	9 (2 holes) - 13 (1 hole)		20
KJ 13 00 701	70 x 70 x 80	3	8 (2 holes)		15
KJ 13 00 801	80 x 80 x 85	3	9 (2 holes) - 13 (1 hole)		10
KJ 13 00 901	90 x 90 x 90	3	9 (2 holes)		10
KJ 13 01 001	100 x 100 x 105	3	9 (2 holes) - 13 (1 hole)		8
KJ 13 01 201	120 x 120 x 125	3	9 (2 holes) - 13 (1 hole)		8
KJ 14 01 401	140 x 140 x 160	4	11 (4 holes)		4

Usage / Utilisation / Benutzung / Uso / Применение

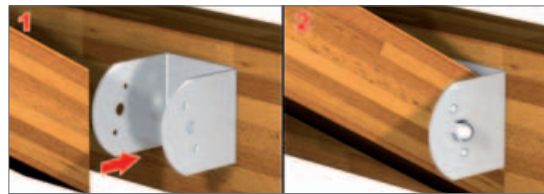

Box / Boîte / Verpackung / Caja / Упаковка



TE 02

Pre-galvanized steel T-plate with nail and screw holes

- Platte prézinguée en forme de T, perforée pour clous et vis
- Vorverzinkt T-förmige Lochplatte für Nägel und Schrauben
- Pletina en “T” con agujeros para puntas y tornillos, de acero pregalvanizado
- Крепежный уголок типа “Т”, оцинкованный

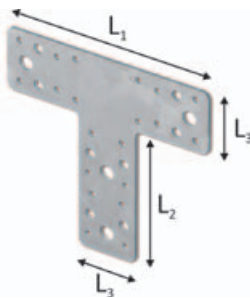

Item code	Size L1 x L2 x L3 (mm)	Thickness (mm)	Holes diameter (mm)			Pcs. per carton
			5	7,5	11	
CE TE 02 08 020	80 x 68 x 38	2	5	7,5	11	50
CE TE 02 08 025	80 x 68 x 38	2,5	5	7,5	11	50
TE 02 16 020	160 x 98 x 45	2	5	7,5	11	25
TE 02 16 025	160 x 98 x 45	2,5	5	7,5	11	25

CE Certified / Certifié CE / CE Zulassung / Certificado CE / Сертификат CE

Fire Reaction A1 / Réaction au feu A1 / Brandverhalten A1 / Reacción al fuego A1 / Реакция на огонь A1

Until stockout / Jusqu'à épuisement de stocks / Solange der Vorrat reicht / Hasta agotar existencias / до окончания стока

Usage / Utilisation / Benutzung / Uso / Применение

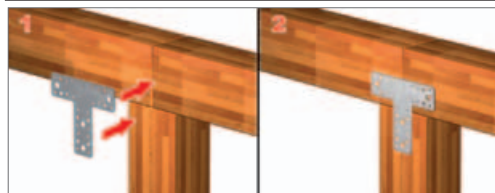

Box / Boîte / Verpackung / Caja / Упаковка



DoP



TB 2

Pre-galvanized steel rectangular heavy plate with nail holes

- 🇫🇷 Plaque rectangulaire lourde, prézinguée, perforée pour clous
- 🇩🇪 Schwere vorverzinkte- Rechteckige Lochplatte
- 🇪🇸 Pletina rectangular pesada con agujeros para puntas, de acero pregalvanizado
- 🇷🇺 Соединительная пластина, оцинкованная

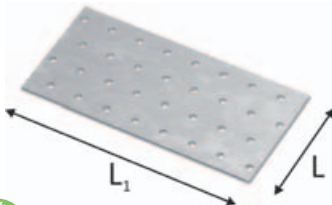

CrVI Free

Very long sizes (even over 1 meter) available on request / Longueur spéciales (plus d'un mètre) disponible sur demande / Besondere Länge (auch über 1 Meter) / MEDIDAS ESPECIALES (también más que 1 metro) - disponibles bajo solicitud / Особо большие размеры (и более 1 м) - на заказ



DoP



Usage / Utilisation / Benutzung / Uso / Применение

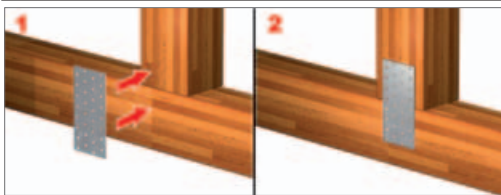

Item code	Size	Thickness (mm)	Holes diameter (mm)	Pcs. per carton
	L x L ₁ (mm)			
CE TB 20 40 080	40 x 80	2	5	100
CE TB 20 40 120	40 x 120	2	5	100
CE TB 20 40 160	40 x 160	2	5	50
CE TB 20 40 200	40 x 200	2	5	50
CE TB 20 60 040	60 x 40	2	5	100
CE TB 20 60 080	60 x 80	2	5	100
CE TB 20 60 120	60 x 120	2	5	100
CE TB 20 60 160	60 x 160	2	5	50
CE TB 20 60 200	60 x 200	2	5	50
CE TB 20 60 240	60 x 240	2	5	25
CE TB 20 80 040	80 x 40	2	5	100
CE TB 20 80 080	80 x 80	2	5	100
CE TB 20 80 120	80 x 120	2	5	50
CE TB 20 80 160	80 x 160	2	5	50
CE TB 20 80 200	80 x 200	2	5	50
CE TB 20 80 240	80 x 240	2	5	25
CE TB 20 80 280	80 x 280	2	5	25
CE TB 20 80 320	80 x 320	2	5	25
CE TB 21 00 040	100 x 40	2	5	100
CE TB 21 00 080	100 x 80	2	5	50
CE TB 21 00 120	100 x 120	2	5	50
CE TB 21 00 160	100 x 160	2	5	50
CE TB 21 00 200	100 x 200	2	5	50
CE TB 21 00 240	100 x 240	2	5	25
CE TB 21 00 280	100 x 280	2	5	25
CE TB 21 00 320	100 x 320	2	5	25

CE Certified / Certifié CE / CE Zulassung / Certificado CE / Сертификат CE

Fire Reaction A1 / Réaction au feu A1 / Brandverhalten A1 / Reacción al fuego A1 / Реакция на огонь A1

TBR

Pre-galvanized steel band, 25 mt length, with nail holes

- 🇫🇷 Bande à clouer en acier pré-galvanisé, longueur 25 mt, avec trous pour clous
- 🇩🇪 Band aus verzinktem Stahl, 25 m Länge mit Bohrungen für Nägel
- 🇪🇸 Cinta perforada de acero pregalvanizado, longitud 25 mt
- 🇷🇺 Оцинкованная стальная лента, длина 25м, с отверстиями для гвоздей

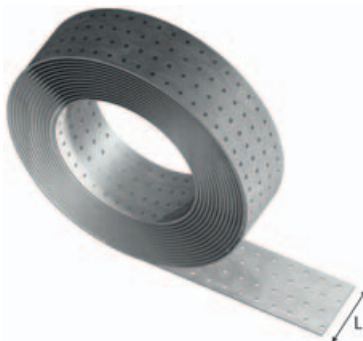

CrVI Free



DoP



Item code	Size	Thickness (mm)	Holes diameter (mm)	Pcs. per carton
	L (mm)			
CE TB 20 40 250	40	2	5	1
CE TB 20 60 250	60	2	5	1
CE TB 20 80 250	80	2	5	1

CE Certified / Certifié CE / CE Zulassung / Certificado CE / Сертификат CE

Fire Reaction A1 / Réaction au feu A1 / Brandverhalten A1 / Reacción al fuego A1 / Реакция на огонь A1

Usage / Utilisation / Benutzung / Uso / Применение

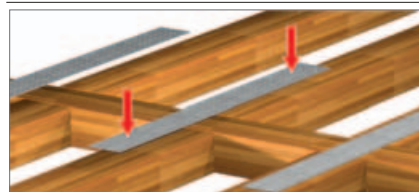

Box / Boîte / Verpackung / Caja / Упаковка

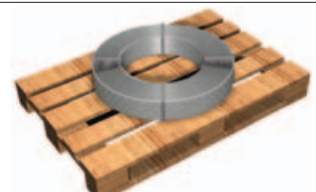

QBS 31 ^{NEW}

EN 912-C2 type - Single-sided tooth plate wood connector with flanged bolt-hole, hot dip galvanized

- EN 912-C2 - Connecteur denté à bois simple face avec trou central à bride, galvanisé à chaud
- EN 912-C2 - Scheibendübel einseitig mit Zähnen mit gebördeltem Mittelloch, vorverzinkter Stahl
- EN 912 Tipo C2 - Conector para madera dentado de una cara, de acero galvanizado en caliente
- EN 912 Тип C2 - Односторонний зубчатый соединитель по дереву с фланцевым центральным отверстием из горячеоцинкованной стали



DoP



Item code	Size	Thickness	Nail holes	Pcs. per box	Pcs. per carton
	D x d (mm)	(mm)	Ø (mm)		
CE QBS 31 12 050	50 x 12,4	1	4	200	1.000
CE QBS 31 12 062	62 x 12,4	1,2	4	100	500

CE Certified / Certifié CE / CE Zulassung / Certificado CE / Сертификат CE

Fire Reaction A1 / Réaction au feu A1 / Brandverhalten A1 / Reacción al fuego A1 / Реакция на огонь A1

On request, Ø50 is also available with hole: Ø10,4 - Ø16,4 - Ø20,4, CE certified

On request, Ø62 is also available with hole: Ø16,4 - Ø20,4, CE certified

On request, also available in pre-galvanized steel (item code: QBS 11), not covered by EN 912 (and not CE certified) / Disponible, sur demande, en acier prézingué (code: QBS 11), pas prévu par le EN912 (et pas certifié ETA-CE) / Auf Anfrage erhältlich, in vorverzinntem Stahl (Code: QBS 11), nicht vorgesehen von EN 912 (und nicht CE-zertifiziert) / Disponible a solicitud de acero pregalvanizado (código: QBS 11), no incluido en la EN 912 (y no homologado CE) / Доступно по запросу из предварительно оцинкованной стали (код: QBS 11), не подпадает под действие EN 912. (и не сертифицирован CE)

Description / Description / Beschreibung / Descripción / Описание

The single-sided tooth plate wood connector with flanged bolt-hole, hot dip galvanized, CE certified according to EN 912 (Type C2), is suitable for joining steel-wood or wood-wood parts with nails, screws and bolts, avoiding relative sliding.

Usage / Utilisation / Benutzung / Uso / Применение



Box / Boîte / Verpackung / Caja / Упаковка



QBD 31 ^{NEW}

EN 912-C1 type - Double-sided tooth plate wood connector with flat bolt-hole, hot dip galvanized

- EN 912-C1 - Connecteur denté à bois double face avec trou central à bride, galvanisé à chaud
- EN 912-C1 Typ - Scheibendübel zweiseitig mit Zähnen mit flachem Mittelloch, vorverzinkter Stahl
- EN 912 Tipo C1 - Conector para madera dentado de doble cara, de acero galvanizado en caliente
- EN 912 Тип C1 - Соединитель по дереву с двусторонней зубчатой пластиной и плоским центральным отверстием из горячеоцинкованной стали



DoP



Item code	Size	Thickness	Nail holes	Pcs. per box	Pcs. per carton
	D x d (mm)	(mm)	Ø (mm)		
CE QBD 31 17 050	50 x 17	1	4	150	750
CE QBD 31 21 062	62 x 21	1,2	4	75	375

CE Certified / Certifié CE / CE Zulassung / Certificado CE / Сертификат CE

Fire Reaction A1 / Réaction au feu A1 / Brandverhalten A1 / Reacción al fuego A1 / Реакция на огонь A1

On request, also available in pre-galvanized steel (item code: QBD 11), CE certified / Disponible, sur demande, en acier prézingué (code: QBD 11), certifié ETA-CE / Auf Anfrage erhältlich, in vorverzinntem Stahl (Code: QBD 11), nicht vorgesehen von EN 912 (und nicht CE-zertifiziert) / Disponible a solicitud de acero pregalvanizado (código: QBD 11), Homologado CE / По запросу также доступны из предварительно оцинкованной стали (код изделия: QBD 11), сертифицированы CE

Description / Description / Beschreibung / Descripción / Описание

The double-sided tooth plate wood connector with flat bolt-hole, hot dip galvanized, CE certified according to EN 912 (Type C1), is suitable for joining wood-wood parts with nails, screws and bolts, avoiding relative sliding.

Usage / Utilisation / Benutzung / Uso / Применение

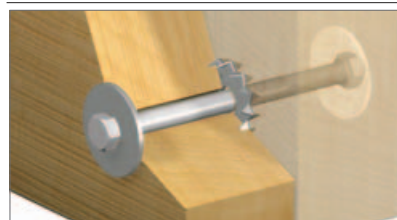





Box / Boîte / Verpackung / Caja / Упаковка



MN - MO

Pre-galvanized steel heavy angled bracket with ribs

-  Equerre lourde nervurée, prézinguée
-  Vorverzinkter Schwer- Lochplattenwinkel mit Rippen
-  Escuadra pesada reforzada con nervaduras, de acero pregalvanizado
-  Крепежный усиленный уголок, оцинкованный

MN 02 with 6 countersunk holes / avec 6 trous fraisés / mit 6 Senklöcher / con 6 agujeros avellanados / с 6 плоскими отверстиями



Item code	Size $L_1 \times L_2 \times L$ (mm)	Thickness (mm)	Holes diameter (mm)	Pcs. per carton	Pcs. per carton
MN 02 04 825	48 x 48 x 40	2,5	4	100	500



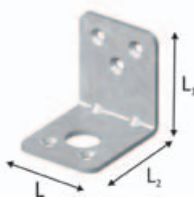

MO 02 with 5 countersunk holes and 1 large hole diam. 16 / avec 5 trous fraisés et 1 trou large diam. 16 / mit 5 Senklöcher und 1 breitem Loch Durchm. 16 / con 5 agujeros avellanados y un agujero diam. 16 / с 5 плоскими отверстиями и большим отверстием диаметром 16 мм



Item code	Size $L_1 \times L_2 \times L$ (mm)	Thickness (mm)	Holes diameter (mm)		Pcs. per box	Pcs. per carton
MO 02 04 825	48 x 48 x 40	2,5	4	16	100	500

MP - MQ

Pre-galvanized steel heavy angled bracket with ribs

-  Equerre lourde nervurée, prézinguée
-  Vorverzinkter Schwer- Lochplattenwinkel mit Rippen
-  Escuadra pesada reforzada con nervaduras, de acero pregalvanizado
-  Крепежный усиленный уголок, оцинкованный

MP 27 with 6 countersunk holes / avec 6 trous fraisés / mit 6 Senklöcher / con 6 agujeros avellanados / с 6 плоскими отверстиями

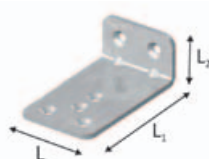

Item code	Size $L_1 \times L_2 \times L$ (mm)	Thickness (mm)	Holes diameter (mm)	Pcs. per box	Pcs. per carton
MP 27 02 525	70 x 25 x 40	2,5	4	100	500



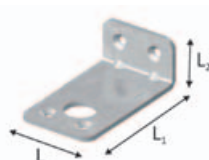

MQ 27 with 4 countersunk holes and 1 large hole diam. 16 / avec 4 trous fraisés et 1 trou large diam. 16 / mit 4 Senklöcher und 1 breitem Loch Durchm. 16 / con 4 agujeros avellanados y un agujero diam. 16 / с 4 плоскими отверстиями и большим отверстием диаметром 16 мм



Item code	Size $L_1 \times L_2 \times L$ (mm)	Thickness (mm)	Holes diameter (mm)		Pcs. per box	Pcs. per carton
MQ 27 02 525	70 x 25 x 40	2,5	4	16	100	500

MS - MT

Pre-galvanized steel rectangular heavy plate

-  Plaque rectangulaire lourde, prézinguée
-  Vorverzinkte Schwer- Rechteckige Lochplatte
-  Pletina rectangular pesada, de acero pregalvanizado
-  Крепежная усиленная пластина, оцинкованная

MS 02 with 6 countersunk holes / avec 6 trous fraisés / mit 6 Senklöcher / con 6 agujeros avellanados / с 6 плоскими отверстиями

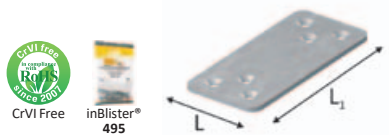

Item code	Size	Thickness (mm)	Holes diameter (mm)		Pcs. per box	Pcs. per carton
	L x L ₁ (mm)		4	16		
 MS 02 09 025	40 x 90	2,5	4	16	100	500



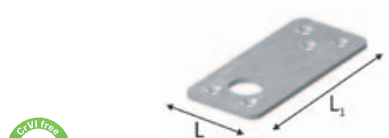

MT 02 with 5 countersunk holes and 1 large hole diam. 16 / avec 5 trous fraisés et 1 trou large diam. 16 / mit 5 Senklöcher und 1 breitem Loch Durchm. 16 / con 5 agujeros avellanados y un agujero diam. 16 / с 5 плоскими отверстиями и большим отверстием диаметром 16 мм







Item code	Size	Thickness (mm)	Holes diameter (mm)		Pcs. per box	Pcs. per carton
	L x L ₁ (mm)		4	16		
 MT 02 09 025	40 x 90	2,5	4	16	100	500

NN

Steel heavy angled bracket with ribs, with 2 small countersunk holes on the long side and 1 small hole in the middle of the short side





-  Equerre lourde nervurée
-  Vorverzinkter Schwer- Lochplattenwinkel mit Rippen
-  Escuadra pesada reforzada con nervaduras
-  Оцинкованный Кронштейн "L" усиленный с ребрами





Item code	Finishing	Size	Thickness (mm)	Holes diameter (mm)		Pcs. per box	Pcs. per carton
		L ₁ x L ₂ x L (mm)		on L ₂ (countersunk)	su L ₁		
 NN 01 00 020	Zinc Plated	22 x 28 x 21	2	4,5 (2 holes)	6 (1 holes)	100	1.000
 NN 05 00 020	Brass	22 x 28 x 21	2	4,5 (2 holes)	6 (1 holes)	100	1.000
 NN 06 00 020	Nickel	22 x 28 x 21	2	4,5 (2 holes)	6 (1 holes)	100	1.000
 NN 07 00 020	Antique brass (bronze)	22 x 28 x 21	2	4,5 (2 holes)	6 (1 holes)	100	1.000

MU 02

Pre-galvanized steel rectangular heavy plate with 6 countersunk rounded holes

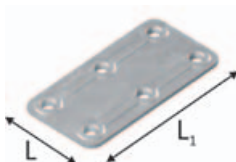



-  Plaque rectangulaire lourde, prézinguée, avec 6 trous fraisés ronds
-  Vorverzinkte Schwer- Rechteckige Lochplatte mit 6 Rund- Senklöcher
-  Pletina rectangular pesada con 6 agujeros avellanados redondeados, de acero pregalvanizado
-  Крепежная усиленная пластина с 6 плоскими скругленными отверстиями, оцинкованная



Item code	Size <i>L x L₁ (mm)</i>	Thickness <i>(mm)</i>	Holes diameter <i>(mm)</i>	Pcs. per box	Pcs. per carton
 MU 02 07 010	35 x 70	1	4	100	500
 MU 02 07 015	35 x 70	1,5	4	100	500

MV 02

Pre-galvanized steel "Z" shaped bracket with 3 holes



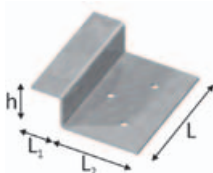

-  Equerre prézinguée en form de Z avec 3 trous
-  Vorverzinkt Z-förmiger Lochplattenwinkel mit 3 Löcher
-  Escuadra en "Z" con 3 agujeros, de acero pregalvanizado
-  Крепежный Z-образный уголок с 3 отверстиями, оцинкованный



Item code	Size <i>L x L₁ x L₂ x h (mm)</i>	Thickness <i>(mm)</i>	Holes diameter <i>(mm)</i>	Pcs. per box	Pcs. per carton
MV 02 06 018	60 x 18 x 40 x 15	1	4	100	1.000

MW 02

Pre-galvanized steel angled bracket with 2 countersunk holes



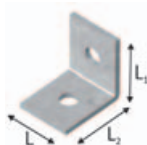

-  Equerre prézinguée avec 2 trous fraisés
-  Vorverzinkter Schwer- Lochplattenwinkel mit 2 Senklöcher
-  Escuadra con 2 agujeros avellanados, de acero pregalvanizado
-  Крепежный уголок с 2 плоскими отверстиями, оцинкованный



Item code	Size <i>L₁ x L₂ x L (mm)</i>	Thickness <i>(mm)</i>	Holes diameter <i>(mm)</i>	Pcs. per box	Pcs. per carton
MW 02 02 520	25 x 25 x 20	2	6,5	100	1.000

NE 2

Pre-galvanized rectangular plate with 4 teeth and central hole

-  Plaque prézinguée dentelée avec trou
-  Vorverzinkt gezähnte Lochplatte
-  Pletina fijapaneles con dientes y agujero central, de acero pregalvanizado
-  Прямоугольная пластина с 4 зубцами и центральным отверстием, оцинкованная

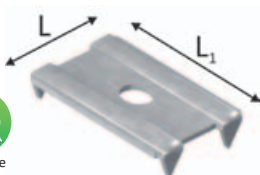

Item code	Size <i>L₁ x L (mm)</i>	Thickness <i>(mm)</i>	Holes diameter <i>(mm)</i>	Pcs. per box	Pcs. per carton
NE 21 62 308	23 x 16	0,8	4,5	500	5.000

NA 02

Pre-galvanized steel angled bracket with rib and countersunk holes

- Equerre lourde nervurée avec trous fraisés
- Vorverzinkter Schwer- Lochplattenwinkel mit Rippen und Senklöcher
- Escuadra reforzada con nervadura, con agujeros avellanados, de acero pregalvanizado
- Крепежный усиленный уголок с плоскими отверстиями, оцинкованный

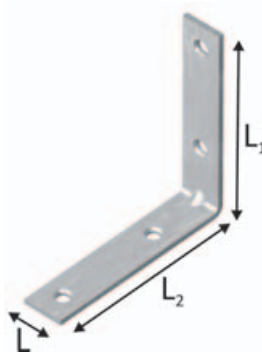

Item code	Size $L_1 \times L_2 \times L$ (mm)	Thickness (mm)	Holes diameter (mm)	Pcs. per box	Pcs. per carton
NA 02 02 020	20 x 20 x 15	2	4,5	100	1000
NA 02 03 020	30 x 30 x 15	2	4,5	100	1000
NA 02 04 020	40 x 40 x 15	2	4,5	100	500
NA 02 05 020	50 x 50 x 15	2	4,5	100	500
NA 02 06 020	60 x 60 x 15	2	4,5	100	500
NA 02 07 020	70 x 70 x 15	2	4,5	-	100
NA 02 08 020	80 x 80 x 15	2	4,5	-	100
NA 02 09 020	90 x 90 x 15	2	4,5	-	100
NA 02 10 020	100 x 100 x 15	2	4,5	-	100

NC 2

Pre-galvanized steel rectangular plate with countersunk holes

- Plaque rectangulaire prézinguée, avec trous fraisés
- Vorverzinkt rechteckige Lochplatte mit Senklöcher
- Pletina rectangular con agujeros avellanados, de acero pregalvanizado
- Крепежная прямоугольная пластина с плоскими отверстиями, оцинкованная

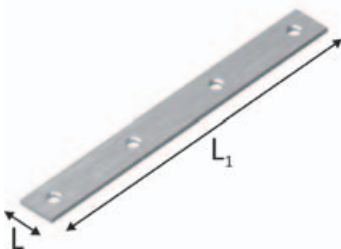

Item code	Size $L_1 \times L$ (mm)	Thickness (mm)	Holes diameter (mm)	Pcs. per carton
NC 21 50 420	40 x 15	2	4,5	100
NC 21 50 620	60 x 15	2	4,5	100
NC 21 50 820	80 x 15	2	4,5	100
NC 21 51 020	100 x 15	2	4,5	100
NC 21 51 220	120 x 15	2	4,5	100
NC 21 51 420	140 x 15	2	4,5	100
NC 21 51 620	160 x 15	2	4,5	100
NC 21 51 820	180 x 15	2	4,5	100
NC 21 52 020	200 x 15	2	4,5	100

MZ 02

Pre-galvanized steel plate with 4 csk holes and sharp edges

- Plaque carrée prézinguée avec 4 trous fraisés, pour le montage des meubles
- Vorverzinkt viereckige Lochplatte mit 4 Senklöcher, für Möbelmontage
- Pletina cuadrada para ensamblaje de muebles, con 4 agujeros avellanados, de acero pregalvanizado
- Крепежная квадратная пластина для сборки мебели с 4 плоскими отверстиями, оцинкованная

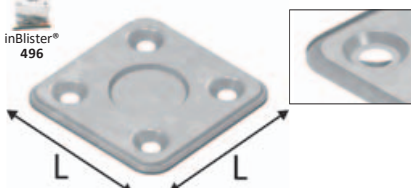

Item code	Size $L \times L$ (mm)	Thickness (mm)	Holes diameter (mm)	Pcs. per box	Pcs. per carton
MZ 02 04 308	43 x 43	0,8	4,5	100	1.000

TG 2

🇬🇧 Squared Post holder, Hot Dip Galvanized

- 🇫🇷 Pied de poteau à boulonner, galvanisé à chaud
- 🇩🇪 Aufschraubbodenhülse für Kanthölzer, feuerverzinkt
- 🇪🇸 Soporte para anclar vigas de madera al suelo, de acero galvanizado en caliente
- 🇷🇺 Квадратное основание колонны, оцинкованное

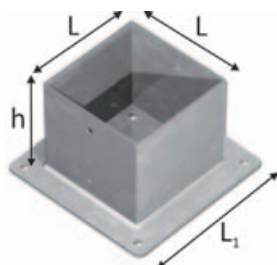

Item code	Size <i>L x L x h x L₁ (mm)</i>	Thickness (mm)		Holes diameter (mm)		Pcs. per carton
		sides	base	on sides	on base	
TG 20 71 150	71 x 71 x 150 x 150	2,5	2,5	11	13	12
TG 20 91 150	91 x 91 x 150 x 170	2,5	2,5	11	13	8
TG 21 01 150	101 x 101 x 150 x 180	2,5	2,5	11	13	8
TG 21 21 150	121 x 121 x 150 x 200	3	3	11	13	6
TG 21 41 150	141 x 141 x 150 x 220	3	3	11	13	4
TG 21 61 150	161 x 161 x 150 x 240	3	4	11	13	4
TG 22 01 200	201 x 201 x 200 x 280	3	4	11	13	4
New item TG 22 41 200	241 x 241 x 200 x 320	3	4	11	13	2

Usage / Utilisation / Benutzung / Uso / Применение

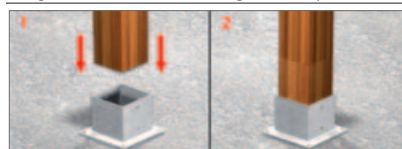

Box / Boîte / Verpackung / Caja / Упаковка



MK 2

🇬🇧 Squared post holder couple, hot dip galvanized

- 🇫🇷 Pied de poteau à boulonner à deux éléments, galvanisé à chaud
- 🇩🇪 Aufschraubbodenhülse zweiteilig, für Kanthölzer, feuerverzinkt
- 🇪🇸 Par de soportes para anclar vigas de madera al suelo, de acero galvanizado en caliente
- 🇷🇺 Регулируемая пара квадратных оснований колонны, оцинкованная

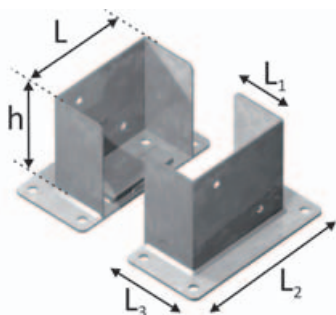

Item code	Size <i>L x L₁ x L₂ x L₃ x h (mm)</i>	Thickness (mm)		Holes diameter (mm)		Pcs. per carton (set)
		sides	base	on sides	on base	
MK 21 21 150	121 x 60 x 200 x 100 x 150	3	3	11	13	6
MK 21 41 150	141 x 70 x 220 x 110 x 150	3	3	11	13	4
MK 21 61 150	161 x 80 x 240 x 120 x 150	3	4	11	13	4
MK 21 81 200	181 x 90 x 260 x 130 x 200	3	4	11	13	4
MK 22 01 200	201 x 100 x 280 x 140 x 200	3	4	11	13	4

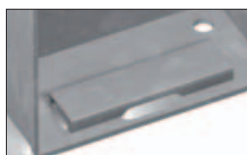

Usage / Utilisation / Benutzung / Uso / Применение



Box / Boîte / Verpackung / Caja / Упаковка



TV 2

🇬🇧 Squared Post holder couple for corners, Hot Dip Galvanized

- 🇫🇷 Pied de poteau à boulonner à deux éléments pour angles, galvanisé à chaud
- 🇩🇪 Aufschraubbodenhülse zweiteilig, für Kanthölzer, feuerverzinkt
- 🇪🇸 Par de soportes para anclar vigas de madera al suelo, de acero galvanizado en caliente
- 🇷🇺 Регулируемая пара квадратного основания колонны, оцинкованная

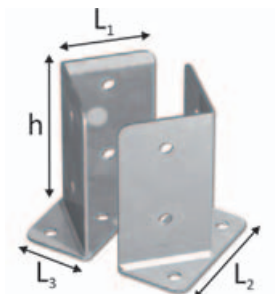

Item code	Size <i>L x L x h x L₁ (mm)</i>	Thickness (mm)		Holes diameter (mm)		Pcs. per carton <i>(set)</i>
		sides	base	on sides	on base	
TV 20 80 150	80 x 150 x 120 x 65	3	3	11	13	10
TV 21 05 200	105 x 200 x 155 x 83	3	3	11	13	8

Usage / Utilisation / Benutzung / Uso / Применение



TR 2

🇬🇧 Round Post holder, Hot Dip Galvanized

- 🇫🇷 Pied de poteau rond à boulonner, galvanisé à chaud
- 🇩🇪 Aufschraubbodenhülse für Rundholzpfosten, feuerverzinkt
- 🇪🇸 Soporte para anclar vigas redondas de madera al suelo, de acero galvanizado en caliente
- 🇷🇺 Круглое основание колонны, оцинкованное

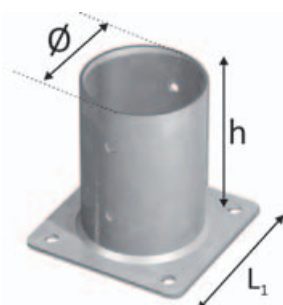

Item code	Size <i>Ø x h x L₁ (mm)</i>	Thickness (mm)		Holes diameter (mm)		Pcs. per carton
		cylinder	base	on sides	on base	
TR 20 80 150	80 x 150 x 150	2,5	2,5	11	13	20
TR 21 00 150	100 x 150 x 150	3	3	11	13	9
TR 21 20 150	120 x 150 x 180	3	3	11	13	7

Usage / Utilisation / Benutzung / Uso / Применение

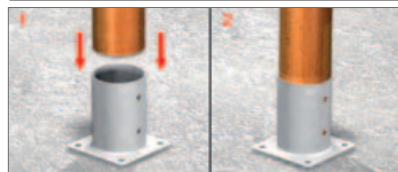

TU 01

U-shaped post holder, hot dip galvanized

🇫🇷 Pied de poteau en forme de U, galvanisé à chaud

🇩🇪 U-förmige Aufschraubbodenhülse, feuerverzinkt

🇪🇸 Soporte en "U" para anclar vigas de madera al suelo de acero galvanizado en caliente

🇷🇺 U-образное основание колонны, оцинкованное

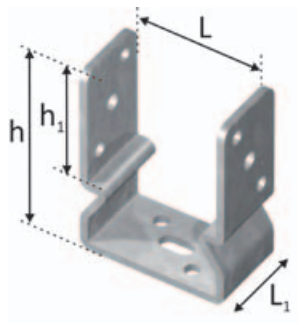

Item code	Size	Thickness (mm)	Holes diameter (mm)		Pcs. per carton	
	$L \times L_1 \times h \times h_1$ (mm)			loop		
TU 01 60 071	71 x 60 x 150 x 95	6	11	13	13 x 26	20
TU 01 60 081	81 x 60 x 150 x 95	6	11	13	13 x 26	20
TU 01 60 091	91 x 60 x 150 x 95	6	11	13	13 x 26	20
TU 01 60 101	101 x 60 x 150 x 95	6	11	13	13 x 26	16
TU 01 60 121	121 x 60 x 150 x 95	6	11	13	13 x 26	16

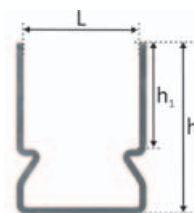

Usage / Utilisation / Benutzung / Uso / Применение

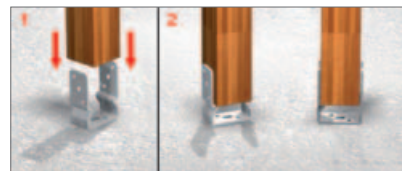

TP 2

Pyramidal Squared Post holder, Hot Dip Galvanized

- 🇫🇷 Pied de poteau à enforcer, galvanisé à chaud
- 🇩🇪 Einschlagbodenhülse für Kanthölzer, feuerverzinkt
- 🇪🇸 Soporte piramidal para anclar vigas de madera al suelo, de acero galvanizado en caliente
- 🇷🇺 Квадратный забивной крепеж для стоек, оцинкованный



Item code	Size	Thickness (mm)	Holes diameter (mm)	Pcs. per carton
	$L \times L \times h \times L_1$ (mm)			
TP 20 71 750	71 x 71 x 150 x 750	2	11	1
TP 20 71 900	71 x 71 x 150 x 900	2	11	1
TP 20 91 750	91 x 91 x 150 x 750	2	11	1
TP 20 91 900	91 x 91 x 150 x 900	2	11	1
TP 21 01 900	101 x 101 x 150 x 900	2,5	11	1

Usage / Utilisation / Benutzung / Uso / Применение

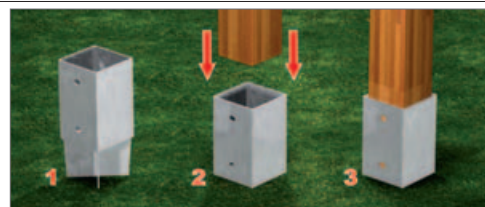

TQ 2

Pyramidal Round Post holder, Hot Dip Galvanized

- 🇫🇷 Pied de poteau rond à enforcer, galvanisé à chaud
- 🇩🇪 Einschlagbodenhülse für Rundholzpfosten, feuerverzinkt
- 🇪🇸 Soporte piramidal para anclar vigas redondas de madera al suelo, de acero galvanizado en caliente
- 🇷🇺 Круглый забивной крепеж для стоек, оцинкованный





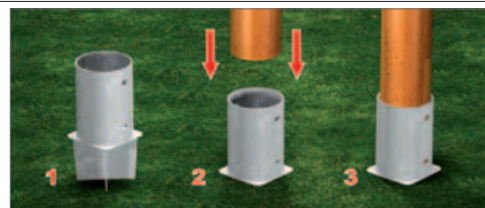

Item code	Size	Thickness (mm)	Holes diameter (mm)	Pcs. per carton
	$\varnothing \times h \times L_1$ (mm)			
TQ 20 80 900	80 x 150 x 900	2	11	1
TQ 21 00 900	100 x 150 x 900	2	11	1
TQ 21 20 900	120 x 150 x 900	2,5	11	1

Usage / Utilisation / Benutzung / Uso / Применение



NH 08 00 001

Six floor wooden display "Expowood", with wooden beam connection kit

-  Présentoir en bois avec 6 étagères "Expowood" avec assortiment de connexions pour le bois
-  Holz- Verkaufsständer mit 6 Ebenen "Expowood", mit Sortiment von Holz- und Balkenverbindungen
-  Expositor de madera "Expowood" completo de surtido de conectores y soportes para vigas de madera
-  Деревянный дисплей с 6 полками "Expowood" в комплекте с полным ассортиментом соединений и опор для клеенного бруса



Kit code	Dimensions	Pcs. per carton
	L x P x h (cm)	
NH 08 00 001	65 x 61 x 186	1





Item code	Description	Pcs. per carton
KS 02 05 020	Pre-galvanized steel heavy angled bracket with rib	60
KS 02 07 020	Pre-galvanized steel heavy angled bracket with rib	60
KS 02 09 020	Pre-galvanized steel heavy angled bracket with rib	60
KS 02 10 525	Pre-galvanized steel heavy angled bracket with rib	40
KZ 02 05 020	Pre-galvanized steel heavy angled bracket	60
KZ 02 07 020	Pre-galvanized steel heavy angled bracket	60
KZ 02 09 020	Pre-galvanized steel heavy angled bracket	60
KZ 02 10 525	Pre-galvanized steel heavy angled bracket	40
TD 02 05 020	Pre-galvanized steel heavy 135° angled bracket	60
TD 02 07 020	Pre-galvanized steel heavy 135° angled bracket	60
TD 02 09 020	Pre-galvanized steel heavy 135° angled bracket	60
TD 02 10 525	Pre-galvanized steel heavy 135° angled bracket	40
MU 02 07 015	Pre-galvanized steel rectangular heavy plate with countersunk rounded holes	200
TA 24 01 020	Pre-galvanized steel rectangular heavy plate with nail and screw holes	100
TA 25 51 425	Pre-galvanized steel rectangular heavy plate with nail and screw holes	50
TA 26 51 825	Pre-galvanized steel rectangular heavy plate with nail and screw holes	100
TA 29 02 125	Pre-galvanized steel rectangular heavy plate with nail and screw holes	50
TE 02 08 025	Pre-galvanized steel T-plate with nail and screw holes	50
TE 02 16 025	Pre-galvanized steel T-plate with nail and screw holes	25
KW 20 80 120	Pre-galvanized steel Joist Hanger with Inner Folded Wings	24
KW 20 80 150	Pre-galvanized steel Joist Hanger with Inner Folded Wings	24
KW 20 90 115	Pre-galvanized steel Joist Hanger with Inner Folded Wings	24
KW 20 90 145	Pre-galvanized steel Joist Hanger with Inner Folded Wings	24
KW 21 00 140	Pre-galvanized steel Joist Hanger with Inner Folded Wings	48
KW 21 20 160	Pre-galvanized steel Joist Hanger with Inner Folded Wings	18
KW 21 40 180	Pre-galvanized steel Joist Hanger with Inner Folded Wings	18
KT 20 50 105	Pre-galvanized steel Joist Hanger with Open Wings	24
KT 20 60 100	Pre-galvanized steel Joist Hanger with Open Wings	24
KT 20 70 125	Pre-galvanized steel Joist Hanger with Open Wings	24
KT 20 80 120	Pre-galvanized steel Joist Hanger with Open Wings	24
KT 20 90 145	Pre-galvanized steel Joist Hanger with Open Wings	24
KT 21 00 140	Pre-galvanized steel Joist Hanger with Open Wings	48
KT 21 20 160	Pre-galvanized steel Joist Hanger with Open Wings	18
KT 21 40 180	Pre-galvanized steel Joist Hanger with Open Wings	18
KY 02 30 130	Pre-galvanized steel adjustable joist hanger with open wings	24 (set)
KY 02 40 150	Pre-galvanized steel adjustable joist hanger with open wings	24 (set)
KO 02 40 150	Pre-galvanized steel adjustable joist hanger with inner folded wings	24 (set)
TG 21 01 150	Squared Post holder, Hot Dip Galvanized	8
TR 21 00 150	Round Post holder, Hot Dip Galvanized	10

Total pcs.: 1.709







NH 08 00 002

Six floor wooden display "Expowood", with Woodpecker® wood screws kit

-  Présentoir en bois avec 6 étagères "Expowood" avec sortiment de vis et accessoires pour panneaux de particules
-  Holz- Verkaufsständer mit 6 Ebenen "Expowood", mit Sortiment von Spanplattenschrauben und Zubehör
-  Expositor de madera "Expowood" con surtido de tornillos y arandelas para vigas de madera
-  Деревянный дисплей с 6 полками "Expowood" с ассортиментом шурупов и аксессуаров для ДСП



Kit code	Dimensions	Pcs. per carton
	L x P x h (cm)	
NH 08 00 002	65 x 61 x 186	1

Item code	Description	Pcs. per box	Boxes	Total Pcs.
 TJ0240040	Flat CSK head 6-lobe recess chipboard screws, yellow zinc plated	500	6	3000
TJ0240050	Flat CSK head 6-lobe recess chipboard screws, yellow zinc plated	200	6	1200
TJ0240060	Flat CSK head 6-lobe recess chipboard screws, yellow zinc plated	200	6	1200
TJ0250060	Flat CSK head 6-lobe recess chipboard screws, yellow zinc plated	200	4	800
TJ0250070	Flat CSK head 6-lobe recess chipboard screws, yellow zinc plated	200	4	800
TJ0250080	Flat CSK head 6-lobe recess chipboard screws, yellow zinc plated	200	4	800
TJ0250090	Flat CSK head 6-lobe recess chipboard screws, yellow zinc plated	100	6	600
 TT0206080	Flat CSK head 6-lobe recess screws for structural timber applications, yellow zinc plated	100	2	200
TT0206100	Flat CSK head 6-lobe recess screws for structural timber applications, yellow zinc plated	100	2	200
TT0206140	Flat CSK head 6-lobe recess screws for structural timber applications, yellow zinc plated	100	2	200
TT0206160	Flat CSK head 6-lobe recess screws for structural timber applications, yellow zinc plated	100	2	200
TT0206200	Flat CSK head 6-lobe recess screws for structural timber applications, yellow zinc plated	100	2	200
TT0206240	Flat CSK head 6-lobe recess screws for structural timber applications, yellow zinc plated	50	2	100
TT0206260	Flat CSK head 6-lobe recess screws for structural timber applications, yellow zinc plated	50	2	100
TT0206300	Flat CSK head 6-lobe recess screws for structural timber applications, yellow zinc plated	50	2	100
TT0208080	Flat CSK head 6-lobe recess screws for structural timber applications, yellow zinc plated	100	2	200
TT0208120	Flat CSK head 6-lobe recess screws for structural timber applications, yellow zinc plated	100	2	200
TT0208140	Flat CSK head 6-lobe recess screws for structural timber applications, yellow zinc plated	50	2	100
TT0208180	Flat CSK head 6-lobe recess screws for structural timber applications, yellow zinc plated	50	1	50
TT0208220	Flat CSK head 6-lobe recess screws for structural timber applications, yellow zinc plated	50	1	50
TT0208240	Flat CSK head 6-lobe recess screws for structural timber applications, yellow zinc plated	50	1	50
TT0208300	Flat CSK head 6-lobe recess screws for structural timber applications, yellow zinc plated	50	1	50
TT0210120	Flat CSK head 6-lobe recess screws for structural timber applications, yellow zinc plated	50	1	50
TT0210160	Flat CSK head 6-lobe recess screws for structural timber applications, yellow zinc plated	50	1	50
TT0210200	Flat CSK head 6-lobe recess screws for structural timber applications, yellow zinc plated	50	1	50
TT0210240	Flat CSK head 6-lobe recess screws for structural timber applications, yellow zinc plated	50	1	50
TT0210280	Flat CSK head 6-lobe recess screws for structural timber applications, yellow zinc plated	50	1	50
TT0210340	Flat CSK head 6-lobe recess screws for structural timber applications, yellow zinc plated	50	1	50
TT0210400	Flat CSK head 6-lobe recess screws for structural timber applications, yellow zinc plated	50	1	50
 TT5006080	Flat CSK head 6-lobe recess screws for structural timber applications, A2 stainless steel	100	1	100
TT5006120	Flat CSK head 6-lobe recess screws for structural timber applications, A2 stainless steel	100	1	100
TT5006140	Flat CSK head 6-lobe recess screws for structural timber applications, A2 stainless steel	100	1	100
TT5006160	Flat CSK head 6-lobe recess screws for structural timber applications, A2 stainless steel	100	1	100
TT5006200	Flat CSK head 6-lobe recess screws for structural timber applications, A2 stainless steel	100	1	100
TT5006240	Flat CSK head 6-lobe recess screws for structural timber applications, A2 stainless steel	50	1	50
 TTR0107020	Special conical washer for TT02 Woodpecker® CSK head screw, yellow zinc plated	200	1	200
TTR0109025	Special conical washer for TT02 Woodpecker® CSK head screw, yellow zinc plated	200	1	200
TTR0111030	Special conical washer for TT02 Woodpecker® CSK head screw, yellow zinc plated	200	1	200
TTR5007020	Special conical washer for TT50 Woodpecker® CSK head screw, A2 stainless steel	200	1	200

Total pcs.: 12.100

GH 01

 **ISO 7094 - DIN 440R - Steel plain washer Extra large series, zinc plated**

 ISO 7094 - DIN 440R - Rondelle extra large, en acier zingué

 ISO 7094 - DIN 440R - Extra breite verzinkte Scheibe

 ISO 7094 - DIN 440R - Arandela plana serie Extra ancha, de acero cincado

 ISO 7094 - DIN 440R - Увеличенная шайба из оцинкованной стали

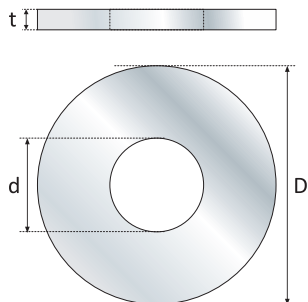

Item code	Size* <i>d x D x t (mm)</i>	For screws: <i>M</i>	Pcs. per box	Pcs. per carton
GH 01 00 008	9 x 28 x 3	M8	500	2500
GH 01 00 010	11 x 34 x 3	M10	300	1500
GH 01 00 012	13,5 x 44 x 4	M12	150	750
GH 01 00 016	17,5 x 56 x 5	M16	75	375
GH 01 00 020	22 x 72 x 6	M20	30	150
GH 01 00 024	26 x 85 x 6	M24	30	150
GH 01 00 030	33 x 105 x 6	M30	15	75

* Tolerances as per ISO 4759-3 / Tolérance selon ISO 4759-3 / Toleranz nach ISO 4759-3 / Tolerancias como en ISO 4759-3 / Отклонения по ISO 4759-3

Box / Boîte / Verpackung / Caja / Упаковка



JZ 01

 **Steel washer for timber structures as in DIN 1052 , zinc plated**

 Rondelle en acier pour structures en bois, comme dans le DIN 1052

 Verzinkte Scheibe für Holzbau, wie in DIN 1052

 Arandela plana para estructuras de madera, como referido en DIN 1052, de acero cincado

 Увеличенная шайба из оцинкованной стали для соединения деревянных элементов по DIN 1052

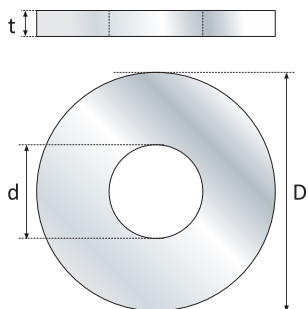

Item code	Size* <i>d x D x t (mm)</i>	For screws: <i>M</i>	Pcs. per box	Pcs. per carton
JZ 01 00 012	14 x 58 x 6	M12	50	250
JZ 01 00 016	18 x 68 x 6	M16	30	150
JZ 01 00 020	22 x 80 x 8	M20	20	100
JZ 01 00 022	25 x 92 x 8	M22	15	75
JZ 01 00 024	27 x 105 x 8	M24	10	50

* Tolerances as per ISO 4759-3 / Tolérance selon ISO 4759-3 / Toleranz nach ISO 4759-3 / Tolerancias como en ISO 4759-3 / Отклонения по ISO 4759-3

Box / Boîte / Verpackung / Caja / Упаковка



CY 01

🇬🇧 **DIN 1587 - Hexagonal domed cap nut, zinc plated**

🇫🇷 DIN 1587 - Écrou borgne à calotte, zingué

🇩🇪 DIN 1587 - Hutmutter, verzinkt

🇪🇸 DIN 1587 - Tuerca ciega de acero cincado

🇷🇺 DIN 1587 - Колпачковая шестигранная гайка из оцинкованной стали

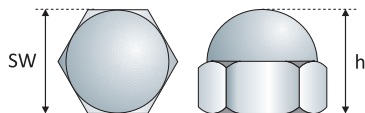

Item code	Size	For screws: M	Pcs. per box	Pcs. per carton
	SW x h (mm)			
CY 01 00 003	5,5 x 6,5	M3	500	10.000
CY 01 00 004	7 x 8	M4	500	10.000
CY 01 00 005	8 x 10	M5	500	5.000
CY 01 00 006	10 x 12	M6	500	5.000
CY 01 00 008	12 x 15	M8	200	2.000
CY 01 00 010	17 x 18	M10	100	1.000
CY 01 00 012	19 x 22	M12	100	1.000
CY 01 00 014	22 x 25	M14	50	500
CY 01 00 016	24 x 28	M16	25	250
CY 01 00 018	27 x 32	M18	25	250
CY 01 00 020	30 x 34	M20	25	250
CY 01 00 022	32 x 39	M22	20	200
CY 01 00 024	36 x 42	M24	15	150

Box / Boîte / Verpackung / Caja / Упаковка



CW 01

🇬🇧 **DIN 1587 - A2 (AISI 304) Stainless steel hexagonal domed cap nut**

🇫🇷 DIN 1587 - Écrou borgne à calotte, en acier inox A2 (AISI 304)

🇩🇪 DIN 1587 - Hutmutter, Edestahl A2 (AISI 304)

🇪🇸 DIN 1587 - Tuerca ciega de acero inoxidable A2 (AISI 304)

🇷🇺 DIN 1587 - Колпачковая шестигранная гайка из нержавеющей стали A2 (AISI 304)

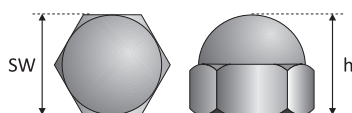

Item code	Size	For screws: M	Pcs. per box	Pcs. per carton
	SW x h (mm)			
CW 01 00 003	5,5 x 5	M3	250	2.500
CW 01 00 004	7 x 8	M4	250	2.500
CW 01 00 005	8 x 10	M5	250	2.500
CW 01 00 006	10 x 12	M6	250	2.500
CW 01 00 008	12 x 15	M8	100	1.000
CW 01 00 010	17 x 18	M10	100	1.000
CW 01 00 012	19 x 22	M12	50	500
CW 01 00 014	22 x 25	M14	25	250
CW 01 00 016	24 x 28	M16	25	250
CW 01 00 018	27 x 32	M18	20	200
CW 01 00 020	30 x 34	M20	20	200
CW 01 00 022	32 x 39	M22	10	100
CW 01 00 024	36 x 42	M24	10	100

Box / Boîte / Verpackung / Caja / Упаковка



